

FEATURES

- -55° to +125°C operation
- 16 to 40 VDC input
- Fully Isolated
- Magnetic feedback
- Fixed frequency
- Topology – Single Ended Forward
- 50 V for up to 50 ms transient protection
- Inhibit and synchronization functions
- Indefinite short circuit protection
- Up to 84% efficiency, 21 watts/in³

DC/DC CONVERTERS 28 VOLT INPUT

MHD SERIES 20 WATT



MODELS	
VDC OUTPUT	
SINGLE	DUAL
5	±5
12	±12
15	±15
18	

Size (max.): Non-flanged, case H2
2.125 x 1.125 x 0.400 inches (53.98 x 28.58 x 10.16 mm)
Flanged case, K3
2.910 x 1.125 x 0.400 inches (73.91 x 28.58 x 10.16 mm)
See Section B8, cases H2 and K3 for dimensions.
Weight: 52 grams max., flanged 55 grams max.
Screening: Standard, ES, or 883 (Class H). See Section C2 for screening options, see Section A5 for ordering information.

DESCRIPTION

The MHD Series™ of DC/DC converters offers up to 20 watts of output power over the full military temperature range with up to 84% efficiency. Thick-film hybrid techniques provide military/aerospace reliability levels and optimum miniaturization. The MHD Series power density rating is up to 21 watts/in³.

MHD converters are packaged in hermetically sealed metal cases, making them ideal for use in military, aerospace and other high reliability applications. Units are available with standard screening, "ES" screening, or fully compliant SMD versions (see Section C2 for screening conditions).

CONVERTER DESIGN

The MHD converters are constant frequency, pulse-width modulated switching regulators which use a quasi-square wave, single ended, forward converter design. Tight load regulation (5 mV typical) is maintained via wide bandwidth magnetic feedback and, on single output models, through use of remote sense. On dual output models, the positive output is independently regulated and the negative output is cross regulated through the use of tightly coupled magnetics and shunt regulators.

Indefinite short circuit protection and overload protection are provided by a constant current-limit feature. This protective system senses current in the converter's secondary stage and limits it to approximately 115% of the maximum rated output current.

MHD converters are provided with internal filtering capacitors that help reduce the need for external components in normal operation. For systems that require compliance with MIL-STD-461C's CE03 standard, Interpoint offers filter/transient suppression modules (including the FMC-461, FMD-461 and FM-704A series filters) which will result in compliance. Contact your Interpoint representative for further details.

SYNCHRONIZATION

The MHD offers a synchronization feature that allows the designer to match the switching frequency of the converter to the frequency of the system clock. In free-run (unsynchronized) mode, the MHD unit switches at 625 kHz (nominal). In sync mode, the converter will run at any frequency between 500 kHz and 675 kHz. The sync control operates with a quasi-TTL signal at any duty cycle between 40% and 60%.

Synchronizing the converter with the system clock allows the designer to confine switching noise to clock transitions, minimizing interference and reducing the need for filtering. The sync pin should be connected to input common pin when not in use.

WIDE VOLTAGE RANGE

The MHD converters are designed to provide full power operation over a full 16 to 40 VDC voltage range. Operation below 16 volts, including MIL-STD-704E emergency power conditions is possible with derated power. Refer to the low line dropout graph (Figure 15) for details.

IMPROVED DYNAMIC RESPONSE

The MHD feed-forward compensation system provides excellent dynamic response and noise rejection. Audio rejection is typically 50 dB. The min. to maximum step line transient response is typically less than 4%.

INHIBIT FUNCTION

MHD converters provide an inhibit terminal that can be used to disable internal switching, resulting in no output and very low quiescent input current. The converter is inhibited when a TTL compatible low (≤ 0.8 V) is applied to the inhibit pin. The unit is enabled when the pin, which is internally connected to a pull-up resistor, is left unconnected or is connected to an open-collector gate. The open circuit output voltage associated with the inhibit pin is 9 to 11 V. In the inhibit mode, a maximum of 8 mA must be sunk from the inhibit pin.

MHD SERIES 20 WATT

DC/DC CONVERTERS

ABSOLUTE MAXIMUM RATINGS

Input Voltage

- 16 to 40 V

Output Power

- 15 to 20 watts depending on model

Lead Soldering Temperature (10 sec per lead)

- 300°C

Storage Temperature Range (Case)

- -65°C to +150°C

RECOMMENDED OPERATING CONDITIONS

Input Voltage Range

- 16 to 40 VDC continuous
- 50 V for up to 50 msec transient

Case Operating Temperature (Tc)

- -55°C to +125°C Full power
- -55°C to +135°C Absolute

Derating Output Power/Current

- Linearly from 100% at 125°C to 0% at 135°C

SYNC AND INHIBIT

Sync (500 to 675 kHz)

- Duty cycle 40% min, 60% max
- Logic low 0.8 V max, 0.0 V min
- Logic high 4.0 V min, 10 V max
- Referenced to input common
- If not used, connect to input common

Inhibit: TTL Open Collector

- Logic low (output disabled)
Logic low voltage ≤ 0.8 V
Inhibit pin current 8.0 mA max
- Referenced to input common
- Logic high (output enabled)
Open collector

TYPICAL CHARACTERISTICS

Output Voltage Temperature Coefficient

- 100 ppm/°C typical

Input to Output Capacitance

- 50 pF typical

Current Limit

- 115% of full load typical

Isolation

- 100 megohm minimum at 500 V

Audio Rejection

- 50 dB typical

Conversion Frequency

- Free run mode 625 kHz typical
- 550 kHz. min, 650 kHz max
- External sync range 500 to 675 kHz

Inhibit Pin Voltage (unit enabled)

- 9 to 11 V

Electrical Characteristics: 25°C Tc, 28 VDC Vin, 100% load, free run, unless otherwise specified.

SINGLE OUTPUT MODELS		MHD2805S			MHD2812S			MHD2815S			MHD2818S			UNITS
PARAMETER	CONDITION	MIN	TYP	MAX	MIN	TYP	MAX	MIN	TYP	MAX	MIN	TYP	MAX	
OUTPUT VOLTAGE		4.95	5.00	5.05	11.88	12.00	12.12	14.85	15.00	15.15	17.82	18.00	18.18	VDC
OUTPUT CURRENT ¹	V _{IN} = 16 to 40 VDC	0	—	3	0	—	1.67	0	—	1.33	0	—	1.11	A
OUTPUT POWER ¹	V _{IN} = 16 to 40 VDC	0	—	15	0	—	20	0	—	20	0	—	20	W
OUTPUT RIPPLE VOLTAGE	10 kHz – 2 MHz Tc = -55°C TO +125°C	—	35	50	—	25	40	—	25	40	—	—	40	mV p
LINE REGULATION ²	V _{IN} = 16 to 40 VDC Tc = -55°C TO +125°C	—	10	50	—	10	50	—	10	50	—	—	50	mV
LOAD REGULATION	NO LOAD TO FULL Tc = -55°C TO +125°C	—	5	50	—	5	50	—	5	50	—	—	50	mV
INPUT VOLTAGE ¹	CONTINUOUS	16	28	40	16	28	40	16	28	40	16	28	40	VDC
NO LOAD TO FULL	TRANSIENT 50 ms	—	—	50	—	—	50	—	—	50	—	—	50	V
INPUT CURRENT	NO LOAD ¹	—	35	75	—	35	75	—	35	75	—	—	75	mA
	FULL LOAD	—	0.70	—	—	0.87	—	—	0.85	—	—	—	—	A
	INHIBITED ¹	—	7	8	—	7	8	—	7	8	—	—	8	mA
INPUT RIPPLE CURRENT	10 kHz – 10 MHz Tc = -55°C TO +125°C	—	20	50	—	20	50	—	20	50	—	—	50	mA p-p
EFFICIENCY		76	78	—	80	83	—	81	84	—	81	—	—	%
LOAD FAULT ³	SHORT CIRCUIT	—	—	10	—	—	10	—	—	10	—	—	10	A
SHORT CIRCUIT TO FULL LOAD	POWER DISSIPATION RECOVERY ^{1, 3}	—	1.4	5	—	1.4	5	—	1.4	5	—	—	5	ms
STEP LOAD RESP. TRANSIENT	50% – 100% – 50%	—	±200	±300	—	±250	±400	—	±350	±500	—	—	±600	mV pk
	10% – 100%	—	-400	-600	—	-600	-1000	—	-800	-1200	—	—	—	
	100% – 10%	—	+350	+600	—	+500	+750	—	+600	+1000	—	—	—	
RECOVERY ⁴	50% – 100% – 50%	—	60	200	—	60	200	—	60	200	—	—	200	µs
	10% – 100%	—	60	600	—	150	300	—	250	500	—	—	—	
	100% – 10%	—	200	600	—	250	500	—	250	500	—	—	—	
STEP LINE RESP.	16 – 40 – 16 VDC													
	TRANSIENT ⁵	—	±200	±300	—	±400	±500	—	±500	±600	—	—	±600	mV pk
	RECOVERY ⁴	—	—	300	—	—	300	—	—	300	—	—	300	µs
START-UP ¹	DELAY	—	1.4	5	—	1.4	5	—	1.4	5	—	—	5	ms
	OVERSHOOT													
	FULL LOAD	—	0	50	—	0	120	—	0	150	—	—	180	mV pk
	NO LOAD	—	50	250	—	120	600	—	150	750	—	—	—	

Notes

1. Tc = -55°C to +125°C
2. Operation is limited below 16V (see Figure 15).
3. Indefinite short circuit protection not guaranteed above 125°C case.
4. Recovery time is measured from application of the transient to point at which Vout is within 1% of final value.
5. Transition time ≥ 10 µs.

DC/DC CONVERTERS

MHD SERIES 20 WATT

Electrical Characteristics: 25°C Tc, 28 VDC Vin, 100% load, free run, unless otherwise specified.

DUAL OUTPUT MODELS		MHD2805D			MHD2812D			MHD2815D			UNITS	
PARAMETER	CONDITIONS	MIN	TYP	MAX	MIN	TYP	MAX	MIN	TYP	MAX		
OUTPUT VOLTAGE ¹		+V _{OUT}	4.95	5.00	5.05	11.88	12.00	12.12	14.85	15.00	15.15	VDC
		-V _{OUT}	4.925	5.00	5.075	11.82	12.00	12.18	14.77	15.00	15.23	
OUTPUT CURRENT ^{1,2}	V _{IN} = 16 TO 40 VDC	0.30	—	3.0	0.13	—	1.25	0.10	—	1.00	A	
OUTPUT POWER ^{1,2}	V _{IN} = 16 TO 40 VDC	0	—	15	0	—	15	0	—	15	W	
OUTPUT RIPPLE VOLTAGE	10 kHz - 2 MHz	—	20	50	—	30	80	—	25	80	mV p-p	
+/- V _{OUT}	Tc = -55°C TO +125°C	—	40	80	—	40	120	—	40	120		
LINE REGULATION ³	V _{IN} = 16 TO 40 VDC	Tc = -55°C +V _{OUT}	—	10	50	—	10	50	—	10	50	mV
		TO +125°C -V _{OUT}	—	50	100	—	50	150	—	50	180	
LOAD REGULATION	Tc = -55°C TO +125°C	+V _{OUT}	—	5	50	—	15	50	—	15	50	mV
		-V _{OUT}	—	25	100	—	30	150	—	30	180	
CROSS REGULATION	SEE NOTE 4	—	7	12	—	4	8.3	—	3	8	%	
EFFECT ON -V _{OUT}	SEE NOTE 5	—	4	6	—	4	6	—	4	6		
INPUT VOLTAGE ¹	CONTINUOUS	16	28	40	16	28	40	16	28	40	VDC	
NO LOAD TO FULL	TRANSIENT 50 ms	0	—	50	0	—	50	0	—	50	V	
INPUT CURRENT	NO LOAD ¹	—	35	75	—	50	75	—	50	75	mA	
	FULL LOAD	—	0.70	—	—	0.88	—	—	0.86	—	A	
	INHIBITED ¹	—	7	8	—	7	8	—	7	8	mA	
INPUT RIPPLE CURRENT ¹	10 kHz - 10 MHz	—	15	50	—	20	50	—	20	50	mA p-p	
EFFICIENCY	POWER DISSIPATION	76	78	—	79	81	—	80	83	—	%	
	SHORT CIRCUIT RECOVERY ^{1, 7}	—	1.4	5.0	—	1.4	5.0	—	1.4	5.0		
STEP LOAD RESPONSE ± V _{OUT}	TRANSIENT	—	±200	±300	—	±150	±300	—	±200	±400	mV pk	
	50 - 100 - 50%	—	±400	±600	—	±200	±400	—	±300	±500		
	RECOVERY ⁷	—	100	200	—	100	200	—	100	200	μs	
	50 - 100 - 50%	—	400	600	—	100	200	—	200	250		
STEP LINE RESPONSE ± V _{OUT}	16 - 40 - 16 V _{IN} TRANSIENT ⁸	—	±200	±400	—	±200	±400	—	±400	±500	mV pk	
	RECOVERY ⁷	—	—	300	—	—	300	—	—	300	μs	
START-UP	DELAY	—	1.4	5	—	1.4	5	—	1.4	5	ms	
	OVERSHOOT	—	0	50	—	0	120	—	0	150	mV pk	
	NO LOAD	—	50	250	—	120	600	—	150	750		

Notes

- Tc = -55°C to +125°C.
- Up to 90% of the total output current/power is available from either output. The minimum load on the positive output is 10% of full load.
- Operation is limited below 16 V (see Figure 15).
- Effect on the negative output under the following conditions:
+Pout 20% to 80%; -Pout 80% to 20%
- Effect on the negative output under the following conditions:
+Pout 50%; -Pout 10% to 50%
- Indefinite short circuit protection not guaranteed above 125°C case.
- Recovery time is measured from application of the transient to point at which Vout is within 1% of final value.
- Transition time ≥ 10 μs.

MHD SERIES 20 WATT

DC/DC CONVERTERS

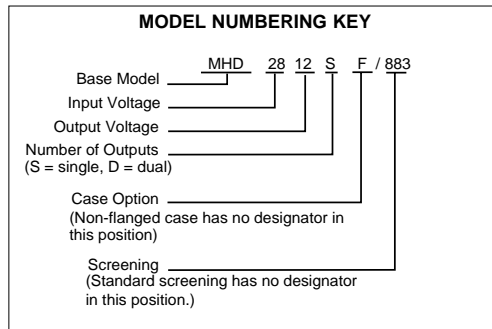
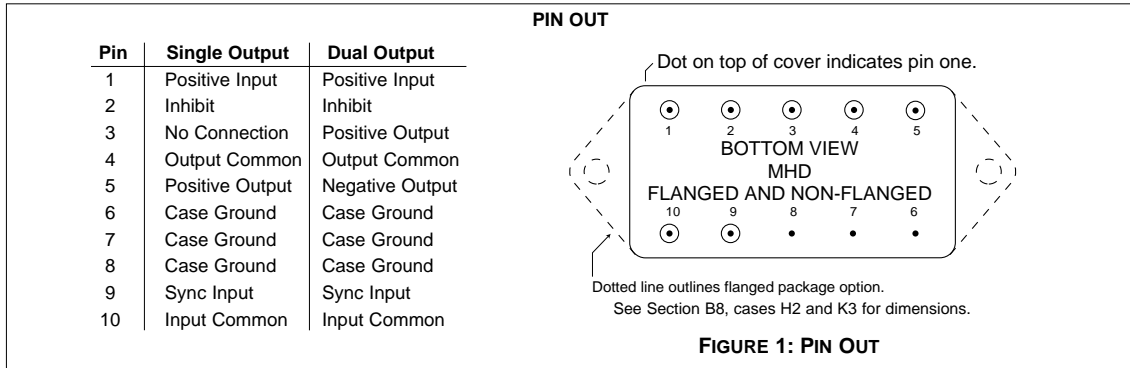

SMD NUMBERS	
STANDARD MICROCIRCUIT DRAWING (SMD)	MHD SIMILAR MODEL NUMBER
NON-FLANGED CASE	
5962-9465501HXC	MHD2805S/883
5962-9465601HXC	MHD2812S/883
5962-9465701HXC	MHD2815S/883
5962-9465801HXC	MHD2818S/883
5962-9465901HXC	MHD2805D/883
5962-9466001HXC	MHD2812D/883
5962-9466101HXC	MHD2815D/883
FLANGED CASE	
5962-9465501HZC	MHD2805SF/883
5962-9465601HZC	MHD2812SF/883
5962-9465701HZC	MHD2815SF/883
5962-9465801HZC	MHD2818SF/883
5962-9465901HZC	MHD2805DF/883
5962-9466001HZC	MHD2812DF/883
5962-9466101HZC	MHD2815DF/883

For exact specifications for an SMD product, refer to the SMD drawing. See Section A3, SMDs, for more information.

DC/DC CONVERTERS

MHD SERIES 20 WATT

Typical Performance Curves: 25°C Tc , 28 VDC Vin, 100% load, free run, unless otherwise specified.

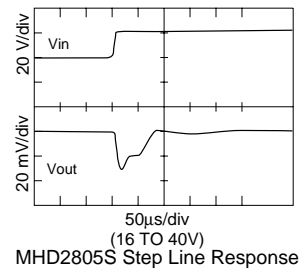
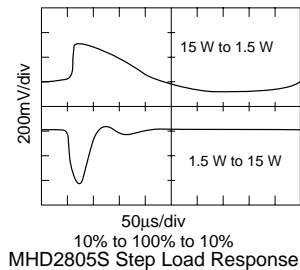
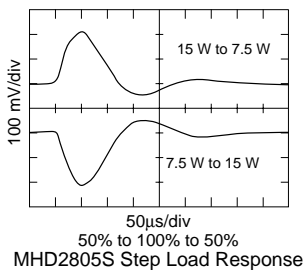
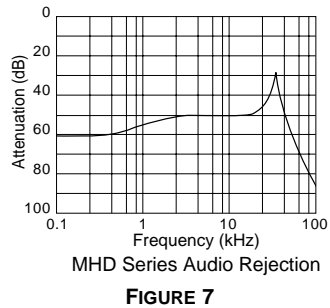
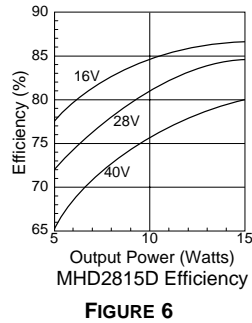
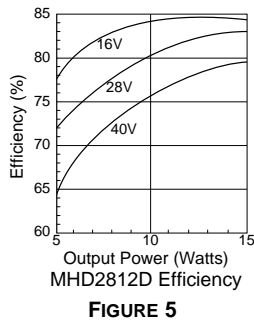
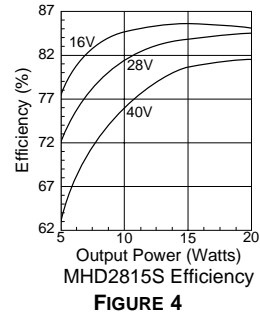
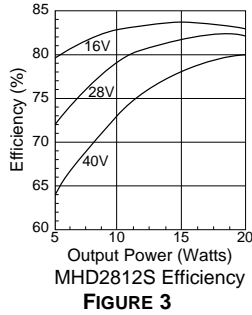
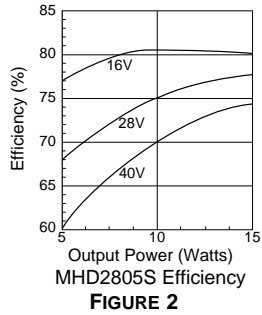

MHD SERIES 20 WATT

DC/DC CONVERTERS

Typical Performance Curves: 25°C Tc , 28 VDC Vin, 100% load, free run, unless otherwise specified.

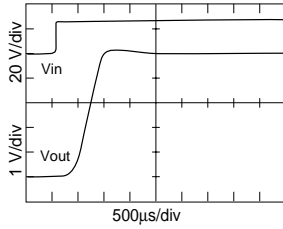

MHD2805S Turn On Into No Load

FIGURE 11

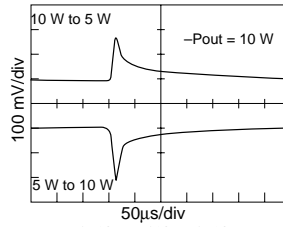

MHD2815D +Vout Step Load Response

FIGURE 12

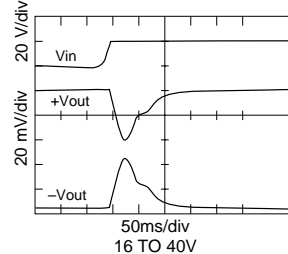

MHD2815D Step Line Response

FIGURE 13

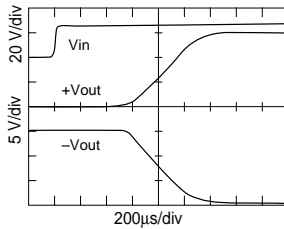

MHD2815D Turn On Into No Load

FIGURE 14

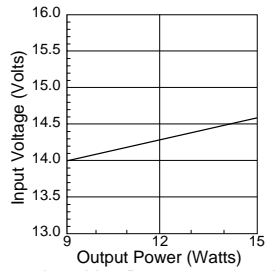

Low Line Dropout vs. Load

FIGURE 15

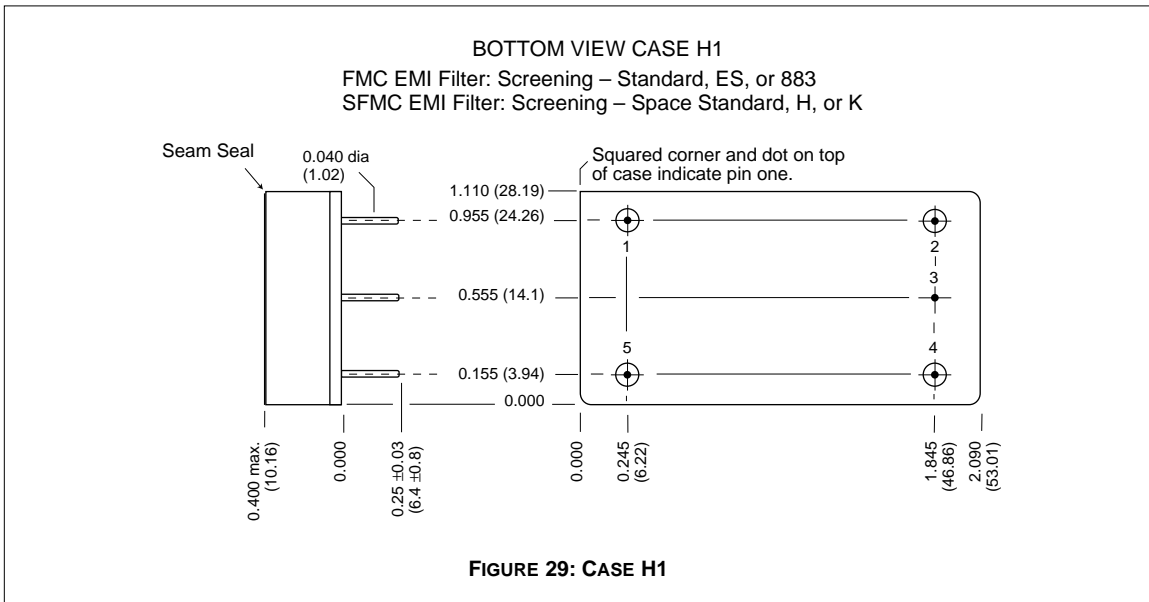
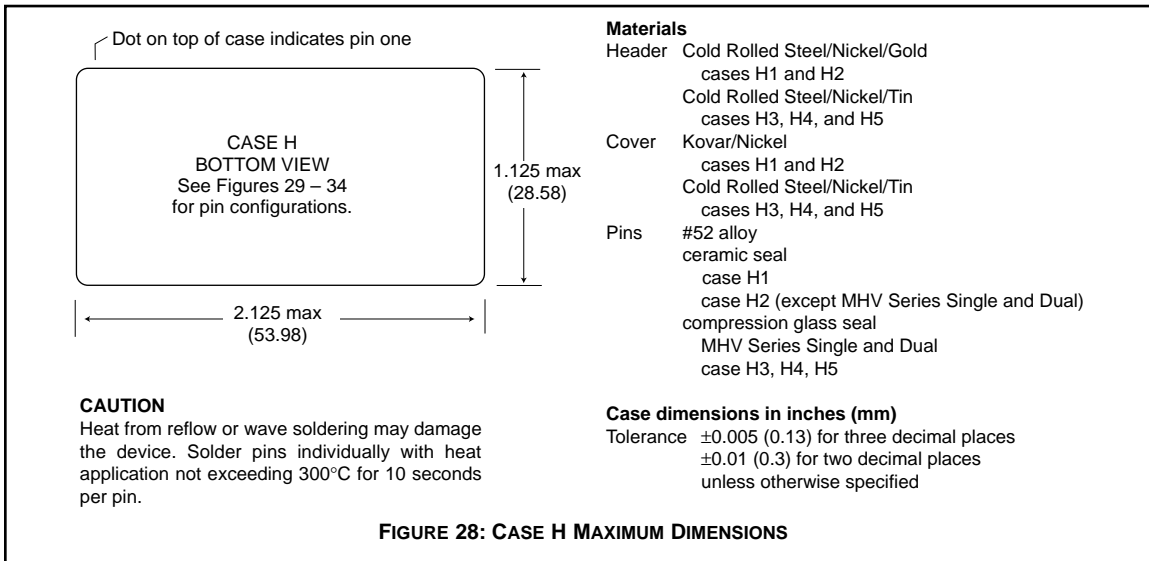

Note: Although every effort has been made to render the case drawings at actual size, variations in the printing process may cause some distortion. Please refer to the numerical dimensions for accuracy.

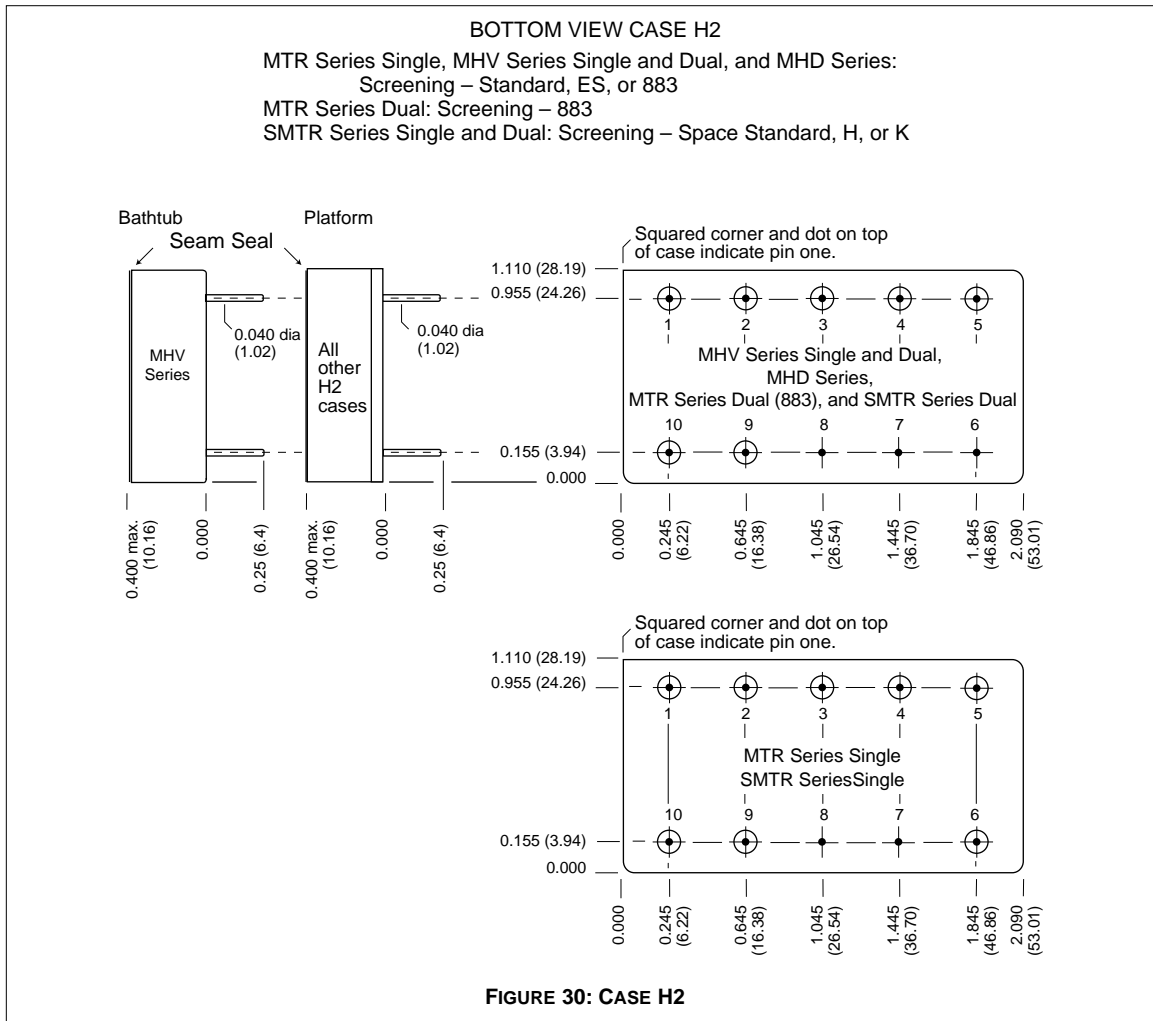
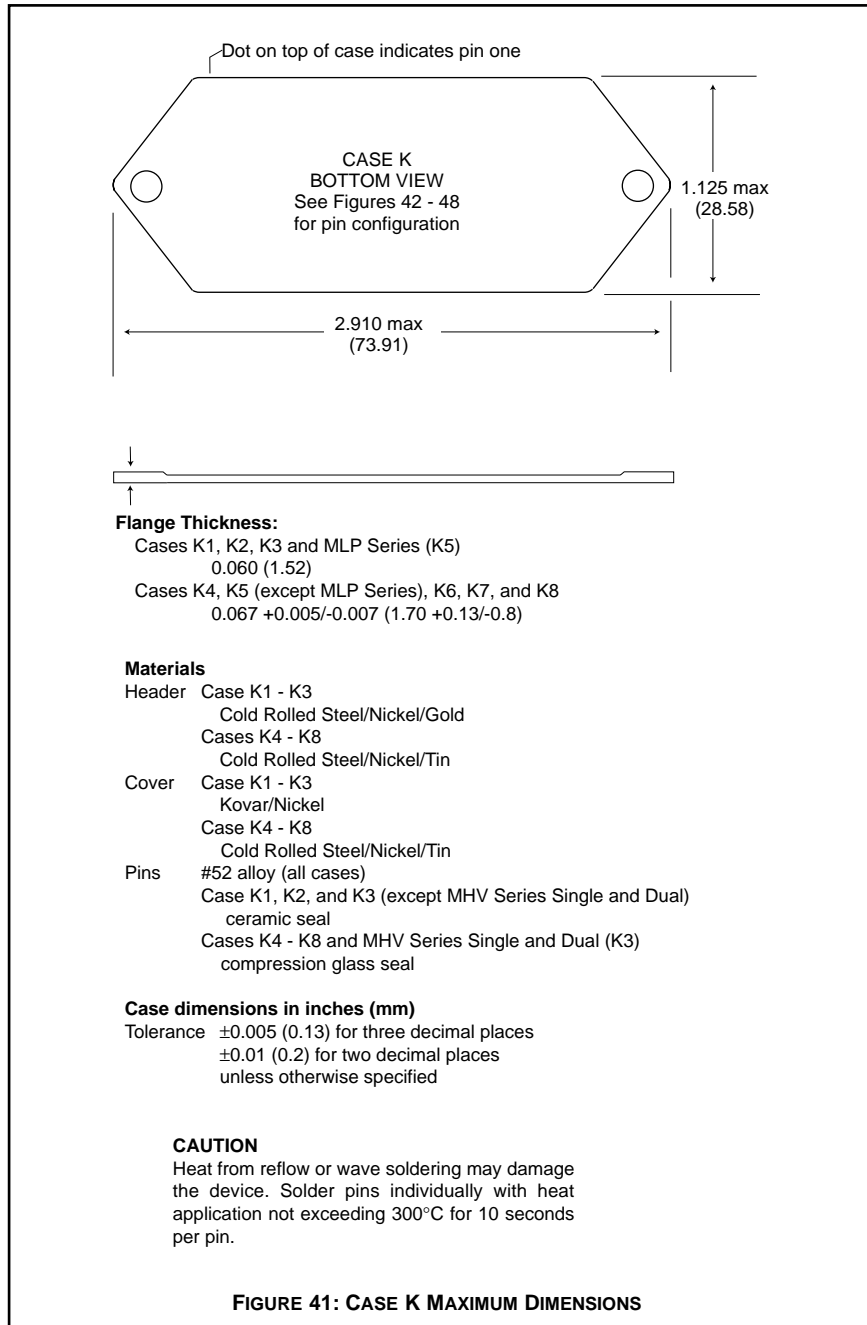

FIGURE 30: CASE H2

CASE K

CASES



BOTTOM VIEW CASE K3

Flanged cases: Designator required in Case Option position of model number.
 MTR Series Single, MHV Series Single and Dual, MHD Series:
 Screening – Standard, ES, or 883
 MTR Series Dual: Screening – 883
 SMTR Series: Screening – Space Standard, H, or K

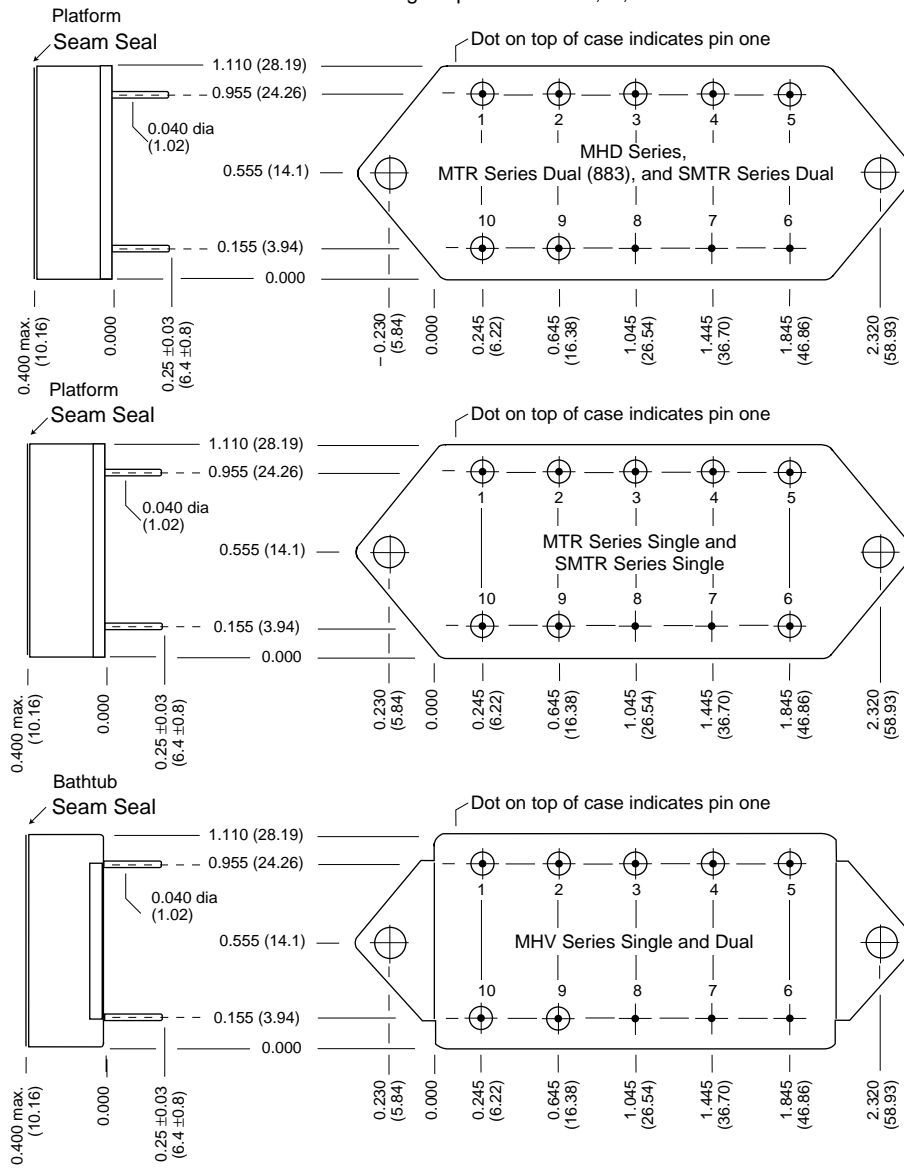

FIGURE 44: CASE K3

QA SCREENING 125°C PRODUCTS

125°C PRODUCTS

TEST (125°C Products)	STANDARD	/ES	/883 (Class H)*
PRE-CAP INSPECTION Method 2017, 2032	yes	yes	yes
TEMPERATURE CYCLE (10 times) Method 1010, Cond. C, -65°C to 150°C Method 1010, Cond. B, -55°C to 125°C	no no	no yes	yes no
CONSTANT ACCELERATION Method 2001, 3000 g Method 2001, 500 g	no no	no yes	yes no
BURN-IN Method 1015, 160 hours at 125°C 96 hours at 125°C case (typical)	no no	no yes	yes no
FINAL ELECTRICAL TEST MIL-PRF-38534, Group A Subgroups 1 through 6: -55°C, +25°C, +125°C Subgroups 1 and 4: +25°C case	no yes	no yes	yes no
HERMETICITY TESTING Fine Leak, Method 1014, Cond. A Gross Leak, Method 1014, Cond. C Gross Leak, Dip (1 x 10 ⁻³)	no no yes	yes yes no	yes yes no
FINAL VISUAL INSPECTION Method 2009	yes	yes	yes

Test methods are referenced to MIL-STD-883 as determined by MIL-PRF-38534.

*883 products are built with element evaluated components and are 100% tested and guaranteed over the full military temperature range of -55°C to +125°C.

Applies to the following products

MOR Series	MHD Series	MGH Series	FMGA EMI Filter
MFLHP Series	MHV Series	MCH Series	FMSA EMI Filter
MFL Series	MHF+ Series	FM-704A EMI Filter	HUM Modules**
MHP Series	MHF Series**	FMD**/FME EMI Filter	LCM Modules**
MTR Series	MGA Series	FMC EMI Filter	LIM Modules
MQO Series**	MSA Series	FMH EMI Filter	

**MFLHP Series, MQO Series, MHF Series, FMD EMI Filters, Hum Modules, and LCM Modules do not offer '883' screening.