

# MOR Single and Dual DC/DC Converters

## 28 VOLT INPUT – 120 WATT

### FEATURES

- -55° to +125°C operation
- 16 to 40 VDC input
- Fully isolated
- Magnetic feedback
- Fixed frequency 550 kHz typical
- Topology – Single Ended Forward
- Will withstand transients of up to 50 V for up to 120 msec.
- Output trim 60% to 110%
- Input and output side inhibit
- Remote sense
- Synchronization
- Parallel up to 5 units
- Output short circuit protection
- Up to 80 W/in<sup>3</sup>, 87% efficiency



### MODELS

#### VDC OUTPUT

SINGLES	DUALS
3.3	±3.3
5	±5
6.3	±6.3
9.5	±9.5
12	±12
15	±15

### DESCRIPTION

With up to 120 watts of output power, the MOR Series™ of DC/DC converters operates from a standard 28 volt bus and offers a wide input range of 16 to 40 VDC. Full operation over the military temperature range, -55°C to +125°C, makes the MOR Series an ideal choice for military, aerospace, space, and other high reliability applications. In compliance with MIL-STD-704D, the converters will withstand transients of up to 50 volts for up to 120 milliseconds. Use Interpoint's FME28-461 EMI filter to pass MIL-STD-461C, CE03 requirements.

The MOR Series converters incorporate a single-ended forward topology which uses a constant frequency Pulse Width Modulator

(PWM) current mode control design and switches at 550 kHz, nominal. The converters also provide short circuit protection by restricting the current to 125% of the full load output current. All models offer two inhibits, one referenced to input common and one referenced to output common. A remote sense function is available on single output models.

Using the trim function, the MOR Series can provide any output from 2 to 33 VDC. For example, trimming the two 15 volt outputs of the 15 dual (MOR2815D) to 14 volts, and then stacking the outputs will provide a 28 volt output.



# MOR Single and Dual DC/DC Converters

## 28 VOLT INPUT – 120 WATT

PIN OUT		
Pin	Single Output	Dual Output
1	Positive Input	Positive Input
2	Input Common	Input Common
3	Trim	Case
4	Inhibit 1 (INH1)	Inhibit 1 (INH1)
5	Sync Out	Sync Out
6	Sync In	Sync In
7	Positive Output	Positive Output
8	Output Common	Output Common
9	Sense Return	Negative Output
10	Positive Sense	Trim
11	Share	Share
12	Inhibit 2 (INH2)	Inhibit 2 (INH2)

PINS NOT IN USE	
Trim	Leave unconnected
Case	User's discretion
Inhibit (INH1, INH2)	Leave unconnected
Sync Out	Leave unconnected
Sync In	Connect to input common
Share	Leave unconnected
Sense Lines	Must be connected to appropriate outputs

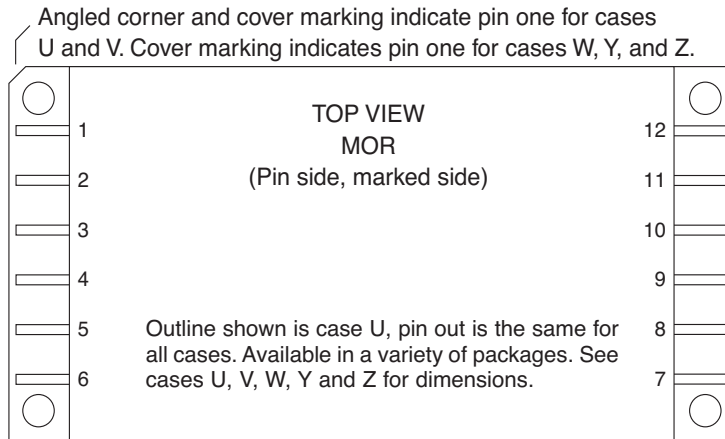

**FIGURE 2: PIN OUT TOP VIEW**

# MOR Single and Dual DC/DC Converters

## 28 VOLT INPUT – 120 WATT

### HOW TO USE FUNCTIONS

#### POSITIVE INPUT AND INPUT COMMON

Steady state voltage range is 16 to 40 VDC. Transient range is 40 to 50 V for a maximum of 120 msec. Low voltage lockout prevents the units from operating below approximately 15.5 VDC input voltage to keep system current levels smooth, especially during initialization or re-start operations. All models include a soft-start function to prevent large current draw and minimize overshoot.

#### CASE AND EXTERNAL INPUT FILTERS

Internal 500 V capacitors are connected between the case and input common and between the case and output common. See Figure 3.

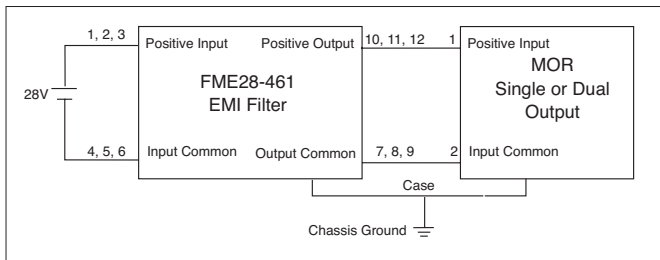

FIGURE 3: EXTERNAL FILTER CONNECTION

Interpoint's FME filters are recommended to meet CE03 requirements for reflected input line current. When using an external input filter it is important that the case of the filter and the case of the converter be connected through as low as an impedance as possible. Direct connection of the baseplates to chassis ground is the best connection. If connected by a single trace, the trace should be as wide as it is long.

#### TRIM

Both single and dual output models include a trim function. Output voltage can be trimmed from 60% up to 110% of nominal V out . When trimming up, do not exceed the maximum output power. When trimming down, do not exceed the maximum output current. See Figure 4.

On dual models the positive output is regulated and the negative output is transformer coupled (cross-regulated) to the positive output. When trimming the duals, both output voltages will be adjusted equally. See Figure 5.

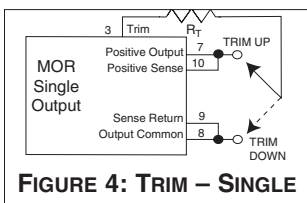

FIGURE 4: TRIM – SINGLE

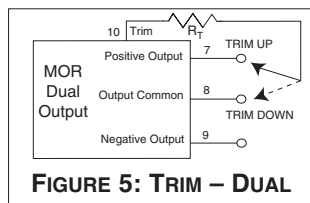

FIGURE 5: TRIM – DUAL

### TRIM FORMULAS

#### Trim Up:

$$\alpha = \frac{V_o}{V_{o \text{ nominal}}} , 1.0 \leq \alpha \leq 1.1$$

$$R_T \text{ (k}\Omega\text{)} = \frac{\left( \frac{V_o}{2.5} - 1 \right) \cdot 20}{(\alpha - 1)} - 50$$

#### Example:

$$V_{o \text{ nominal}} = 5.0, V_o = 5.25, \alpha = 1.05, R_T = 390 \text{ k}\Omega$$

#### Trim Down:

$$\alpha = \frac{V_o}{V_{o \text{ nominal}}} , 0.6 \leq \alpha \leq 1.0$$

$$R_T \text{ (k}\Omega\text{)} = \frac{50 \cdot \alpha - 30}{1 - \alpha}$$

$$\text{Example: } V_{o \text{ nominal}} = 5.0, V_o = 4.5, \alpha = 0.9, R_T = 150 \text{ k}\Omega$$

### INHIBIT 1 AND 2

Two inhibit terminals disable switching, resulting in no output and very low quiescent input current. The two inhibit pins allow access to an inhibit function on either side of the isolation barrier to help maintain isolation.

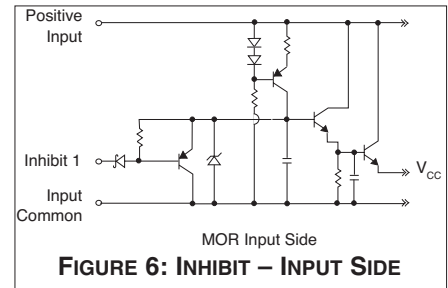

FIGURE 6: INHIBIT – INPUT SIDE

An open collector is required for interfacing with both of the inhibit pins. Applying an open-collector TTL logic low to either

inhibit pin will inhibit the converter. Applying an open collector TTL logic high or leaving the pins open will enable the converter. Inhibit 1 is referenced to Input Common, while Inhibit 2 is referenced to Sense Return on the output side.

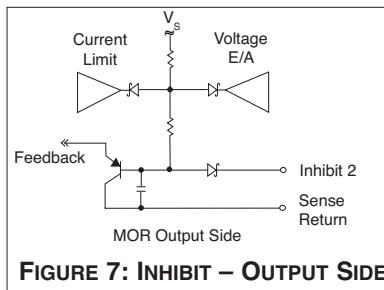

FIGURE 7: INHIBIT – OUTPUT SIDE

Inhibit 2 it is 8 V. Float the inhibit pin(s) if not used. The required logic low voltage level is 0.2 V maximum.

See Figures 6 and 7.

# MOR Single and Dual DC/DC Converters

## 28 VOLT INPUT – 120 WATT

### SYNC IN AND SYNC OUT

The MOR converters can be synchronized to the system clock by applying a TTL compatible sync signal to the Sync In pin. Sync Out can be used to synchronize other components to the MOR converter's switching frequency.

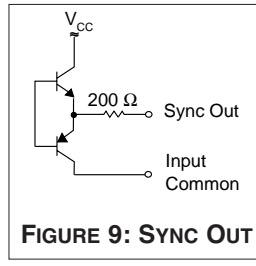
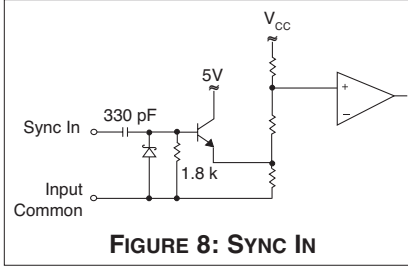

The frequency range for external synchronization is 525 to 625 kHz. The requirements for an external signal are 15% to 50% duty cycle,  $0 \leq L \leq 0.8$  V and  $4.5 \leq H \leq 9$  V. Both Sync In and Sync Out are referenced to input common. Sync In should be grounded to input common if not used. See Figures 8 and 9.

### POSITIVE SENSE, SENSE RETURN

A special remote sensing feature maintains the desired output voltage at the load. See Figure 12. When this feature is not used, connect the sense lines to their respective output terminals. See Figure 13. Remote sensing is available on single output models only. Do not exceed 110% of  $V_{out}$  and maximum output power.

### SHARE (PARALLELING)

By using the Share pin, up to five single or dual converters may be paralleled for a total output power of over 500 watts (90%  $P_{out}$  / converter, max.). The converters will share within 10% of each other at 25 to 90% rated power. MOR converters feature true n+1 redundancy for reliability in critical applications. See Figure 10 for the proper connections.

All Positive Outputs and Positive Senses should be connected to a common point. All Negative Outputs and Sense Returns should be connected to a common point. The Share pin is referenced to Sense Return. Leave the share pin floating (unconnected) if not used. Also see Figure 12.

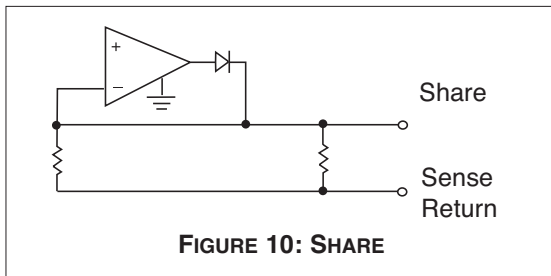

### POSITIVE OUTPUT, NEGATIVE OUTPUT AND OUTPUT COMMON

Output current is limited to 125% of maximum specified current under short circuit or load fault conditions.

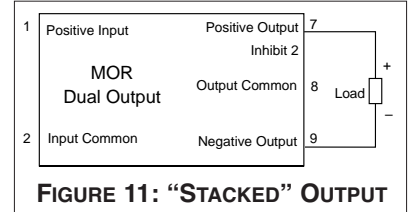

Single output models operate from no load to full load. Dual output models with balanced loads operate from no load to full load. For dual models with unbalanced loads, at least 10% of the total output power must be drawn from the positive output at all times, however, the negative output does not require a minimum load. See note 7, cross regulation, under the Electrical Characteristics Tables. Dual outputs may be "stacked" to double the output voltage. See Figure 11.

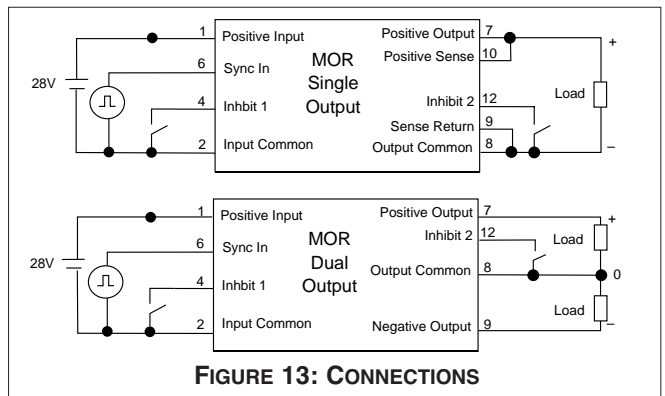
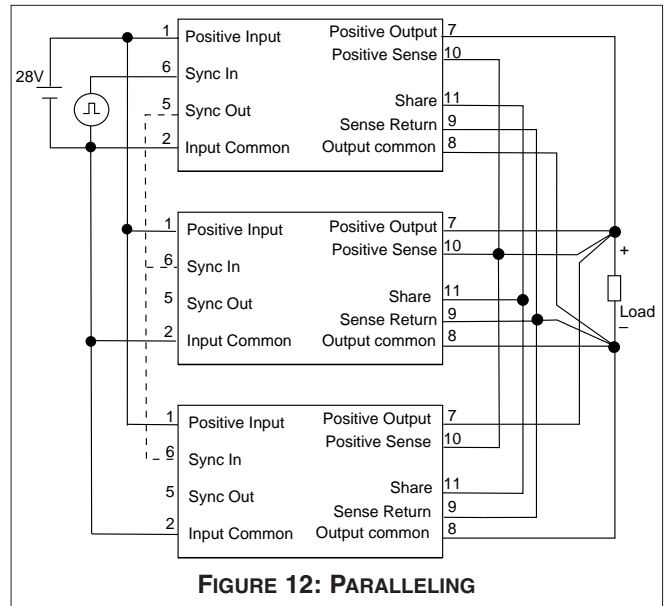



# MOR Single and Dual DC/DC Converters

## 28 VOLT INPUT – 120 WATT

Electrical Characteristics: 25°C Tc, 28 VDC Vin, 100% load, free run, unless otherwise specified.

SINGLE OUTPUT MODELS		MOR283R3S			MOR2805S			MOR286R3S			MOR289R5S			UNITS
PARAMETER	CONDITION	MIN	TYP	MAX	MIN	TYP	MAX	MIN	TYP	MAX	MIN	TYP	MAX	
OUTPUT VOLTAGE		3.25	3.30	3.35	4.95	5.00	5.05	6.24	6.30	6.36	9.40	9.50	9.60	VDC
OUTPUT CURRENT	V <sub>IN</sub> = 16 to 40 VDC	0	—	20	0	—	20	0	—	16	0	—	11	A
OUTPUT POWER	V <sub>IN</sub> = 16 to 40 VDC	0	—	66	0	—	100	0	—	100	0	—	105	W
OUTPUT RIPPLE VOLTAGE	10 kHz - 20 MHz	—	30	80	—	30	80	—	75	100	—	75	120	mV p-p
	Tc = -55°C to +125°C	—	30	80	—	30	80	—	75	100	—	75	120	
	10 kHz - 2 MHz	—	20	50	—	20	50	—	50	60	—	50	80	
LINE REGULATION	V <sub>IN</sub> = 16 to 40 VDC	—	0	20	—	0	20	—	0	20	—	0	20	mV
LOAD REGULATION	NO LOAD TO FULL	—	0	20	—	0	20	—	0	20	—	0	30	mV
INPUT VOLTAGE	CONTINUOUS	16	28	40	16	28	40	16	28	40	16	28	40	VDC
	TRANSIENT 120 ms <sup>1</sup>	—	—	50	—	—	50	—	—	50	—	—	50	V
INPUT CURRENT	NO LOAD	—	70	130	—	70	130	—	70	130	—	70	130	mA
	INHIBITED - INH1	—	—	10	—	—	10	—	—	10	—	—	10	mA
	INHIBITED - INH2	—	—	70	—	—	70	—	—	70	—	—	70	
INPUT RIPPLE CURRENT	10 kHz - 20 MHz Tc = -55°C to +125°C	—	40	90	—	50	130	—	50	100	—	50	130	mA pp
EFFICIENCY		74	78	—	78	81	—	81	83	—	81	84	—	%
LOAD FAULT	POWER DISSIPATION OVERLOAD	—	27	—	—	30	—	—	30	—	—	30	—	W
	SHORT CIRCUIT <sup>2</sup>	—	—	22	—	—	27	—	—	24	—	—	24	ms
	RECOVERY <sup>1</sup>	—	—	10	—	—	10	—	—	10	—	—	10	
STEP LOAD RESP.	50% – 100% – 50%	—	—	250	—	—	250	—	—	500	—	—	500	mV pk
	TRANSIENT	—	—	250	—	—	250	—	—	500	—	—	500	μs
	RECOVERY <sup>3</sup>	—	—	200	—	—	200	—	—	300	—	—	300	
STEP LINE RESP.	16 – 40 – 16 VDC	—	—	400	—	—	400	—	—	500	—	—	500	mV pk
	TRANSIENT <sup>1, 4</sup>	—	—	400	—	—	400	—	—	500	—	—	500	μs
	RECOVERY <sup>1, 3</sup>	—	—	300	—	—	300	—	—	300	—	—	300	
START-UP <sup>5</sup>	DELAY	—	—	10	—	—	10	—	—	10	—	—	10	ms
	OVERSHOOT <sup>1</sup>	—	0	25	—	0	50	—	0	50	—	0	50	mV pk
INHIBIT PIN CURRENT <sup>1</sup>	UNIT INHIBITED	—	0.1	1.0	—	0.1	1.0	—	0.1	1.0	—	0.1	1.0	mA
CAPACITIVE LOAD <sup>1</sup>	NO EFFECT ON DC PERFORMANCE	—	—	1000	—	—	1000	—	—	1000	—	—	1000	μF

Notes:

1. Guaranteed by design, not tested.

2. Short circuit is measured with a 10 mΩ (±10%) resistive load.

3. Time to settle to within 1% of V<sub>out</sub>.

4. Transition time > 10 μs

5. Tested on release from inhibit.

# MOR Single and Dual DC/DC Converters

## 28 VOLT INPUT – 120 WATT

Electrical Characteristics: 25°C Tc, 28 VDC Vin, 100% load, free run, unless otherwise specified.

SINGLE AND DUAL OUTPUT MODELS		MOR2812S			MOR2815S			MOR283R3D			MOR2805D			UNITS
PARAMETER	CONDITIONS	MIN	TYP	MAX	MIN	TYP	MAX	MIN	TYP	MAX	MIN	TYP	MAX	
OUTPUT VOLTAGE <sup>5</sup>	+V <sub>OUT</sub>	11.88	12.00	12.12	14.85	15.00	15.15	3.25	3.30	3.35	4.95	5.00	5.05	VDC
	-V <sub>OUT</sub>	—	—	—	—	—	—	3.22	3.30	3.38	4.92	5.00	5.08	
OUTPUT CURRENT	V <sub>IN</sub> = 16 to 40 VDC	0	—	9.2	0	—	8	—	±10	20 <sup>6</sup>	—	±10	20 <sup>6</sup>	A
OUTPUT POWER	V <sub>IN</sub> = 16 to 40 VDC	—	—	110	—	—	120	—	—	66 <sup>6</sup>	—	—	100 <sup>6</sup>	W
OUTPUT RIPPLE VOLTAGE +V <sub>OUT</sub> , ±V <sub>OUT</sub>	10 kHz - 20 MHz Tc = -55°C to +125°C	—	75	120	—	75	150	—	50	80	—	50	80	mV p-p
	10 kHz - 2 MHz Tc = -55°C to +125°C	—	50	100	—	50	120	—	35	50	—	35	50	
LINE REGULATION V <sub>IN</sub> = 16 to 40 VDC	+V <sub>OUT</sub>	—	0	20	—	0	20	—	25	50	—	25	50	mV
	-V <sub>OUT</sub>	—	—	—	—	—	—	—	50	100	—	50	100	
LOAD REGULATION	+V <sub>OUT</sub>	—	0	30	—	0	30	—	25	50	—	25	50	mV
	-V <sub>OUT</sub>	—	—	—	—	—	—	—	50	150	—	50	150	
CROSS REGULATION <sup>7</sup>	NEGATIVE V <sub>OUT</sub>	—	—	—	—	—	—	—	6	10	—	5	8	%
INPUT VOLTAGE	CONTINUOUS	16	28	40	16	28	40	16	28	40	16	28	40	VDC
	TRANSIENT 120 msec <sup>1</sup>	—	—	50	—	—	50	—	—	50	—	—	50	V
INPUT CURRENT	NO LOAD	—	70	130	—	70	130	—	70	140	—	70	140	mA
	INHIBITED - INH1	—	—	10	—	—	10	—	—	10	—	—	10	mA
	INHIBITED - INH2	—	—	70	—	—	70	—	—	70	—	—	70	mA
INPUT RIPPLE CURRENT	10 kHz - 20 MHz Tc = -55°C to +125°C	—	50	130	—	50	130	—	60	90	—	60	130	mA p-p
EFFICIENCY		84	86	—	84	87	—	76	77	—	78	81	—	%
LOAD FAULT	POWER DISSIPATION OVERLOAD	—	30	—	—	30	—	—	27	—	—	30	—	W
	SHORT CIRCUIT <sup>2</sup>	—	—	22	—	—	20	—	—	22	—	—	27	ms
	RECOVERY <sup>1</sup>	—	—	10	—	—	10	—	—	10	—	—	10	ms
STEP LOAD RESP. +V <sub>OUT</sub> , ±V <sub>OUT</sub>	50% – 100% – 50% TRANSIENT	—	—	600	—	—	600	—	—	250	—	—	250	mV pk
	RECOVERY <sup>3</sup>	—	—	300	—	—	300	—	—	200	—	—	200	μs
STEP LINE RESP. +V <sub>OUT</sub> , ±V <sub>OUT</sub>	16 – 40 – 16 VDC TRANSIENT <sup>1, 4</sup>	—	—	600	—	—	600	—	—	400	—	—	400	mV pk
	RECOVERY <sup>1, 3</sup>	—	—	300	—	—	300	—	—	300	—	—	300	μs
START-UP <sup>8</sup>	DELAY	—	—	10	—	—	10	—	—	10	—	—	10	ms
	OVERSHOOT <sup>1</sup>	—	—	50	—	—	50	—	—	25	—	—	50	mV pk
INHIBIT PIN CURRENT <sup>1</sup>	UNIT INHIBITED	—	0.1	1.0	—	0.1	1.0	—	0.1	1.0	—	0.1	1.0	mA
CAPACITIVE LOAD <sup>1</sup>	NO EFFECT ON DC PERFORMANCE	—	—	1000	—	—	1000	—	—	1000	—	—	1000	μF

Notes:

1. Guaranteed by design, not tested.
2. Short circuit is measured with a 10 mΩ (±10%) resistive load.
3. Time to settle to within 1% of Vout.
4. Transition time > 10 μs
5. Output voltage for dual output models is measured at half load.
6. The maximum specification is the total output current/power. Up to 70%

7. Effect on negative Vout from 50%/50% loads to 70%/30% or 30%/70% loads.
8. Tested on release from inhibit.



# MOR Single and Dual DC/DC Converters

## 28 VOLT INPUT – 120 WATT

Electrical Characteristics: 25°C Tc, 28 VDC Vin, 100% load, free run, unless otherwise specified.

DUAL OUTPUT MODELS		MOR286R3D			MOR289R5D			MOR2812D			MOR2815D			UNITS
PARAMETER	CONDITIONS	MIN	TYP	MAX	MIN	TYP	MAX	MIN	TYP	MAX	MIN	TYP	MAX	
OUTPUT VOLTAGE <sup>5</sup>	+V <sub>OUT</sub>	6.24	6.30	6.36	9.41	9.50	9.58	11.88	12.00	12.12	14.85	15.00	15.15	VDC
	-V <sub>OUT</sub>	6.22	6.30	6.38	9.36	9.50	9.63	11.82	12.00	12.18	14.77	15.00	15.23	
OUTPUT CURRENT <sup>6</sup>	V <sub>IN</sub> = 16 to 40 VDC	—	±8	16	—	±5.53	11.05	—	±4.58	9.16	—	±4.00	8.00	A <sup>6</sup>
OUTPUT POWER	V <sub>IN</sub> = 16 to 40 VDC	—	—	100	—	—	105	—	—	110	—	—	120	W
OUTPUT RIPPLE VOLTAGE +V <sub>OUT</sub> / -V <sub>OUT</sub>	10 kHz - 20 MHz Tc = -55°C to +125°C	—	50	100	—	75	120	—	75	120	—	75	150	mV p-p
	10 kHz - 2 MHz Tc = -55°C to +125°C	—	30	60	—	50	80	—	50	100	—	50	120	
LINE REGULATION V <sub>IN</sub> = 16 to 40 VDC	+V <sub>OUT</sub>	—	25	50	—	25	50	—	25	50	—	25	50	mV
	-V <sub>OUT</sub>	—	50	160	—	50	100	—	50	100	—	50	100	
LOAD REGULATION	+V <sub>OUT</sub>	—	25	50	—	25	50	—	25	50	—	25	50	mV
	-V <sub>OUT</sub>	—	50	200	—	50	200	—	50	200	—	50	200	
CROSS REGULATION <sup>7</sup>	NEGATIVE V <sub>OUT</sub>	—	5	8	—	4	7	—	3	5	—	2	4	%
INPUT VOLTAGE	CONTINUOUS	16	28	40	16	28	40	16	28	40	16	28	40	VDC
	TRANSIENT 120 msec <sup>1</sup>	—	—	50	—	—	50	—	—	50	—	—	50	V
INPUT CURRENT	NO LOAD	—	70	140	—	70	140	—	70	140	—	70	140	mA
	INHIBITED - INH1	—	—	10	—	—	10	—	—	10	—	—	10	mA
	INHIBITED - INH2	—	—	70	—	—	60	—	—	70	—	—	70	
INPUT RIPPLE CURRENT	10 kHz - 20 MHz Tc = -55°C to +125°C	—	—	130	—	—	130	—	—	130	—	—	130	mA p-p
EFFICIENCY		81	83	—	82	84	—	84	86	—	85	87	—	%
LOAD FAULT	POWER DISSIPATION OVERLOAD	—	30	—	—	30	—	—	30	—	—	30	—	W
	SHORT CIRCUIT <sup>2</sup>	—	—	24	—	—	24	—	—	24	—	—	20	
	RECOVERY <sup>1</sup>	—	—	10	—	—	10	—	—	10	—	—	10	ms
STEP LOAD RESP. ± V <sub>OUT</sub>	50% – 100% – 50% TRANSIENT	—	—	500	—	—	500	—	—	600	—	—	600	mV pk
	RECOVERY <sup>3</sup>	—	—	300	—	—	300	—	—	300	—	—	300	μs
STEP LINE RESP. ± V <sub>OUT</sub>	16 – 40 – 16 VDC TRANSIENT <sup>1, 4</sup>	—	—	500	—	—	600	—	—	600	—	—	750	mV pk
	RECOVERY <sup>1, 3</sup>	—	—	300	—	—	300	—	—	300	—	—	300	
START-UP <sup>8</sup>	DELAY	—	—	10	—	—	10	—	—	10	—	—	10	ms
	OVERSHOOT <sup>1</sup>	—	—	50	—	—	50	—	—	50	—	—	50	mV pk
INHIBIT PIN CURRENT <sup>1</sup>	UNIT INHIBITED	—	0.1	1.0	—	0.1	1.0	—	0.1	1.0	—	0.1	1.0	mA
CAPACITIVE LOAD <sup>1</sup>	NO EFFECT ON DC PERFORMANCE	—	—	1000	—	—	1000	—	—	1000	—	—	1000	μF

Notes:

1. Guaranteed by design, not tested.

2. Short circuit is measured with a 10 mΩ (±10%) resistive load.

3. Time to settle to within 1% of Vout.

4. Transition time > 10 μs

5. Output voltage for dual output models is measured at half load.

6. The maximum specification is the total output current/power. Up to 70%

of that total is available from either output provided the other output maintains a minimum of 15% the total power used.

7. Effect on negative Vout from 50%/50% loads to 70%/30% or 30%/70% loads.

8. Tested on release from inhibit.

# MOR Single and Dual DC/DC Converters

## 28 VOLT INPUT – 120 WATT

Typical Performance Curves: 25°C Tc, 28 VDC Vin, 100% load, 20 MHz BW, free run, unless otherwise specified.

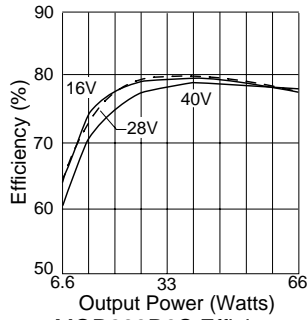

MOR283R3S Efficiency  
**FIGURE 14**

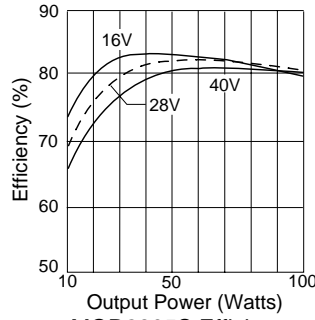

MOR2805S Efficiency  
**FIGURE 15**

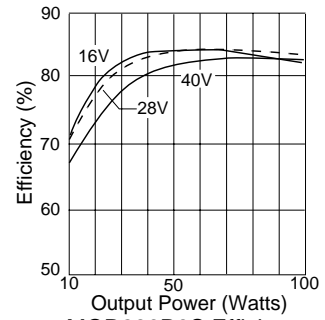

MOR286R3S Efficiency  
**FIGURE 16**

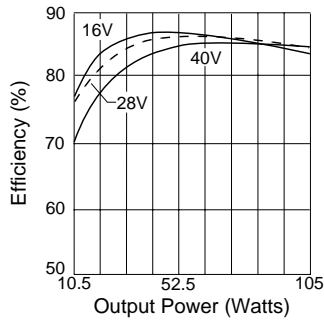

**FIGURE 17**

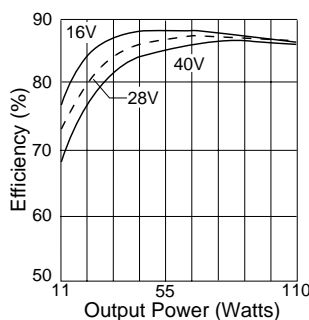

**FIGURE 18**

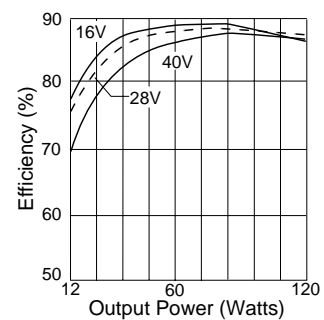

**FIGURE 19**

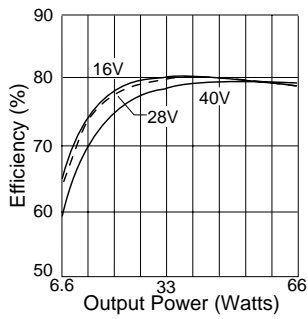

MOR283R3D Efficiency  
**FIGURE 20**

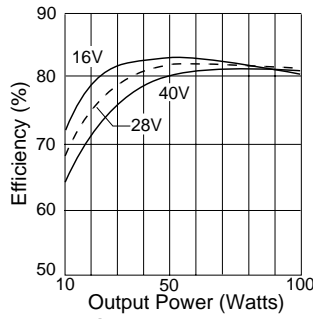

**FIGURE 21**

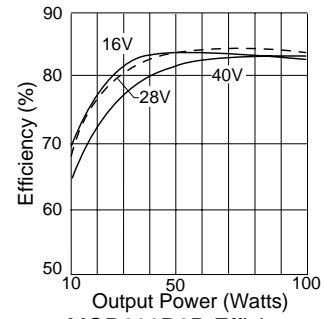

**FIGURE 22**

# MOR Single and Dual DC/DC Converters

## 28 VOLT INPUT – 120 WATT

Typical Performance Curves: 25°C Tc, 28 VDC Vin, 100% load, 20 MHz BW, free run, unless otherwise specified.

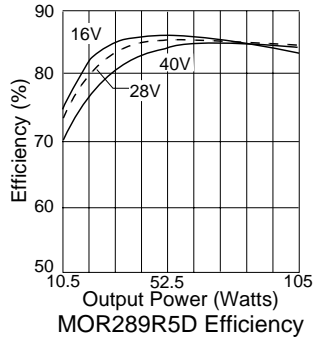

FIGURE 23

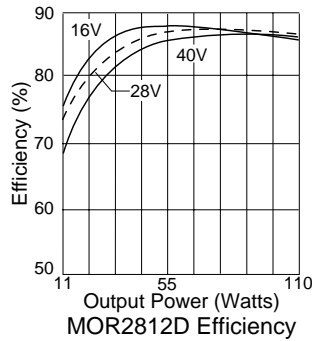

FIGURE 24

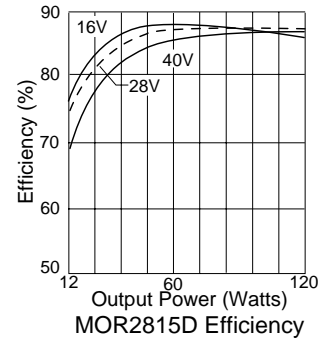

FIGURE 25

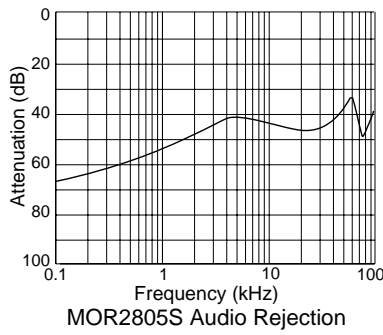

FIGURE 26

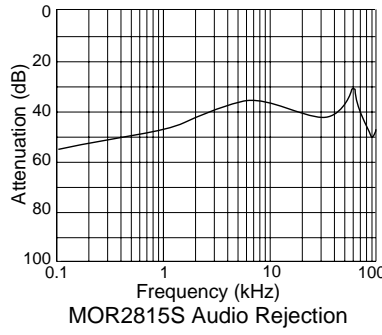

FIGURE 27

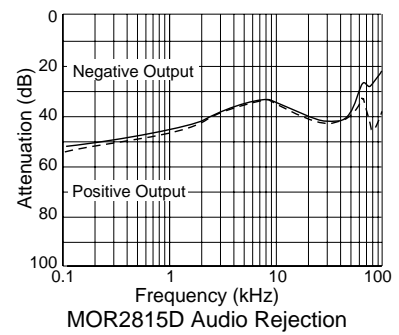
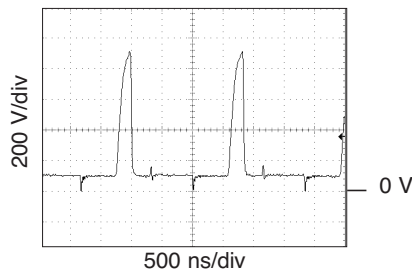
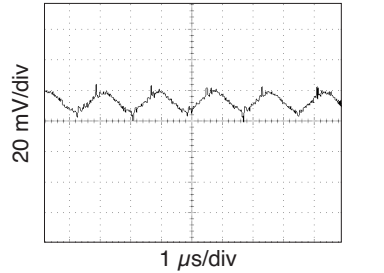

FIGURE 28



Representative of all models  
MOR2812D Sync Out

FIGURE 29



MOR2805S Output Ripple (Vout)

FIGURE 30

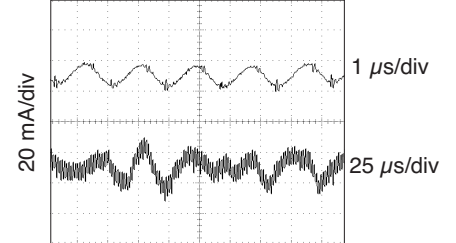

MOR2805S Input Ripple Current (Iin)

FIGURE 31

# MOR Single and Dual DC/DC Converters

## 28 VOLT INPUT – 120 WATT

Typical Performance Curves: 25°C Tc, 28 VDC Vin, 100% load, 20 MHz BW, free run, unless otherwise specified.

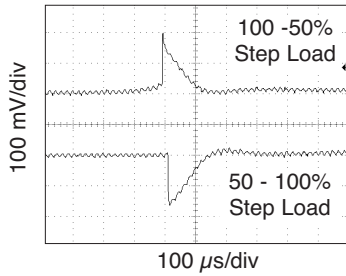

MOR2805S Step Load Response  
**FIGURE 32**

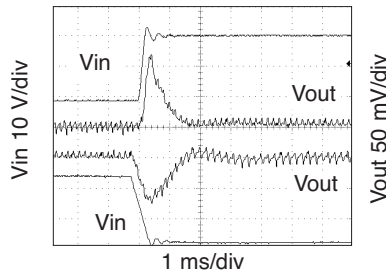

18 to 40 V, 40 to 18 V  
MOR2805S Step Line Response  
**FIGURE 33**

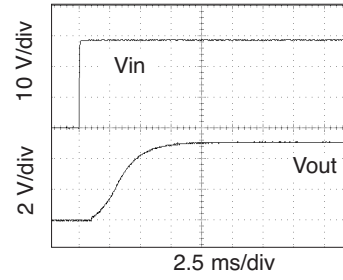

All combinations of line and load  
MOR2805S Turn On Response  
**FIGURE 34**

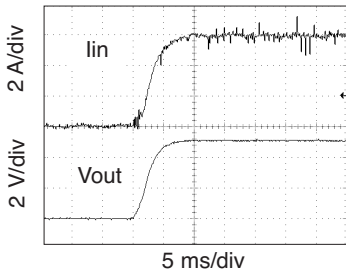

With and without 470 μF cap. load  
MOR2805S Inhibit Release Inrush Current  
**FIGURE 35**

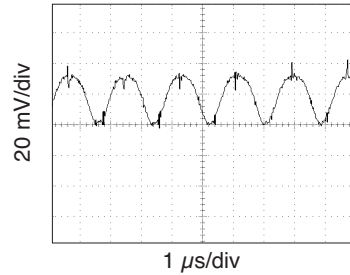

MOR2815S Output Ripple (Vout)  
**FIGURE 36**

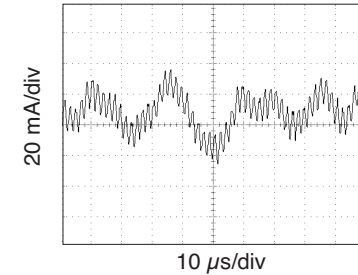

MOR2815S Input Ripple (lin)  
**FIGURE 37**

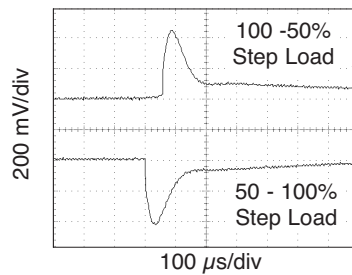

MOR2815S Step Load Response  
**FIGURE 38**

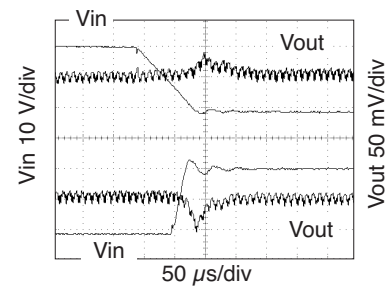

18 to 40 V, 40 to 18 V, 50% load  
MOR2815S Step Line Response  
**FIGURE 39**

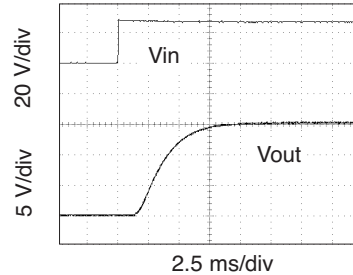

All combinations of line and load  
MOR2815S Turn On Response  
**FIGURE 40**

# MOR Single and Dual DC/DC Converters

## 28 VOLT INPUT – 120 WATT

Typical Performance Curves: 25°C Tc, 28 VDC Vin, 100% load, 20 MHz BW, free run, unless otherwise specified.

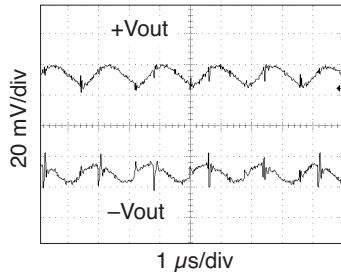

80% load each output  
MOR2805D Output Ripple ( $\pm V_{out}$ )  
**FIGURE 41**

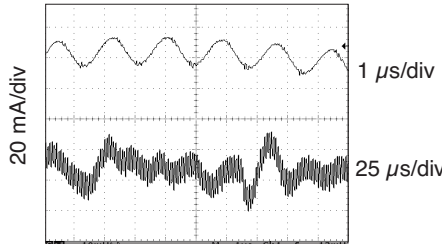

80% load each output  
MOR2805D Input Ripple ( $I_{in}$ )  
**FIGURE 42**

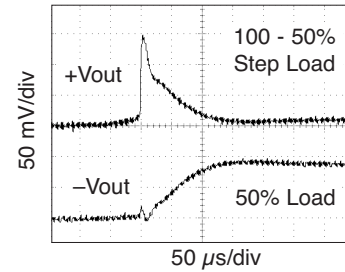

MOR2805D Step Load Response  
**FIGURE 43**

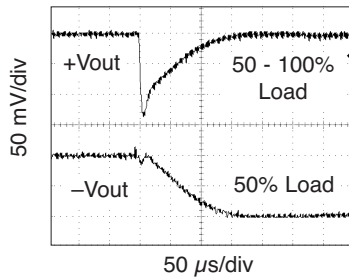

MOR2805D Step Load Response  
**FIGURE 44**

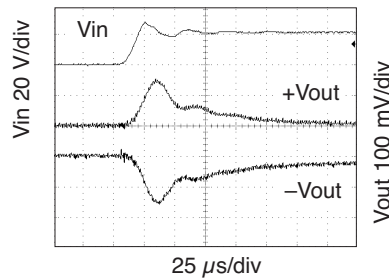

18 to 40 V, 80% load each output  
MOR2805D Step Line Response  
**FIGURE 45**

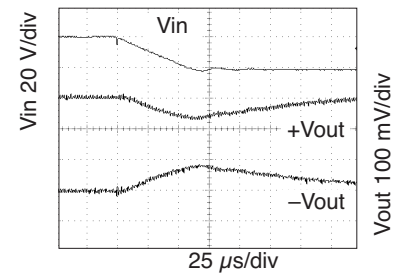

40 to 18 V, 80% load each output  
MOR2805D Step Line Response  
**FIGURE 46**

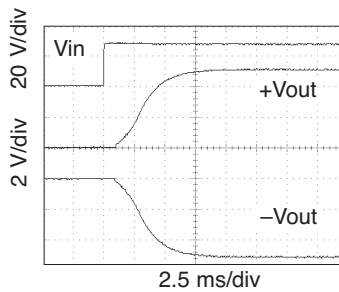

80% load each output  
MOR2805D Turn On Response  
**FIGURE 47**

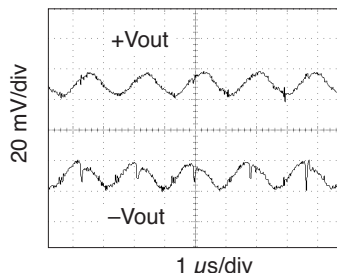

MOR2812D Output Ripple ( $\pm V_{out}$ )  
**FIGURE 48**

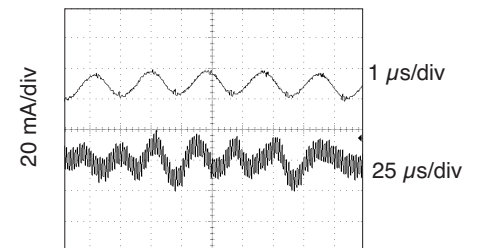

MOR2812D Input Ripple ( $I_{in}$ )  
**FIGURE 49**

# MOR Single and Dual DC/DC Converters

## 28 VOLT INPUT – 120 WATT

Typical Performance Curves: 25°C Tc, 28 VDC Vin, 100% load, 20 MHz BW, free run, unless otherwise specified.

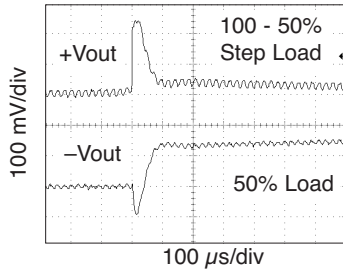

MOR2812D Step Load Response  
**FIGURE 50**

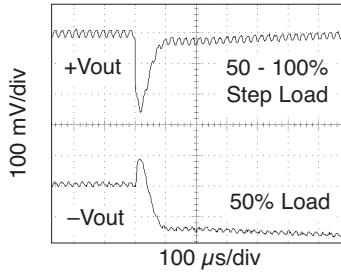

MOR2812D Step Load Response  
**FIGURE 51**

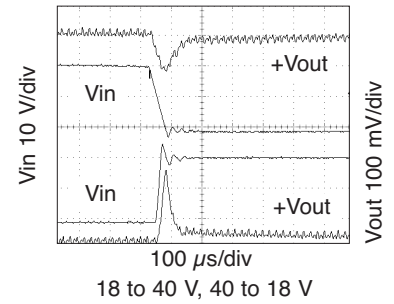

MOR2812D Step Line Response  
**FIGURE 52**

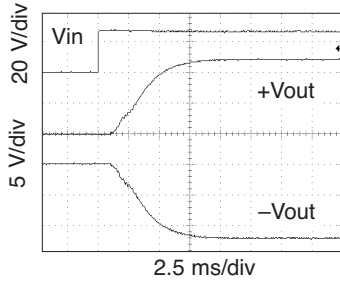

MOR2812D Turn On Response  
**FIGURE 53**

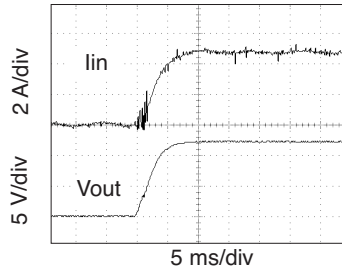

MOR2812D Inhibit Release Inrush Current  
**FIGURE 54**

# MOR Single and Dual DC/DC Converter Cases

## 28 VOLT INPUT – 120 WATT

### TOP VIEW CASE U Flanged case, short-leaded

\*Does not require designator in Case Option position of model number.

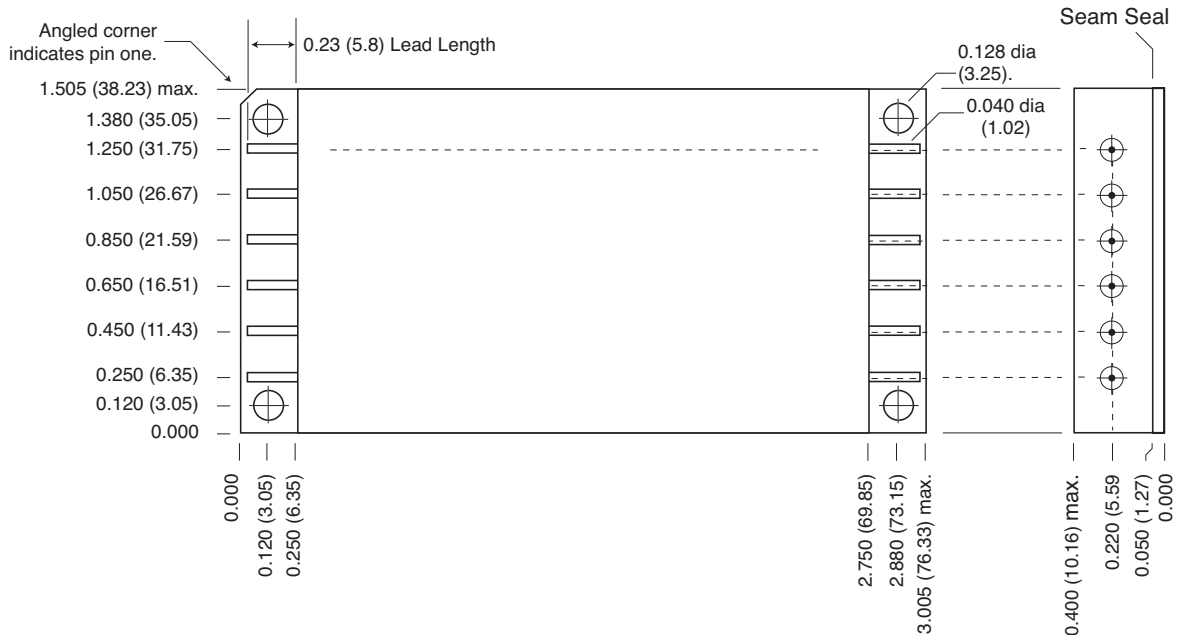

Seal hole: 0.100 ±0.002 (2.54 ±0.05)

**Case dimensions in inches (mm)**

Tolerance ±0.005 (0.13) for three decimal places  
 ±0.01 (0.3) for two decimal places  
 unless otherwise specified

**CAUTION**

Heat from reflow or wave soldering may damage the device.  
 Solder pins individually with heat application not exceeding 300°C for 10 seconds per pin

**Materials**

Header Cold Rolled Steel/Nickel/Gold  
 Cover Kovar/Nickel  
 Pins #52 alloy/Gold; compression glass seal

Case U, Rev C, 20060302  
 Please refer to the numerical dimensions for accuracy. All information is believed to be accurate, but no responsibility is assumed for errors or omissions. Interpoint reserves the right to make changes in products or specifications without notice.  
 Copyright © 1999-2006 Interpoint Corp. All rights reserved.

**FIGURE 55: CASE U**

# MOR Single and Dual DC/DC Converter Cases

## 28 VOLT INPUT – 120 WATT

### TOP VIEW CASE V\* Flanged case, down leaded

\*Designator "V" required in Case Option position of model number.

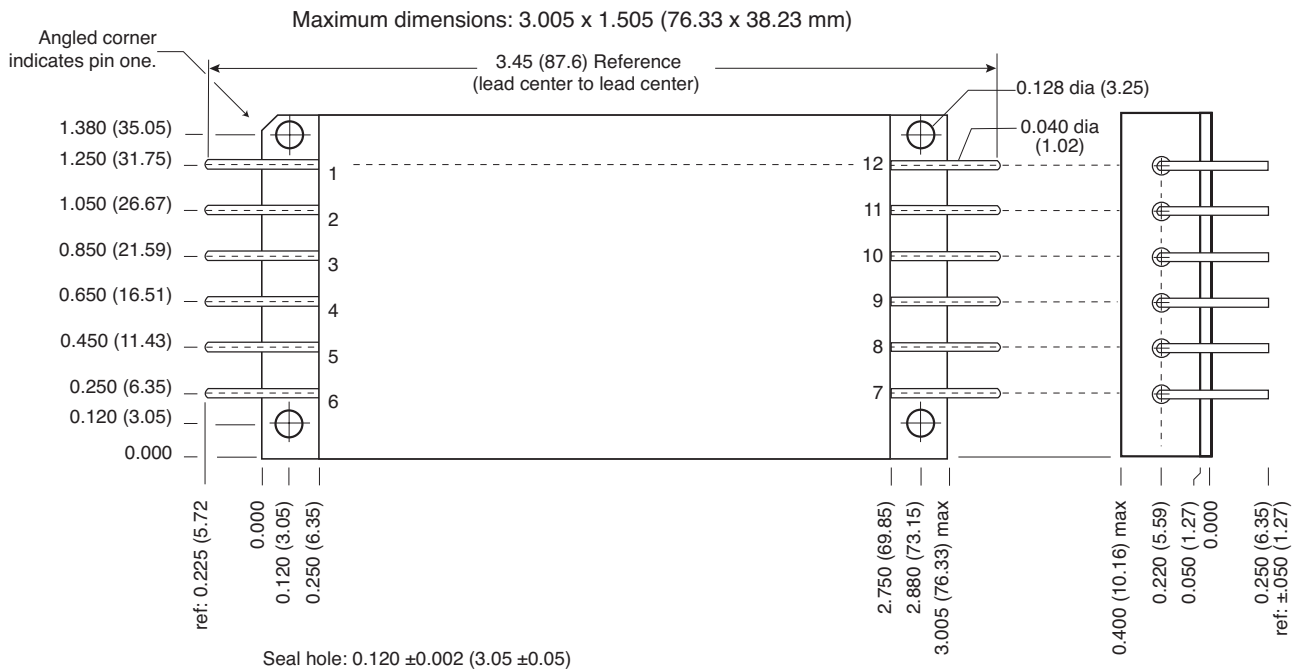

#### Case dimensions in inches (mm)

Tolerance ±0.005 (0.13) for three decimal places  
±0.01 (0.2) for two decimal places  
unless otherwise specified

#### CAUTION

Heat from reflow or wave soldering may damage the device.  
Solder pins individually with heat application not exceeding 300°C for 10 seconds per pin.

#### Materials

Header Cold Rolled Steel/Nickel/Gold  
Cover Kovar/Nickel  
Pins #52 alloy/Gold compression glass seal

Case V, Rev C, 20060106

Please refer to the numerical dimensions for accuracy. All information is believed to be accurate, but no responsibility is assumed for errors or omissions. Interpoint reserves the right to make changes in products or specifications without notice.

Copyright © 1999-2006 Interpoint Corp. All rights reserved.

FIGURE 56: CASE V



# MOR Single and Dual DC/DC Converter Cases

## 28 VOLT INPUT – 120 WATT

### TOP VIEW CASE W\*

Tabbed case, up-ledged

\*Designator "W" required in Case Option position of model number.

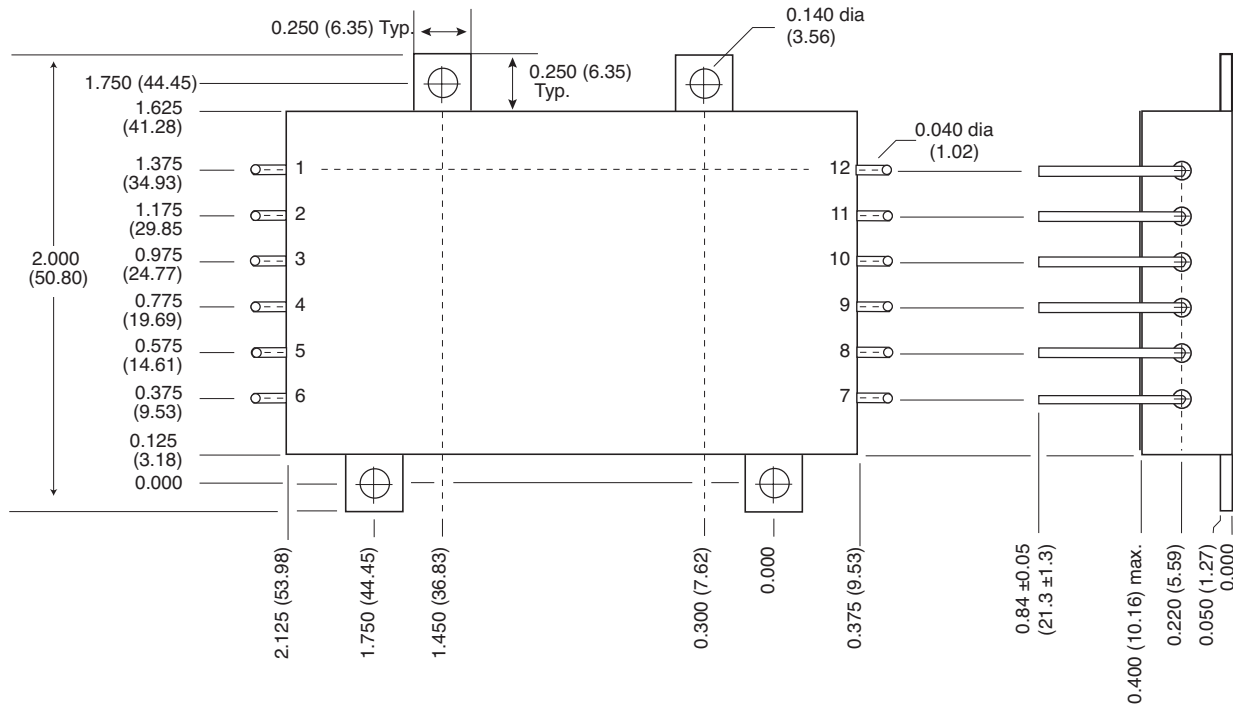

Seal hole: 0.120 ±0.002 (3.05 ±0.05)

**Case dimensions in inches (mm)**

Tolerance ±0.005 (0.13) for three decimal places  
 ±0.01 (0.2) for two decimal places  
 unless otherwise specified

**CAUTION**

Heat from reflow or wave soldering may damage the device.  
 Solder pins individually with heat application not exceeding 300°C for 10 seconds per pin.

**Materials**

- Header Cold Rolled Steel/Nickel/Gold
- Cover Kovar/Nickel
- Pins #52 alloy/Gold compression glass seal

Case W, Rev C, 20060106  
 Please refer to the numerical dimensions for accuracy. All information is believed to be accurate, but no responsibility is assumed for errors or omissions. Interpoint reserves the right to make changes in products or specifications without notice.  
 Copyright © 1999-2006 Interpoint Corp. All rights reserved.

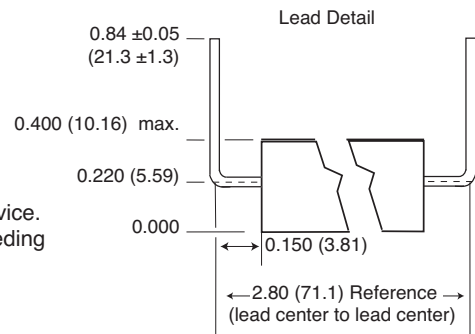

**FIGURE 57: CASE W**

# MOR Single and Dual DC/DC Converter Cases

## 28 VOLT INPUT – 120 WATT

### TOP VIEW CASE Y\* Tabbed case, straight-leaded

\*Designator "Y" required in Case Option position of model number.

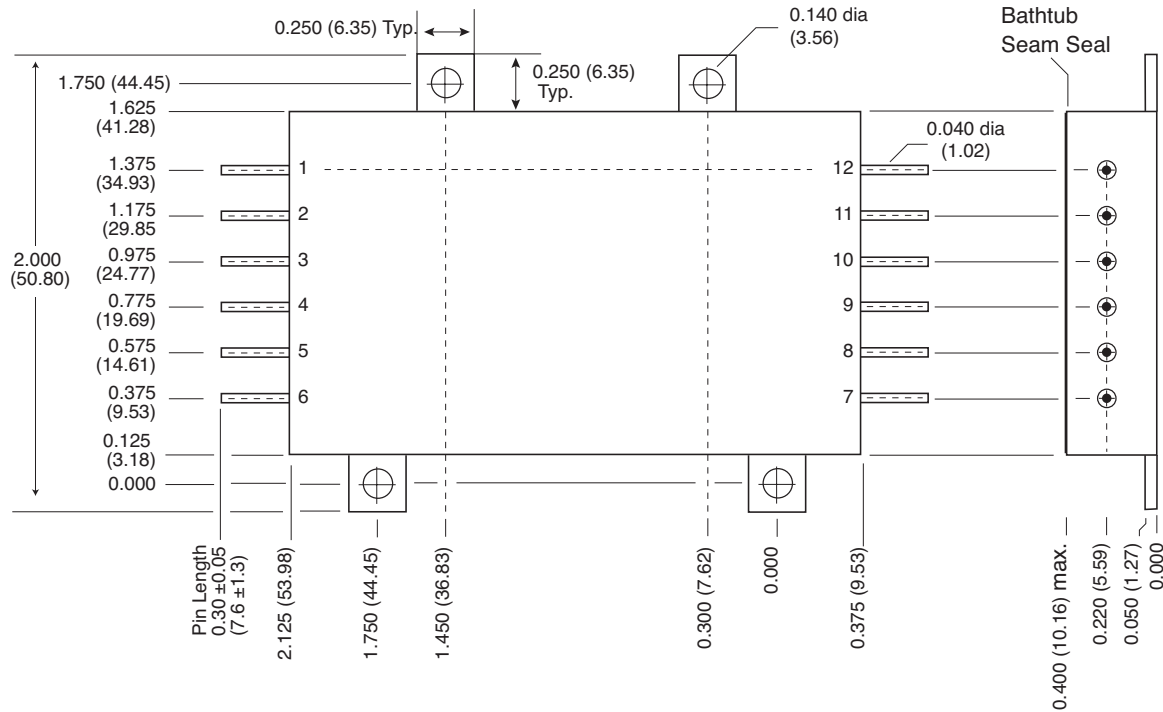

Seal hole: 0.120 ±0.002 (3.05 ±0.05)

**Case dimensions in inches (mm)**

Tolerance ±0.005 (0.13) for three decimal places  
±0.01 (0.2) for two decimal places  
unless otherwise specified

**CAUTION**

Heat from reflow or wave soldering may damage the device.  
Solder pins individually with heat application not exceeding 300°C for 10 seconds per pin.

**Materials**

- Header Cold Rolled Steel/Nickel/Gold
- Cover Kovar/Nickel
- Pins #52 alloy/Gold compression glass seal

Case Y, Rev C, 20060106  
Please refer to the numerical dimensions for accuracy. All information is believed to be accurate, but no responsibility is assumed for errors or omissions. Interpoint reserves the right to make changes in products or specifications without notice.  
Copyright © 1999-2006 Interpoint Corp. All rights reserved.

**Lead Detail**

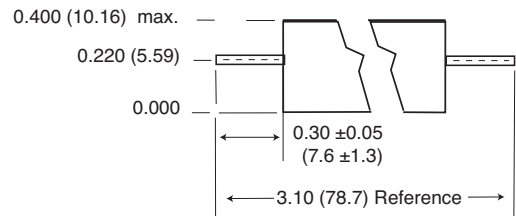

**FIGURE 58: CASE Y**



# MOR Single and Dual DC/DC Converters

28 VOLT INPUT – 120 WATT

## 883, CLASS H, QML PRODUCTS – ELEMENT EVALUATION

ELEMENT EVALUATION  TEST PERFORMED (COMPONENT LEVEL)	STANDARD (NON-QML) <sup>1</sup>		CLASS H, QML	
	M/S <sup>2</sup>	P <sup>3</sup>	M/S <sup>2</sup>	P <sup>3</sup>
Element Electrical (probe)	yes	no	yes	yes
Element Visual	no	no	yes	yes
Internal Visual	no	no	yes	no
Final Electrical	no	no	yes	yes
Wire Bond Evaluation <sup>4</sup>	no	no	yes	yes
SLAM™/C-SAM: Input Capacitors only (Add'l test, not req. by H or K)	no	no	no	yes

**Definitions:**

Element Evaluation: Component testing/screening per MIL-STD-883 as determined by MIL-PRF-38534

SLAM™: Scanning Laser Acoustic Microscopy

C-SAM: C - Mode Scanning Acoustic Microscopy

**Notes:**

1. Non-QML products do not meet all of the requirements of MIL-PRF-38534
2. M/S = Active components (Microcircuit and Semiconductor Die)
3. P = Passive components
4. Not applicable to EMI filters that have no wire bonds

# MOR Single and Dual DC/DC Converters

## 28 VOLT INPUT – 120 WATT

### 883, CLASS H, QML PRODUCTS – ENVIRONMENTAL SCREENING

TEST	125°C STANDARD non-QML <sup>1</sup>	125°C /ES non-QML <sup>1</sup>	Class H /883 QML
Pre-cap Inspection Method 2017, 2032	yes	yes	yes
Temperature Cycle (10 times) Method 1010, Cond. C, -65°C to 150°C, ambient Method 1010, Cond. B, -55°C to 125°C, ambient	no no	no yes	yes no
Constant Acceleration Method 2001, 3000 g Method 2001, 500g	no no	no yes	yes no
Burn-In Method 1015, 160 hours at 125°C case, typical 96 hours at 125°C case, typical	no no	no yes	yes no
Final Electrical Test MIL-PRF-38534, Group A Subgroups 1 through 6: -55°C, +25°C, +125°C case Subgroups 1 and 4: +25°C case	no yes	no yes	yes no
Hermeticity Test Fine Leak, Method 1014, Cond. A Gross Leak, Method 1014, Cond. C Gross Leak, Dip (1 x 10 <sup>-3</sup> )	no no yes	yes yes no	yes yes no
Final Visual Inspection Method 2009	yes	yes	yes

Test methods are referenced to MIL-STD-883 as determined by MIL-PRF-38534.

#### Notes:

1. Non-QML products do not meet all of the requirements of MIL-PRF-38534