

QRE113GR

SMT Reflective Object Sensor

Features

- Phototransistor output
- Tape and reel packaging
- No contact surface sensing
- Miniature package
- Lead form style: Gull Wing

Package Dimensions

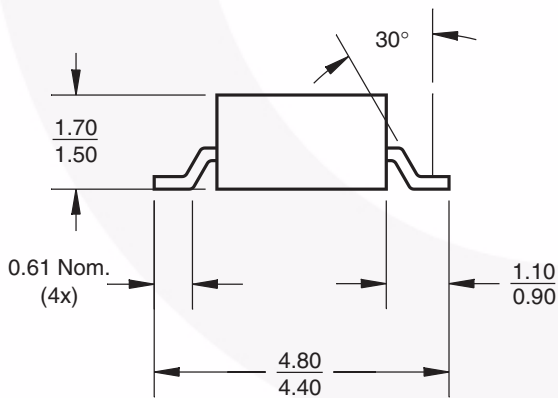
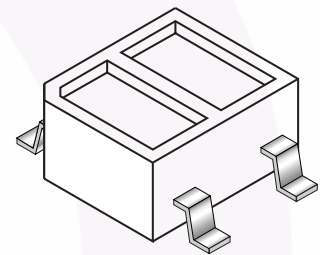
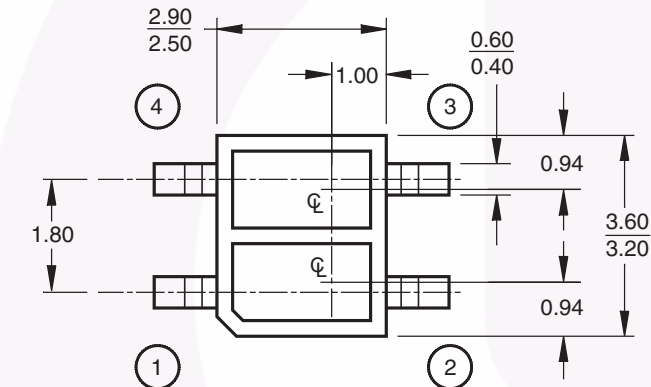

Schematic

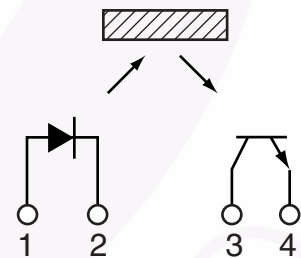

PIN 1 ANODE PIN 3 COLLECTOR
PIN 2 CATHODE PIN 4 EMITTER

Notes:

1. Dimensions for all drawings are in millimeters.
2. Tolerance of ± 0.15 mm on all non-nominal dimensions

Absolute Maximum Ratings ($T_A = 25^\circ\text{C}$ unless otherwise specified)

Stresses exceeding the absolute maximum ratings may damage the device. The device may not function or be operable above the recommended operating conditions and stressing the parts to these levels is not recommended. In addition, extended exposure to stresses above the recommended operating conditions may affect device reliability. The absolute maximum ratings are stress ratings only.

Symbol	Parameter	Rating	Units
T_{OPR}	Operating Temperature	-40 to +85	$^\circ\text{C}$
T_{STG}	Storage Temperature	-40 to +90	$^\circ\text{C}$
T_{SOL-I}	Soldering Temperature (Iron) ^(2,3,4)	240 for 5 sec	$^\circ\text{C}$
T_{SOL-F}	Soldering Temperature (Flow) ^(2,3)	260 for 10 sec	$^\circ\text{C}$
EMITTER			
I_F	Continuous Forward Current	50	mA
V_R	Reverse Voltage	5	V
I_{FP}	Peak Forward Current ⁽⁵⁾	1	A
P_D	Power Dissipation ⁽¹⁾	75	mW
SENSOR			
V_{CEO}	Collector-Emitter Voltage	30	V
V_{ECO}	Emitter-Collector Voltage	5	V
I_C	Collector Current	20	mA
P_D	Power Dissipation ⁽¹⁾	50	mW

Electrical/Optical Characteristics ($T_A = 25^\circ\text{C}$ unless otherwise specified)

Symbol	Parameter	Test Conditions	Min.	Typ.	Max.	Units
INPUT DIODE						
V_F	Forward Voltage	$I_F = 20\text{mA}$		1.2	1.6	V
I_R	Reverse Leakage Current	$V_R = 5\text{V}$			10	μA
λ_{PE}	Peak Emission Wavelength	$I_F = 20\text{mA}$		940		nm
OUTPUT TRANSISTOR						
I_D	Collector-Emitter Dark Current	$V_{CE} = 20\text{V}, I_F = 0\text{mA}$			100	nA
COUPLED						
$I_{C(ON)}$	On-State Collector Current	$I_F = 20\text{mA}, V_{CE} = 5\text{V}^{(6)}$	0.10	0.40		mA
$V_{CE(SAT)}$	Saturation Voltage				0.3	V
t_r	Rise Time	$V_{CC} = 5\text{V}, I_{C(ON)} = 100\mu\text{A}, R_L = 1\text{k}\Omega$		20		μs
t_f	Fall Time			20		

Notes:

- Derate power dissipation linearly 1.00mW/ $^\circ\text{C}$ above 25 $^\circ\text{C}$.
- RMA flux is recommended.
- Methanol or isopropyl alcohols are recommended as cleaning agents.
- Soldering iron 1/16" (1.6mm) from housing.
- Pulse conditions: $t_p = 100\mu\text{s}; T = 10\text{ms}$.
- Measured using an aluminum alloy mirror at $d = 1\text{mm}$.

Typical Performance Curves

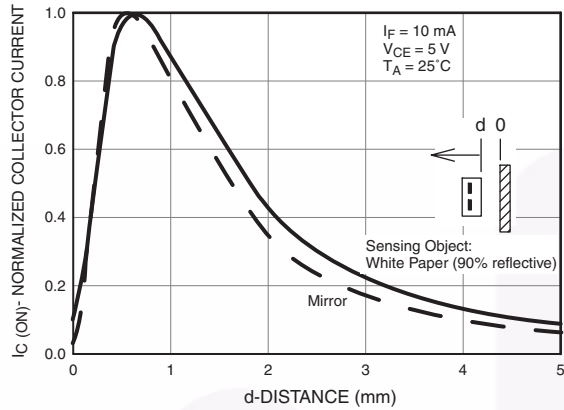

Fig. 1 Normalized Collector Current vs. Distance between device and reflector

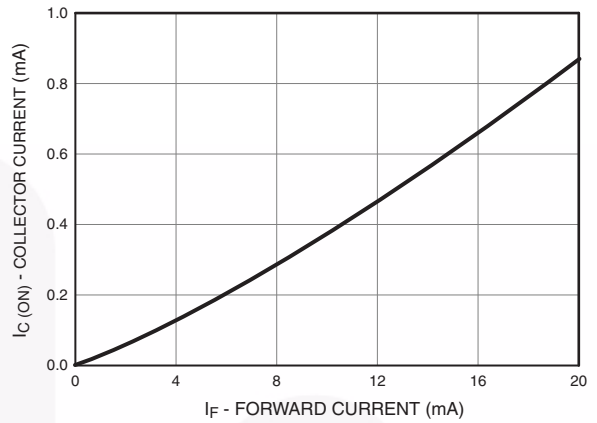

Fig. 2 Collector Current vs. Forward Current

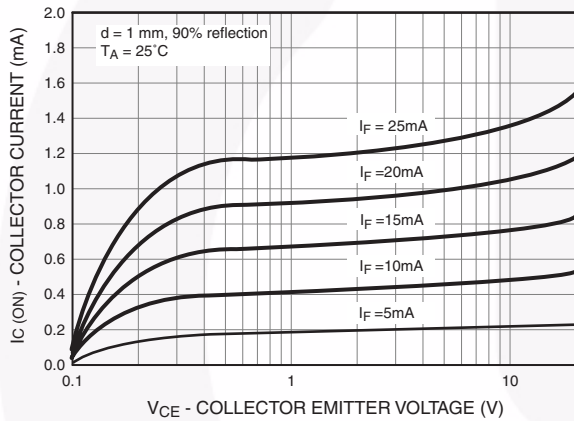

Fig. 3 Collector Current vs. Collector to Emitter Voltage

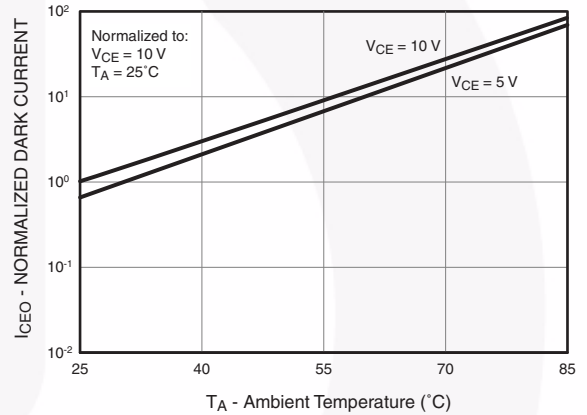

Fig. 4 Collector Emitter Dark Current (Normalized) vs. Ambient Temperature

Typical Performance Curves (Continued)

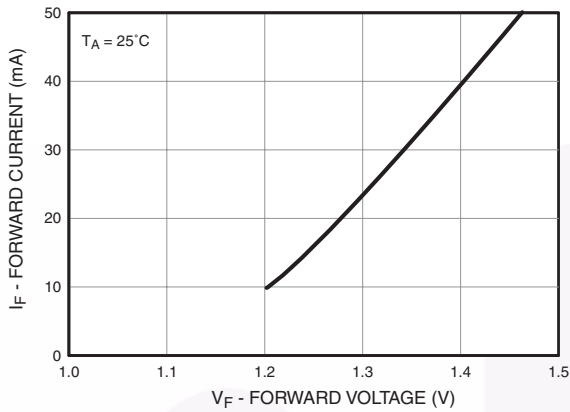

Fig. 6 Forward Current vs. Forward Voltage

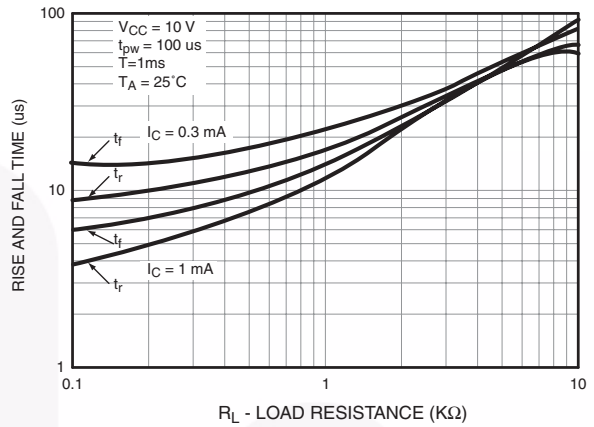

Fig. 7 Rise and Fall Time vs. Load Resistance

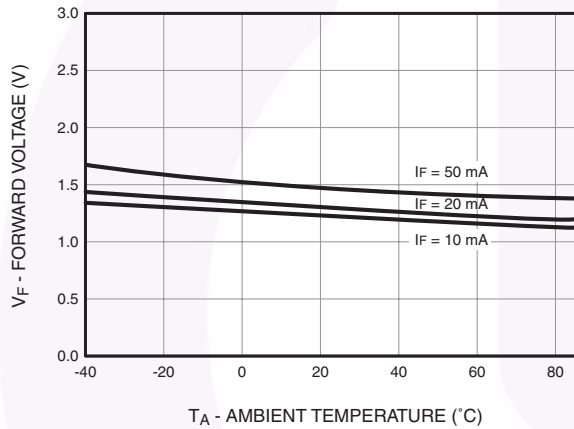

Fig. 8 Forward Voltage vs. Ambient Temperature

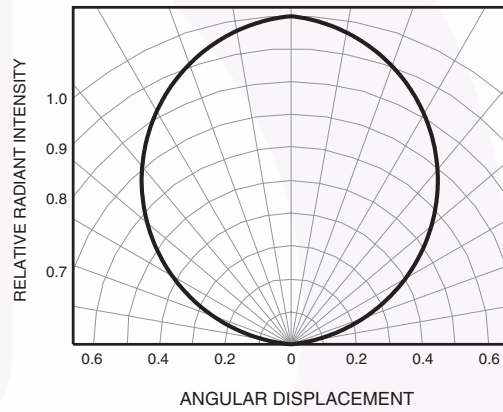
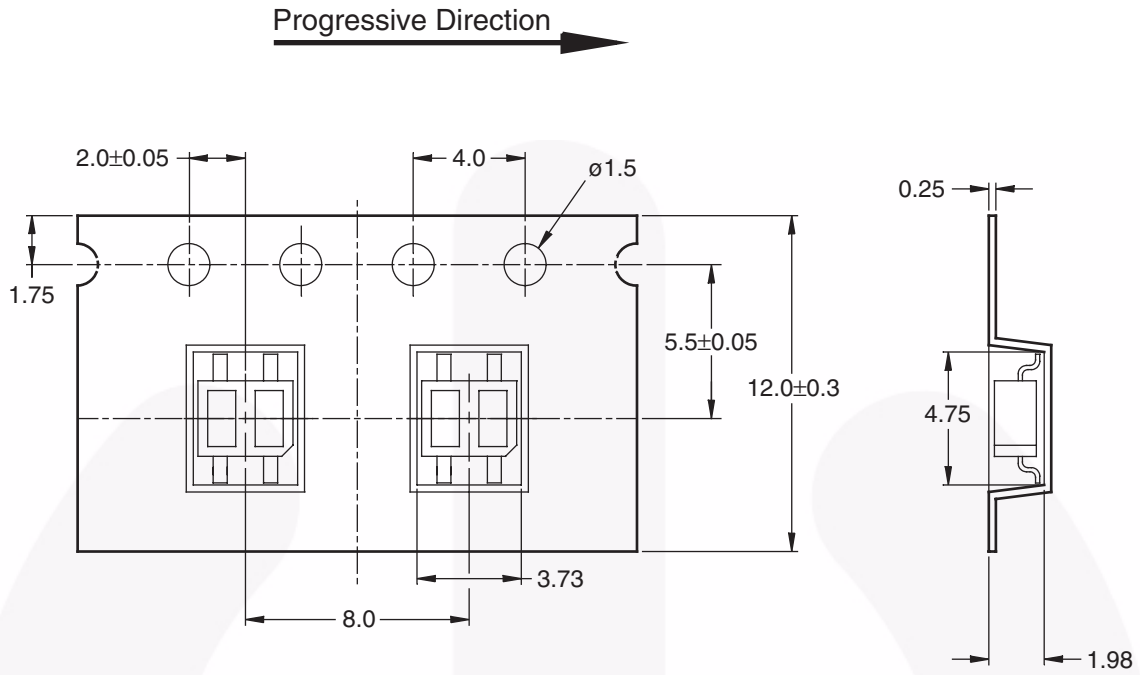

Fig. 8 Radiation Diagram

Taping Dimensions





General tolerance ± 0.1
Dimensions in mm



TRADEMARKS

The following includes registered and unregistered trademarks and service marks, owned by Fairchild Semiconductor and/or its global subsidiaries, and is not intended to be an exhaustive list of all such trademarks.

- | | | | |
|---|--|--|----------------------------------|
| ACEx [®] | FPS [™] | PDP-SPM [™] | SupreMOS [™] |
| Build it Now [™] | FRFET [®] | Power220 [®] | SyncFET [™] |
| CorePLUS [™] | Global Power Resource SM | POWEREDGE [®] | SYSTEM [®] |
| CROSSVOLT [™] | Green FPS [™] | Power-SPM [™] | GENERAL [®] |
| CTL [™] | Green FPS [™] e-Series [™] | PowerTrench [®] | The Power Franchise [®] |
| Current Transfer Logic [™] | GTO [™] | Programmable Active Droop [™] | power [®] |
| EcoSPARK [®] | i-Lo [™] | QFET [®] | the franchise |
| EZSWITCH [™] * | IntelliMAX [™] | QS [™] | TinyBoost [™] |
|  ™ | ISOPLANAR [™] | QT Optoelectronics [™] | TinyBuck [™] |
|  ™ | MegaBuck [™] | Quiet Series [™] | TinyLogic [®] |
| Fairchild [®] | MICROCOUPLER [™] | RapidConfigure [™] | TINYOPTO [™] |
| Fairchild Semiconductor [®] | MicroFET [™] | SMART START [™] | TinyPower [™] |
| FACT Quiet Series [™] | MicroPak [™] | SPM [®] | TinyPWM [™] |
| FACT [®] | MillerDrive [™] | STEALTH [™] | TinyWire [™] |
| FAST [®] | Motion-SPM [™] | SuperFET [™] | SerDes [™] |
| FastvCore [™] | OPTOLOGIC [®] | SuperSOT [™] 3 | UHC [®] |
| FlashWriter [®] * | OPTOPLANAR [®] | SuperSOT [™] 6 | Ultra FRFET [™] |
| | | SuperSOT [™] 8 | UniFET [™] |
| | | | VCX [™] |

* EZSWITCH[™] and FlashWriter[®] are trademarks of System General Corporation, used under license by Fairchild Semiconductor.

DISCLAIMER

FAIRCHILD SEMICONDUCTOR RESERVES THE RIGHT TO MAKE CHANGES WITHOUT FURTHER NOTICE TO ANY PRODUCTS HEREIN TO IMPROVE RELIABILITY, FUNCTION, OR DESIGN. FAIRCHILD DOES NOT ASSUME ANY LIABILITY ARISING OUT OF THE APPLICATION OR USE OF ANY PRODUCT OR CIRCUIT DESCRIBED HEREIN; NEITHER DOES IT CONVEY ANY LICENSE UNDER ITS PATENT RIGHTS, NOR THE RIGHTS OF OTHERS. THESE SPECIFICATIONS DO NOT EXPAND THE TERMS OF FAIRCHILD'S WORLDWIDE TERMS AND CONDITIONS, SPECIFICALLY THE WARRANTY THEREIN, WHICH COVERS THESE PRODUCTS.

LIFE SUPPORT POLICY

FAIRCHILD'S PRODUCTS ARE NOT AUTHORIZED FOR USE AS CRITICAL COMPONENTS IN LIFE SUPPORT DEVICES OR SYSTEMS WITHOUT THE EXPRESS WRITTEN APPROVAL OF FAIRCHILD SEMICONDUCTOR CORPORATION.

As used herein:

- Life support devices or systems are devices or systems which, (a) are intended for surgical implant into the body or (b) support or sustain life, and (c) whose failure to perform when properly used in accordance with instructions for use provided in the labeling, can be reasonably expected to result in a significant injury of the user.
- A critical component in any component of a life support, device, or system whose failure to perform can be reasonably expected to cause the failure of the life support device or system, or to affect its safety or effectiveness.

PRODUCT STATUS DEFINITIONS

Definition of Terms

Datasheet Identification	Product Status	Definition
Advance Information	Formative or In Design	This datasheet contains the design specifications for product development. Specifications may change in any manner without notice.
Preliminary	First Production	This datasheet contains preliminary data; supplementary data will be published at a later date. Fairchild Semiconductor reserves the right to make changes at any time without notice to improve design.
No Identification Needed	Full Production	This datasheet contains final specifications. Fairchild Semiconductor reserves the right to make changes at any time without notice to improve the design.
Obsolete	Not In Production	This datasheet contains specifications on a product that has been discontinued by Fairchild Semiconductor. The datasheet is printed for reference information only.

Rev. I33