

Load Switch with Level-Shift

PRODUCT SUMMARY		
V_{DS2} (V)	$r_{DS(on)}$ (Ω)	I_D (A)
1.8 to 8	0.060 @ $V_{IN} = 4.5$ V	2.9
	0.100 @ $V_{IN} = 2.5$ V	2.2
	0.175 @ $V_{IN} = 1.8$ V	1.7



ESD Protected
3000 V
1.8-V Rated

FEATURES

- 60-m Ω Low $r_{DS(on)}$ TrenchFET[®]
- 1.8 to 8-V Input
- 1.5 to 8-V Logic Level Control
- Low Profile, Small Footprint TSOP-6 Package
- 3000-V ESD Protection On Input Switch, $V_{ON/OFF}$
- Adjustable Slew-Rate

DESCRIPTION

The Si3865BDV includes a p- and n-channel MOSFET in a single TSOP-6 package. The low on-resistance p-channel TrenchFET[®] is tailored for use as a load switch. The n-channel, with an external resistor, can be used as a

level-shift to drive the p-channel load-switch. The n-channel MOSFET has internal ESD protection and can be driven by logic signals as low as 1.5-V. The Si3865BDV operates on supply lines from 1.8 to 8-V, and can drive loads up to 2.9 A.

APPLICATION CIRCUITS

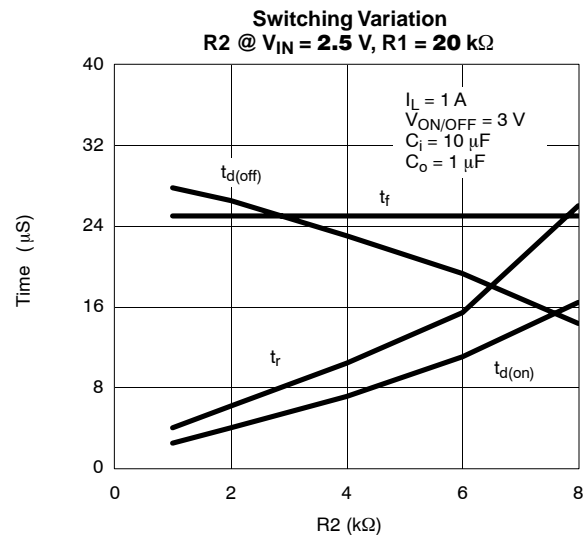
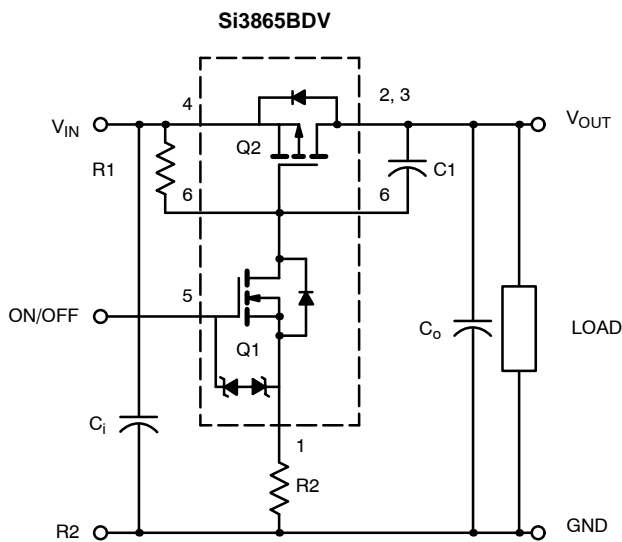

Note: For $R2$ switching variations with other $V_{IN}/R1$ combinations See Typical Characteristics

COMPONENTS

Component	Description	Typical Value
R1	Pull-Up Resistor	Typical 10 k Ω to 1 m Ω *
R2	Optional Slew-Rate Control	Typical 0 to 100 k Ω *
C1	Optional Slew-Rate Control	Typical 1000 pF

*Minimum R1 value should be at least 10 x R2 to ensure Q1 turn-on.

The Si3865BDV is ideally suited for high-side load switching in portable applications. The integrated n-channel level-shift device saves space by reducing external components. The slew rate is set externally so that rise-times can be tailored to different load types.

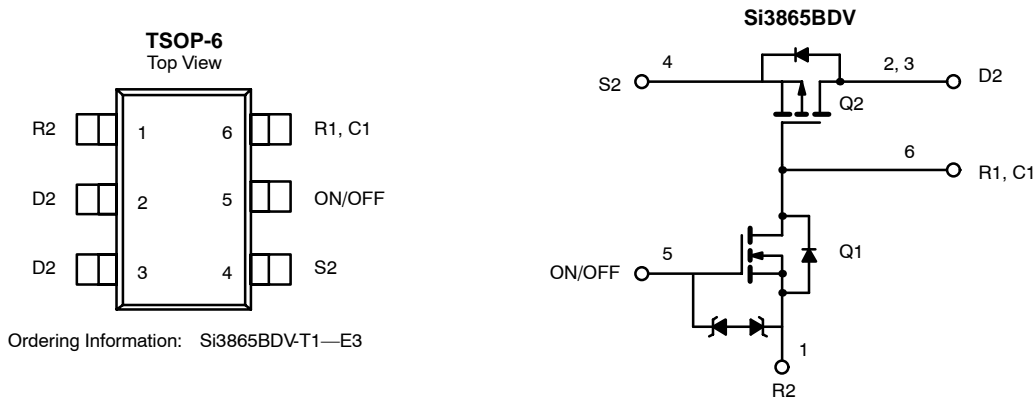
FUNCTIONAL BLOCK DIAGRAM

ABSOLUTE MAXIMUM RATINGS (T_A = 25 °C UNLESS OTHERWISE NOTED)

Parameter	Symbol	Limit	Unit
Input Voltage	V _{IN}	8	V
ON/OFF Voltage	V _{ON/OFF}	8	
Load Current	Continuous ^{a, b}	±2.9	A
	Pulsed ^{b, c}	±6	
Continuous Intrinsic Diode Conduction ^a	I _S	-1	
Maximum Power Dissipation ^a	P _D	0.83	W
Operating Junction and Storage Temperature Range	T _J , T _{stg}	-55 to 150	°C
ESD Rating, MIL-STD-883D Human Body Model (100 pF, 1500 Ω)	ESD	3	kV

THERMAL RESISTANCE RATINGS

Parameter	Symbol	Typical	Maximum	Unit
Maximum Junction-to-Ambient (continuous current) ^a	R _{thJA}	125	150	°C/W
Maximum Junction-to-Foot (Q2)	R _{thJC}	40	55	

SPECIFICATIONS (T_J = 25 °C UNLESS OTHERWISE NOTED)

Parameter	Symbol	Test Condition	Min	Typ	Max	Unit
OFF Characteristics						
Reverse Leakage Current	I _{FL}	V _{IN} = 8 V, V _{ON/OFF} = 0 V			1	μA
Diode Forward Voltage	V _{SD}	I _S = -1 A		-0.77	-1	V
ON Characteristics						
Input Voltage Range	V _{IN}		1.8		8	V
On-Resistance (p-channel) @ 1 A	r _{DS(on)}	V _{ON/OFF} = 1.5 V I _D = 1 A	V _{IN} = 4.5 V	0.045	0.060	Ω
			V _{IN} = 2.5 V	0.075	0.100	
			V _{IN} = 1.8 V	0.135	0.175	
On-State (p-channel) Drain-Current	I _{D(on)}	V _{IN-OUT} ≤ 0.2 V, V _{IN} = 5 V, V _{ON/OFF} = 1.5 V	1			A
		V _{IN-OUT} ≤ 0.3 V, V _{IN} = 3 V, V _{ON/OFF} = 1.5 V	1			

Notes

- Surface Mounted on FR4 Board.
- V_{IN} = 8 V, V_{ON/OFF} = 8 V, T_A = 25 °C.
- Pulse test: pulse width ≤ 300 μs, duty cycle ≤ 2%.



TYPICAL CHARACTERISTICS (25°C UNLESS NOTED)

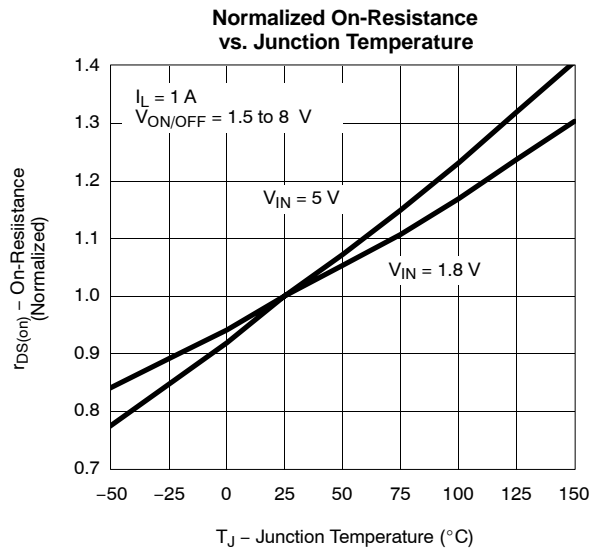
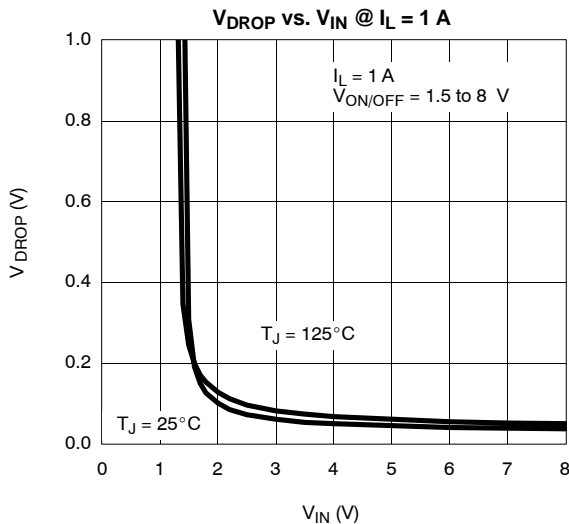
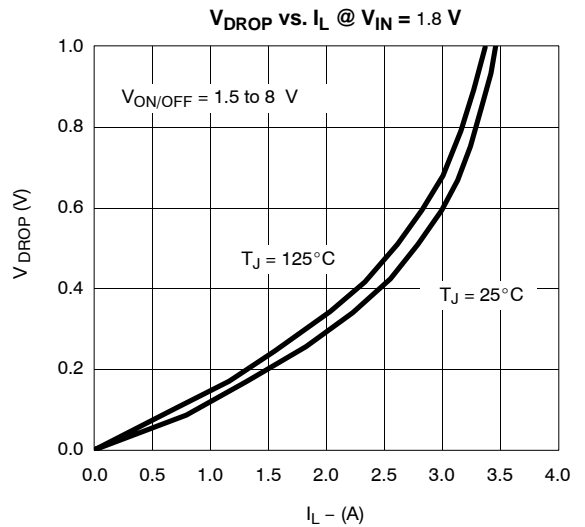
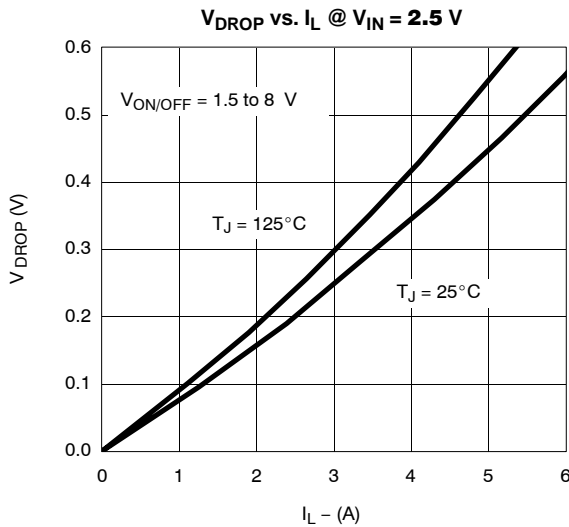
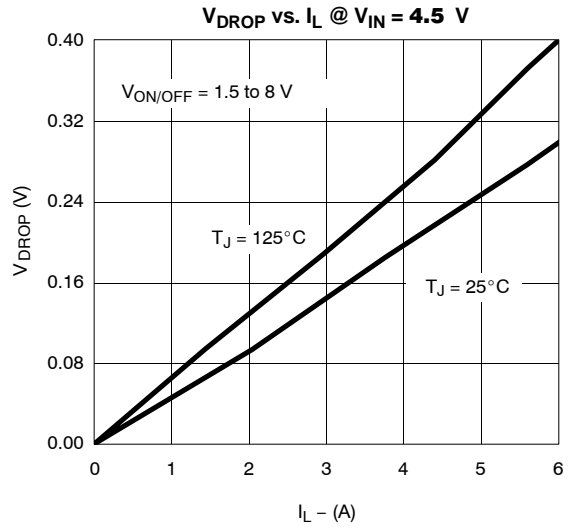
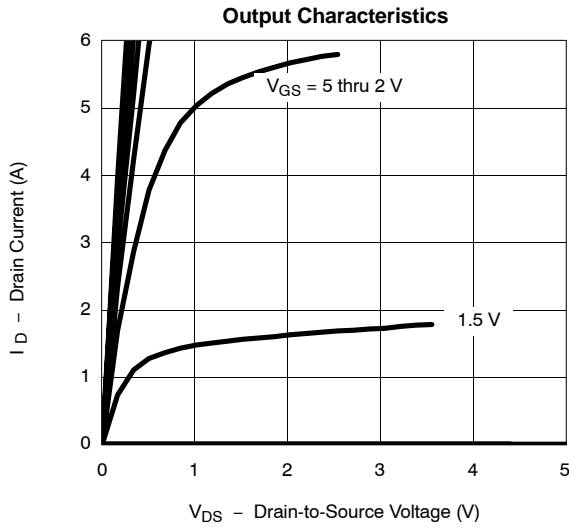



TYPICAL CHARACTERISTICS (25 °C UNLESS NOTED)

On-Resistance vs. Input Voltage

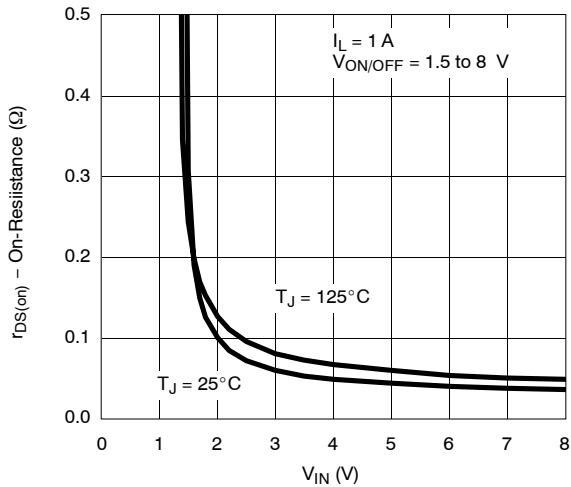

Source-Drain Diode Forward Voltage

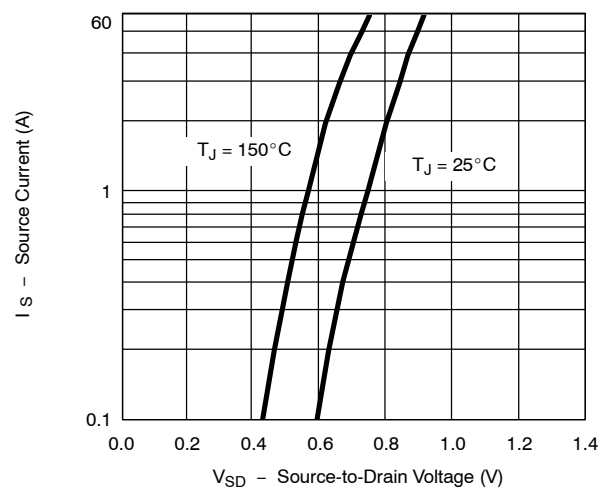

Switching Variation
R2 @ V_IN = 4.5 V, R1 = 20 kΩ

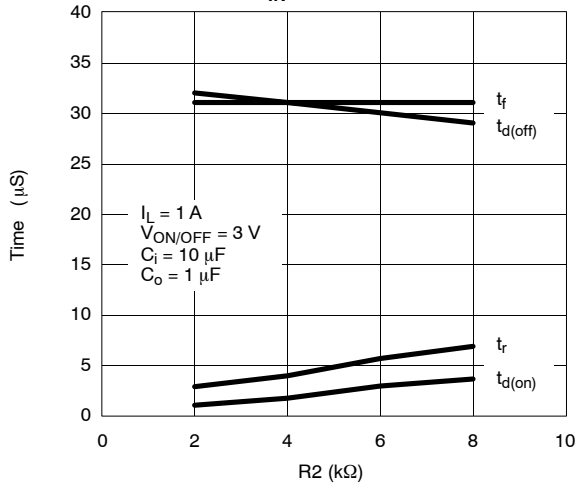

Switching Variation
R2 @ V_IN = 2.5 V, R1 = 20 kΩ

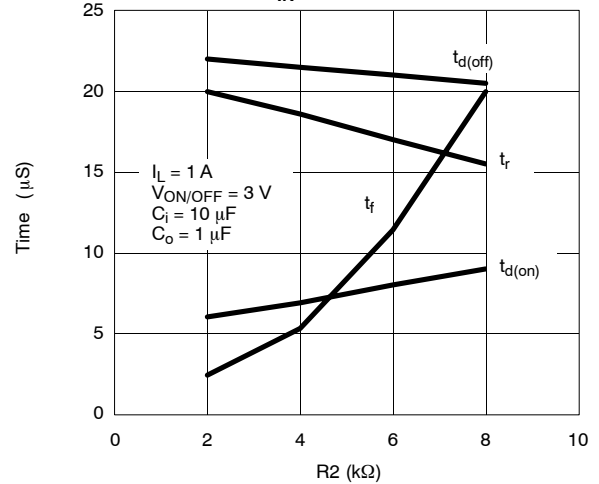

Switching Variation
R2 @ V_IN = 1.8 V, R1 = 20 kΩ

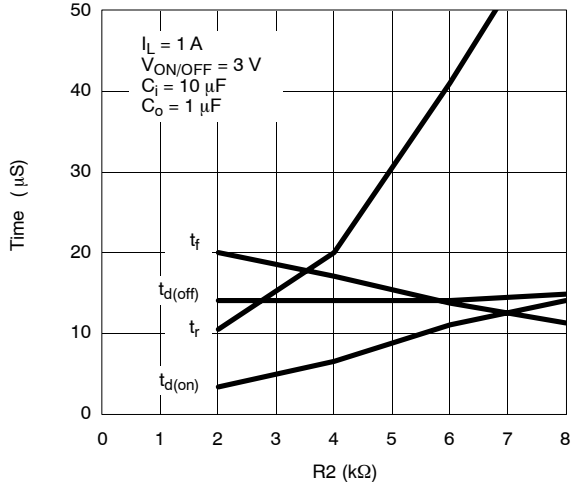

Switching Variation
R2 @ V_IN = 4.5 V, R1 = 300 kΩ

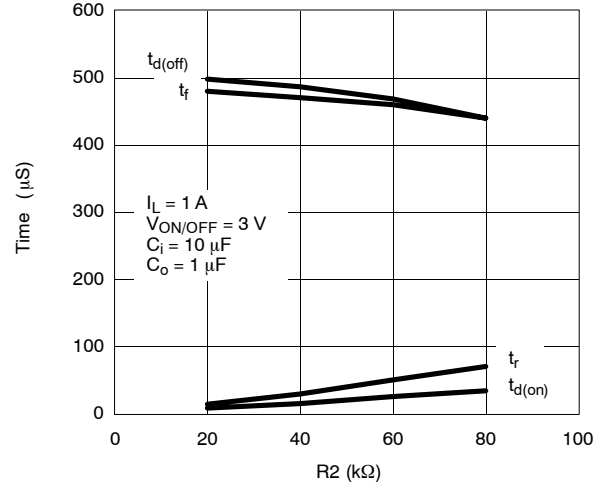



TYPICAL CHARACTERISTICS (25°C UNLESS NOTED)

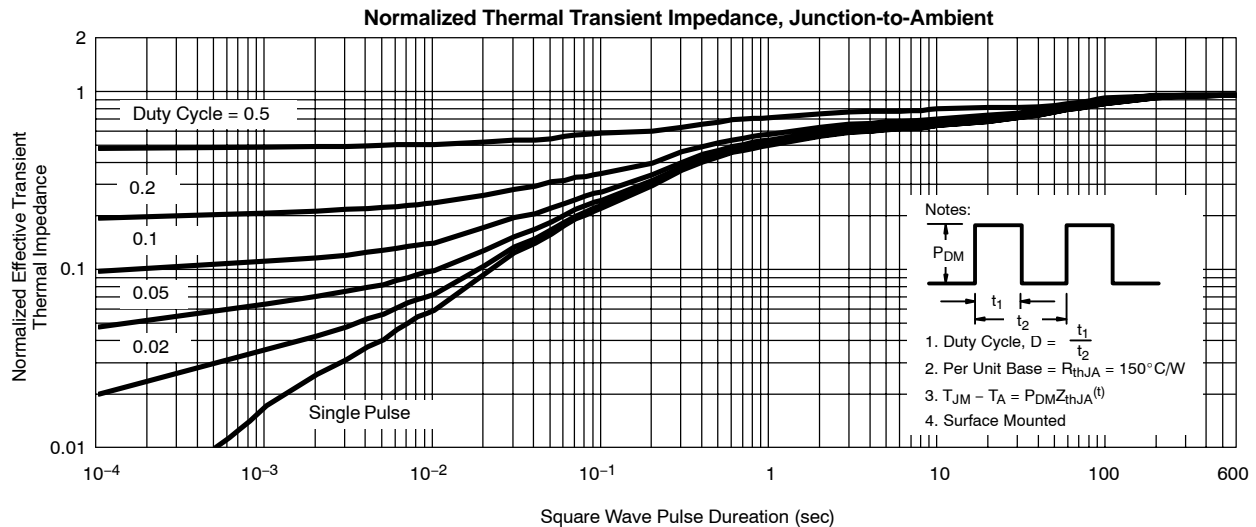
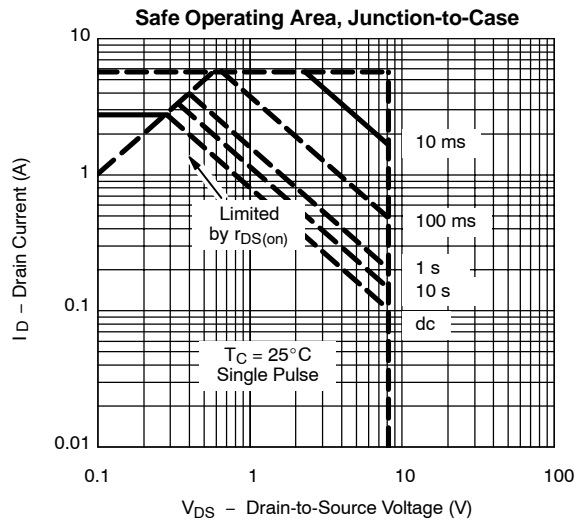
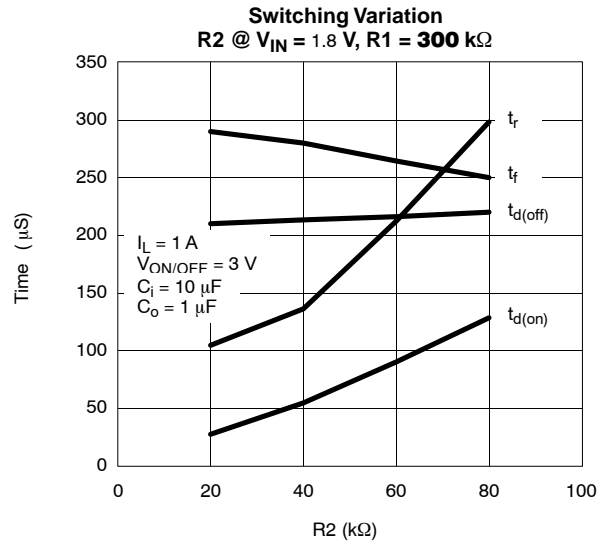
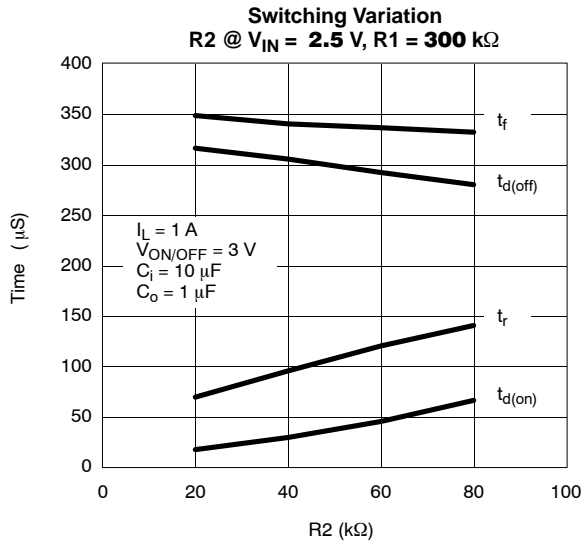



Disclaimer

All product specifications and data are subject to change without notice.

Vishay Intertechnology, Inc., its affiliates, agents, and employees, and all persons acting on its or their behalf (collectively, "Vishay"), disclaim any and all liability for any errors, inaccuracies or incompleteness contained herein or in any other disclosure relating to any product.

Vishay disclaims any and all liability arising out of the use or application of any product described herein or of any information provided herein to the maximum extent permitted by law. The product specifications do not expand or otherwise modify Vishay's terms and conditions of purchase, including but not limited to the warranty expressed therein, which apply to these products.

No license, express or implied, by estoppel or otherwise, to any intellectual property rights is granted by this document or by any conduct of Vishay.

The products shown herein are not designed for use in medical, life-saving, or life-sustaining applications unless otherwise expressly indicated. Customers using or selling Vishay products not expressly indicated for use in such applications do so entirely at their own risk and agree to fully indemnify Vishay for any damages arising or resulting from such use or sale. Please contact authorized Vishay personnel to obtain written terms and conditions regarding products designed for such applications.

Product names and markings noted herein may be trademarks of their respective owners.