

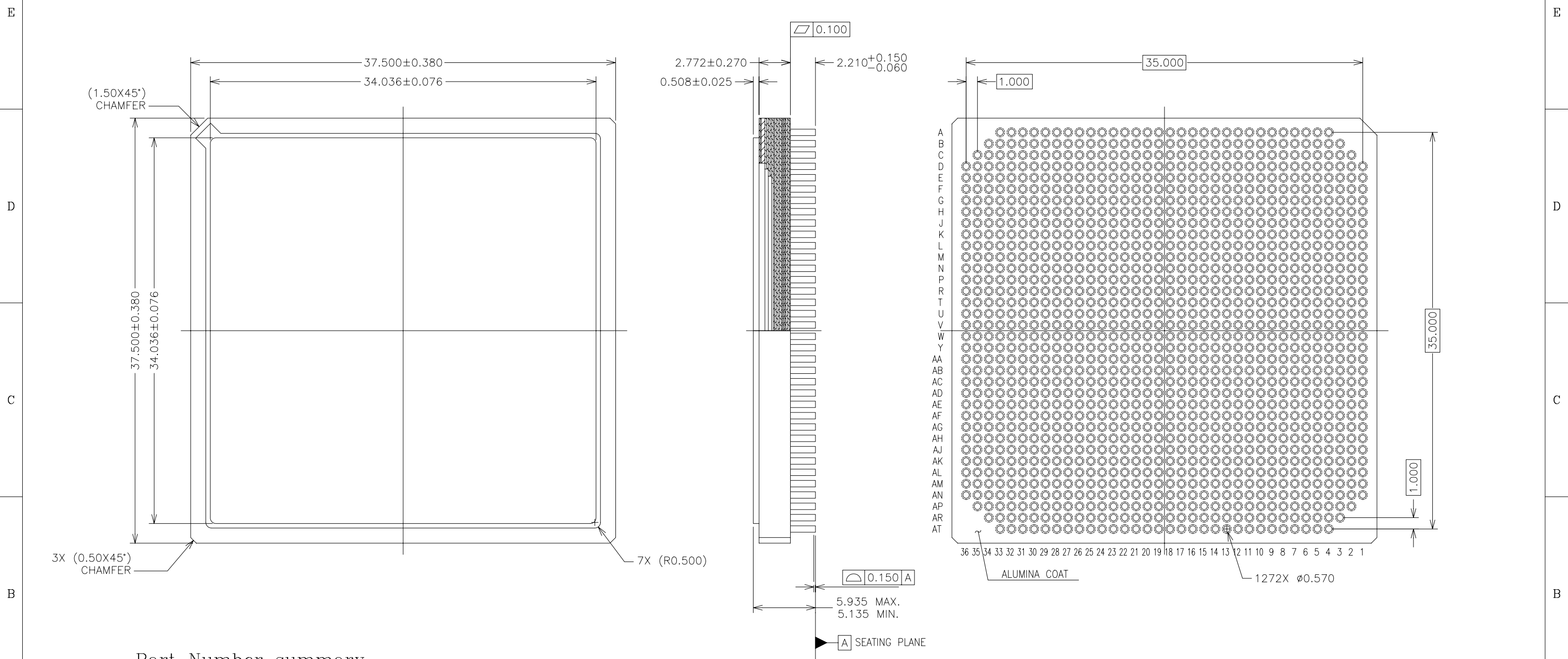

THE DRAWINGS AND INFORMATION CONTAINED HEREIN ARE THE EXCLUSIVE PROPERTY OF ACTEL.  
 THE INFORMATION, DRAWINGS AND DESIGN CONCEPTS CONTAINED HEREIN ARE CONFIDENTIAL/PROPRIETARY, SHALL  
 BE MAINTAINED IN STRICT CONFIDENCE, AND SHALL NOT BE RELEASED TO ANY THIRD PARTY WITHOUT THE EXPRESS  
 WRITTEN PERMISSION OF ACTEL.

ECN NO.	REV.	DESCRIPTION OF CHANGE	EFFECTIVE DATE	ORIGINATOR
2005122	0	New Release	3/08/2005	Erwin Q.
2005524	1	Edit part # summary and add LG1272 outline drawing on page 2	8/9/2005	Lijie Zhao



Part Number summary

Actel Part Number	Kyocera Part number	Description
YPKG-C7CG-A7A2DC	KD-NA5372	Blank LG1272 package (Refer page 3 to 9 for details)
LG1272 Daisy Chain		Assembled LG1272 package
CG1272 Daisy Chain		Assembled CG1272 package

GENERAL TOLERANCE	PROJECTION	 ACTEL CORPORATION 2061 STIERLIN COURT MOUNTAIN VIEW, CA 94043-4655		
	APPROVALS	DATE	TITLE	
DIMENSIONS:	DRAWN		CCGA1272, 37.5 MM X 37.5 MM, 1.0 MM PITCH, 1272 SOLDER COLUMNS, CERAMIC COLUMN GRID ARRAY, DAISY CHAIN PACKAGE	
Millimeters (mm)	Erwin Quiobo	3/08/2005	VENDOR NAME:	ACTEL DWG. NUMBER
	ENG'R		Kyocera	1-21-11573
	RELEASED		SIZE	VENDOR DWG. NUMBER
			B	KD-NA5372
				SCALE: NONE
				SHEET 1 OF 9

THE DRAWINGS AND INFORMATION CONTAINED HEREIN ARE THE EXCLUSIVE PROPERTY OF ACTEL.  
 THE INFORMATION, DRAWINGS AND DESIGN CONCEPTS CONTAINED HEREIN ARE CONFIDENTIAL/PROPRIETARY, SHALL  
 BE MAINTAINED IN STRICT CONFIDENCE, AND SHALL NOT BE RELEASED TO ANY THIRD PARTY WITHOUT THE EXPRESS  
 WRITTEN PERMISSION OF ACTEL.

ECN NO.	REV.	DESCRIPTION OF CHANGE	EFFECTIVE DATE	ORIGINATOR
2005122	0	New Release	3/08/2005	Erwin Q.
2005524	1	Edit part # summary and add LG1272 outline drawing on page 2	8/9/2005	Lijie Zhao

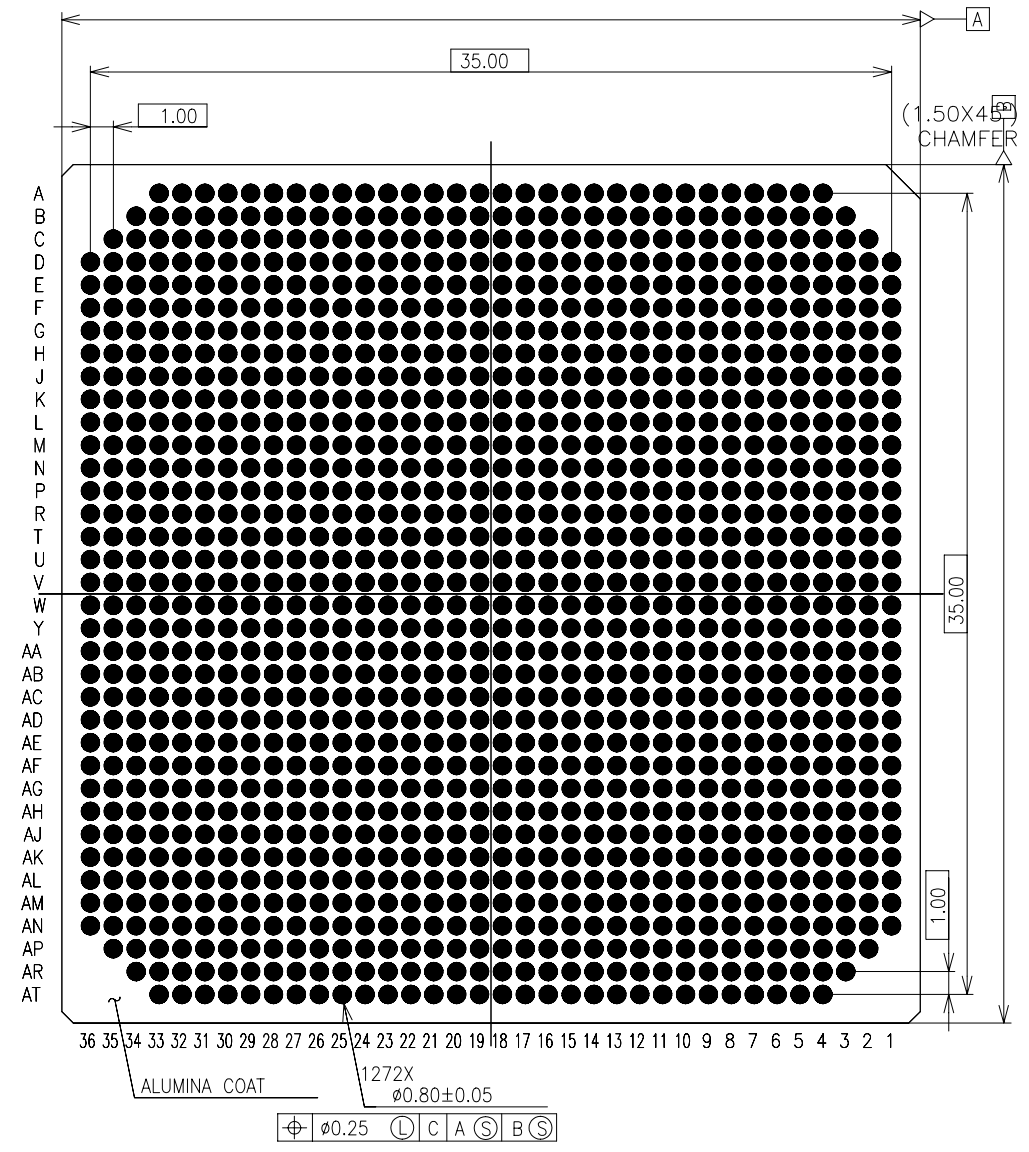
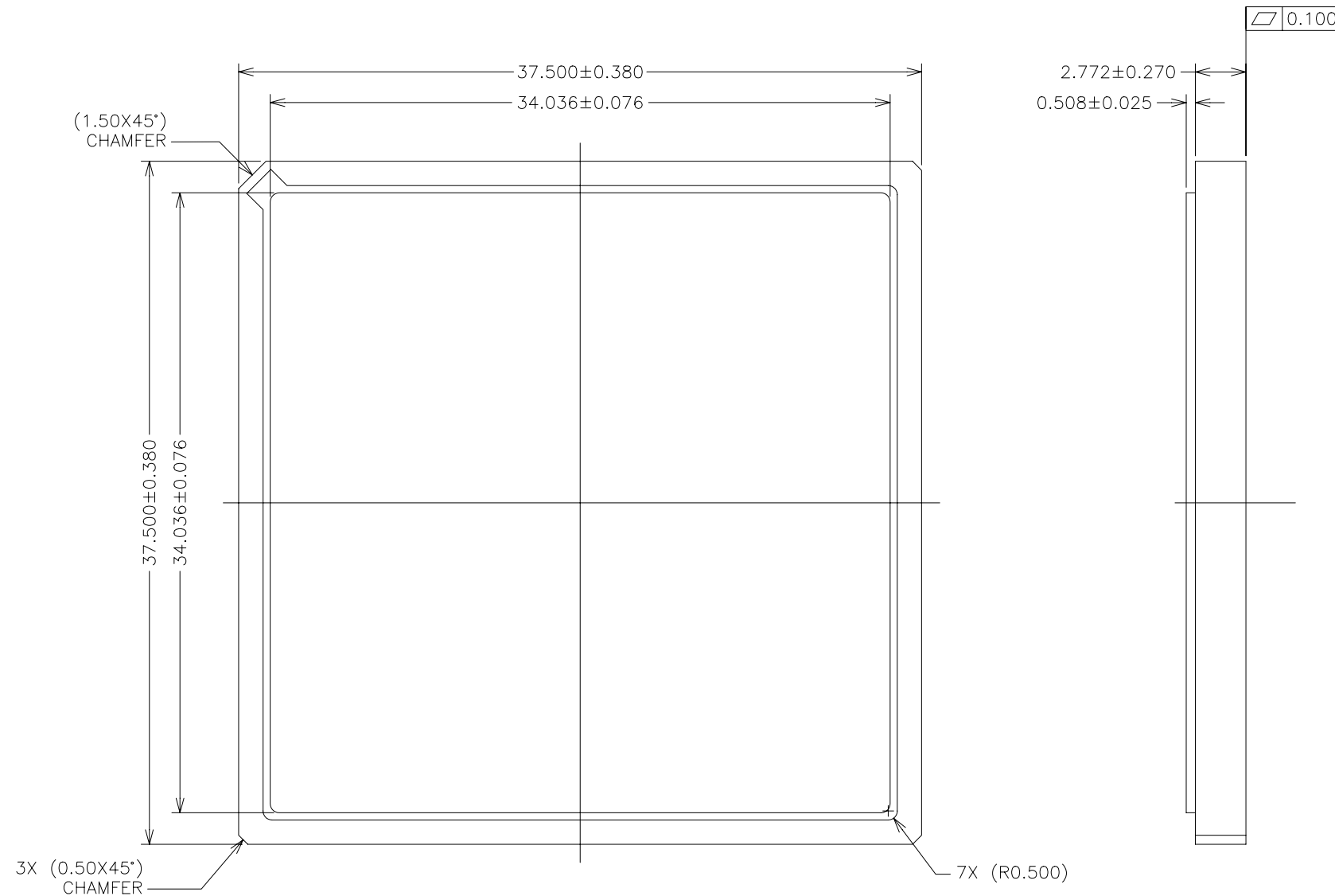

LG1272 outline drawing

GENERAL TOLERANCE	PROJECTION	 ACTEL CORPORATION 2061 STIERLIN COURT MOUNTAIN VIEW, CA 94043-4655		
	APPROVALS	DATE	TITLE	
DIMENSIONS:	DRAWN		CCGA1272, 37.5 MM X 37.5 MM, 1.0 MM PITCH, 1272 SOLDER COLUMNS, CERAMIC COLUMN GRID ARRAY, DAISY CHAIN PACKAGE	
Millimeters (mm)	Erwin Quiobo	3/08/2005	VENDOR NAME:	ACTEL DWG. NUMBER
	CHECKED		Kyocera	1-21-11573
	ENG'R		SIZE	REV
	RELEASED		B	A
			Actel Package Part Number	VENDOR DWG. NUMBER
			See Part Number Table	KD-NA5372
			SCALE: NONE	SHEET 2 OF 9

THE DRAWINGS AND INFORMATION CONTAINED HEREIN ARE THE EXCLUSIVE PROPERTY OF ACTEL.  
 THE INFORMATION, DRAWINGS AND DESIGN CONCEPTS CONTAINED HEREIN ARE CONFIDENTIAL/PROPRIETARY, SHALL  
 BE MAINTAINED IN STRICT CONFIDENCE, AND SHALL NOT BE RELEASED TO ANY THIRD PARTY WITHOUT THE EXPRESS  
 WRITTEN PERMISSION OF ACTEL.

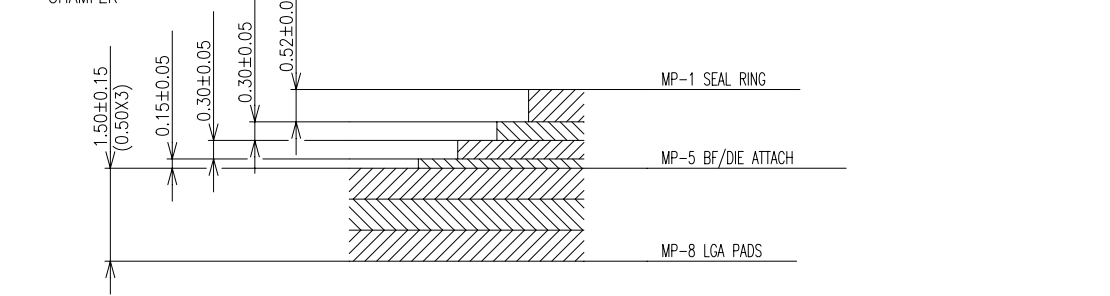
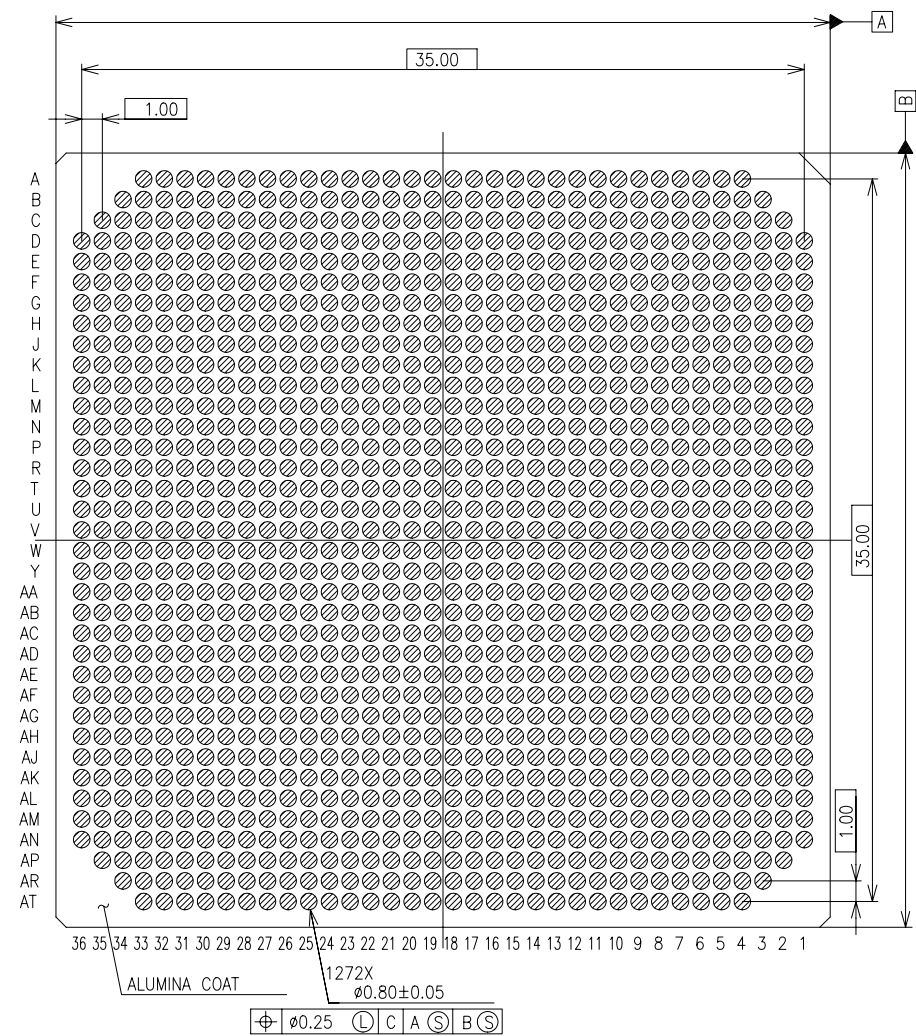
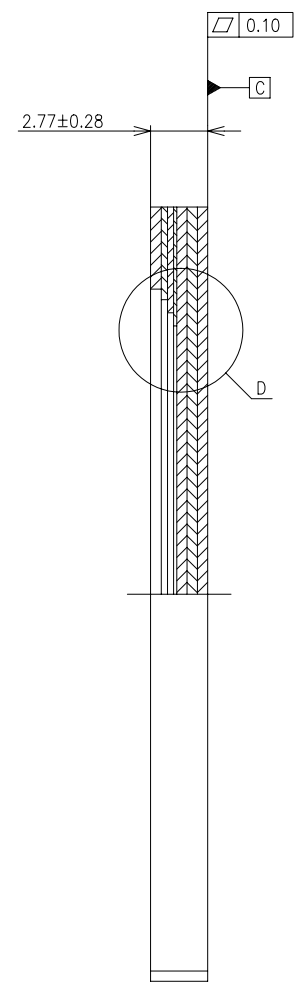
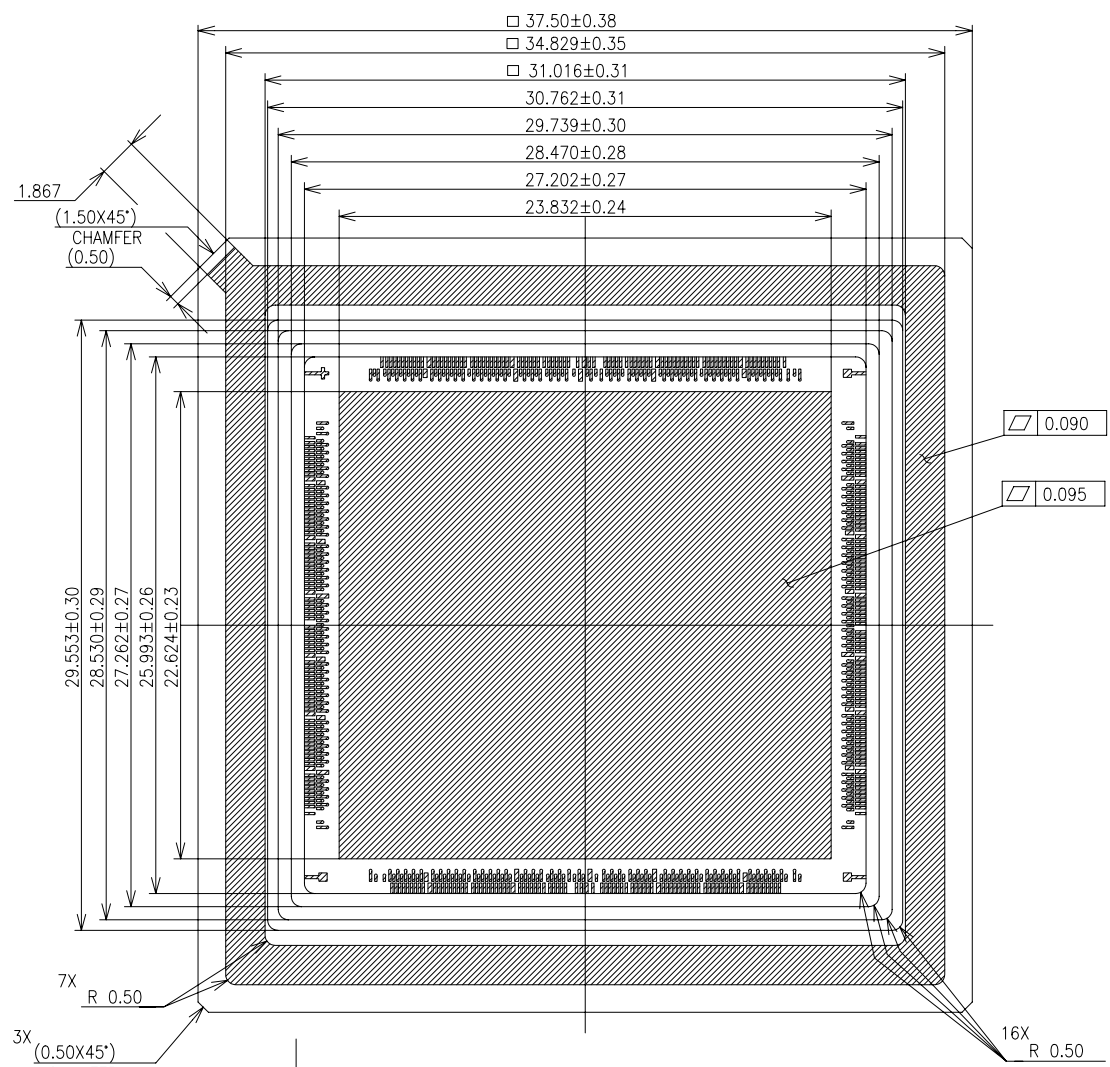

DETAIL D

- NOTES:
1. PLATING  
 TOP : ELECTROLESS Ni 3.20~8.89 MICRON.  
 TOP : ELECTROLESS Au 2.50 MICRON MIN.  
 BOTTOM : ELECTROLESS Ni 3.20~8.89 MICRON.  
 BOTTOM : ELECTROLESS Au 0.03~0.10 MICRON.
  2. SEAL AREA TO BE METALLIZED.
  3. DIE ATTACH AREA TO BE METALLIZED.
  4. SEAL AREA, DIE ATTACH AREA AND FIDUCIAL MARK TO BE FLOATING FROM ANY PADS.
  5. BOND FINGERS CONNECTION SHOULD BE VENDOR'S OPTION.
  6. OPEN/SHORT CHECK TO BE PERFORMED ONLY TO LGA PADS.
  7. NO VISUAL INSPECTION IS REQUIRED FOR THE FIDUCIAL MARK AND BOND FINGERS AREA.

SIZE B	ACTEL DWG. NUMBER 1-21-11573	REV 1
	VENDOR DWG. NUMBER KD-NA5372	REV A
SCALE: NONE		SHEET 3 OF 9

THE DRAWINGS AND INFORMATION CONTAINED HEREIN ARE THE EXCLUSIVE PROPERTY OF ACTEL.  
 THE INFORMATION, DRAWINGS AND DESIGN CONCEPTS CONTAINED HEREIN ARE CONFIDENTIAL/PROPRIETARY, SHALL  
 BE MAINTAINED IN STRICT CONFIDENCE, AND SHALL NOT BE RELEASED TO ANY THIRD PARTY WITHOUT THE EXPRESS  
 WRITTEN PERMISSION OF ACTEL.

CONNECTION TABLE(1/2)

LGA No.	LGA No.	LGA No.	LGA No.	LGA No.	LGA No.	LGA No.	LGA No.	LGA No.	LGA No.	LGA No.	LGA No.	LGA No.	LGA No.	LGA No.	LGA No.
A4	AA11	AB16	AC21	AD27	AE32	AG2	AH6	AJ11	AK16	AL21	AM26	AN31	AR7	AT16	B25
A5	AB11	AB17	AC22	AE27	AF32	AH2	AJ6	AJ12	AK17	AL22	AM27	AN32	AR8	AT17	B26
A6	AA13	AB18	AC24	AD29	AE34	AG3	AH8	AJ13	AK18	AL23	AM28	AN34	AR9	AT18	B27
A7	AB13	AB19	AD24	AE29	AF34	AH3	AJ8	AJ14	AK19	AL24	AM29	AP34	AR10	AT19	B28
A8	AA15	AB20	AC26	AD31	AE35	AG5	AH10	AJ15	AK20	AL25	AM30	AN35	AR11	AT20	B29
A9	AB15	AB21	AD26	AE31	AF35	AH5	AH11	AJ16	AK21	AL26	AM31	AP35	AR12	AT21	B30
A10	AA17	AB23	AC28	AD33	AF1	AG7	AH12	AJ17	AK22	AL27	AM33	AP4	AR13	AT22	B31
A11	AA18	AC23	AD28	AE33	AG1	AH7	AH13	AJ18	AK23	AL28	AN33	AP5	AR14	AT23	B32
A12	AA19	AB25	AC30	AD36	AF4	AG9	AH14	AJ19	AK24	AL29	AM36	AP6	AR15	AT24	B33
A13	AA20	AC25	AD30	AE36	AG4	AH9	AH15	AJ20	AK25	AL30	AN36	AP7	AR16	AT25	B34
A14	AA22	AB27	AC32	AE2	AF6	AG11	AH16	AJ21	AK26	AL32	AN2	AP8	AR17	AT26	C2
A15	AB22	AC27	AD32	AF2	AG6	AG12	AH17	AJ22	AK27	AM32	AP2	AP9	AR18	AT27	D2
A16	AA24	AB29	AC34	AE3	AF8	AG13	AH18	AJ23	AK28	AL34	AN3	AP10	AR19	AT28	C3
A17	AB24	AC29	AD34	AF3	AG8	AG14	AH19	AJ24	AK29	AM34	AP3	AP11	AR20	AT29	D3
A18	AA26	AB31	AC35	AE5	AF10	AG15	AH20	AJ25	AK31	AL35	AN5	AP12	AR21	AT30	C4
A19	AB26	AC31	AD35	AF5	AG10	AG16	AH21	AJ26	AL31	AM35	AN6	AP13	AR22	AT31	C5
A20	AA28	AB33	AD1	AE7	AF12	AG17	AH22	AJ27	AK33	AM1	AN7	AP14	AR23	AT32	C6
A21	AB28	AC33	AE1	AF7	AF13	AG18	AH23	AJ28	AL33	AN1	AN8	AP15	AR24	AT33	C7
A22	AA30	AB36	AD4	AE9	AF14	AG19	AH24	AJ30	AK36	AM4	AN9	AP16	AR25	B3	C8
A23	AB30	AC36	AE4	AF9	AF15	AG20	AH25	AK30	AL36	AN4	AN10	AP17	AR26	B4	C9
A24	AA32	AC2	AD6	AE11	AF16	AG21	AH26	AJ32	AL2	AM6	AN11	AP18	AR27	B5	C10
A25	AB32	AD2	AE6	AF11	AF17	AG22	AH27	AK32	AM2	AM7	AN12	AP19	AR28	B6	C11
A26	AA34	AC3	AD8	AE13	AF18	AG23	AH29	AJ34	AL3	AM8	AN13	AP20	AR29	B7	C12
A27	AB34	AD3	AE8	AE14	AF19	AG24	AJ29	AK34	AM3	AM9	AN14	AP21	AR30	B8	C13
A28	AA35	AC5	AD10	AE15	AF20	AG25	AH31	AJ35	AL5	AM10	AN15	AP22	AR31	B9	C14
A29	AB35	AD5	AE10	AE16	AF21	AG26	AJ31	AK35	AM5	AM11	AN16	AP23	AR32	B10	C15
A30	AB1	AC7	AD12	AE17	AF22	AG28	AH33	AK1	AL7	AM12	AN17	AP24	AR33	B11	C16
A31	AC1	AD7	AE12	AE18	AF23	AH28	AJ33	AL1	AL8	AM13	AN18	AP25	AR34	B12	C17
A32	AB4	AC9	AD14	AE19	AF24	AG30	AH36	AK4	AL9	AM14	AN19	AP26	AT4	B13	C18
A33	AC4	AD9	AD15	AE20	AF25	AH30	AJ36	AL4	AL10	AM15	AN20	AP27	AT5	B14	C19
AA2	AB6	AC11	AD16	AE21	AF27	AG32	AJ2	AK6	AL11	AM16	AN21	AP28	AT6	B15	C20
AB2	AC6	AD11	AD17	AE22	AG27	AH32	AK2	AL6	AL12	AM17	AN22	AP29	AT7	B16	C21
AA3	AB8	AC13	AD18	AE23	AF29	AG34	AJ3	AK8	AL13	AM18	AN23	AP30	AT8	B17	C22
AB3	AC8	AD13	AD19	AE24	AG29	AH34	AK3	AK9	AL14	AM19	AN24	AP31	AT9	B18	C23
AA5	AB10	AC15	AD20	AE26	AF31	AG35	AJ5	AK10	AL15	AM20	AN25	AP32	AT10	B19	C24
AB5	AC10	AC16	AD21	AF26	AG31	AH35	AK5	AK11	AL16	AM21	AN26	AP33	AT11	B20	C25
AA7	AB12	AC17	AD22	AE28	AF33	AH1	AJ7	AK12	AL17	AM22	AN27	AR3	AT12	B21	C26
AB7	AC12	AC18	AD23	AF28	AG33	AJ1	AK7	AK13	AL18	AM23	AN28	AR4	AT13	B22	C27
AA9	AB14	AC19	AD25	AE30	AF36	AH4	AJ9	AK14	AL19	AM24	AN29	AR5	AT14	B23	C28
AB9	AC14	AC20	AE25	AF30	AG36	AJ4	AJ10	AK15	AL20	AM25	AN30	AR6	AT15	B24	C29

SIZE B	ACTEL DWG. NUMBER 1-21-11573	REV 1
	VENDOR DWG. NUMBER KD-NA5372	REV A
SCALE: NONE		SHEET 4 OF 9

THE DRAWINGS AND INFORMATION CONTAINED HEREIN ARE THE EXCLUSIVE PROPERTY OF ACTEL.  
 THE INFORMATION, DRAWINGS AND DESIGN CONCEPTS CONTAINED HEREIN ARE CONFIDENTIAL/PROPRIETARY, SHALL  
 BE MAINTAINED IN STRICT CONFIDENCE, AND SHALL NOT BE RELEASED TO ANY THIRD PARTY WITHOUT THE EXPRESS  
 WRITTEN PERMISSION OF ACTEL.

CONNECTION TABLE(2/2)

LGA No.	LGA No.	LGA No.	LGA No.	LGA No.	LGA No.	LGA No.	LGA No.	LGA No.	LGA No.	LGA No.	LGA No.	LGA No.	LGA No.	LGA No.	LGA No.
C30	D33	E35	G3	H6	J9	K11	L14	M17	N20	P23	R26	T29	U32	V36	Y4
C31	E33	F35	H3	J6	K9	K12	L15	M18	N21	R23	T26	U29	V32	W36	AA4
C32	D36	F1	G5	H8	J10	K13	L16	M19	N22	P25	R28	T31	U34	W2	Y6
C33	E36	G1	H5	J8	J11	K14	L17	M20	N23	R25	T28	U31	V34	Y2	AA6
C34	E2	F4	G7	H9	J12	K15	L18	M21	N24	P27	R30	T33	U35	W3	Y8
D34	F2	G4	H7	H10	J13	K16	L19	M22	P24	R27	T30	U33	V35	Y3	AA8
C35	E3	F6	G8	H11	J14	K17	L20	M23	N26	P29	R32	T36	V1	W5	Y10
D35	F3	G6	G9	H12	J15	K18	L21	M24	P26	R29	T32	U36	W1	Y5	AA10
D1	E5	F7	G10	H13	J16	K19	L22	M25	N28	P31	R34	U2	V4	W7	Y12
E1	F5	F8	G11	H14	J17	K20	L23	N25	P28	R31	T34	V2	W4	Y7	AA12
D4	E6	F9	G12	H15	J18	K21	L24	M27	N30	P33	R35	U3	V6	W9	Y14
E4	E7	F10	G13	H16	J19	K22	L25	N27	P30	R33	T35	V3	W6	Y9	AA14
D5	E8	F11	G14	H17	J20	K23	L26	M29	N32	P36	T1	U5	V8	W11	Y16
D6	E9	F12	G15	H18	J21	K24	M26	N29	P32	R36	U1	V5	W8	Y11	AA16
D7	E10	F13	G16	H19	J22	K25	L28	M31	N34	R2	T4	U7	V10	W13	Y18
D8	E11	F14	G17	H20	J23	K26	M28	N31	P34	T2	U4	V7	W10	Y13	Y19
D9	E12	F15	G18	H21	J24	K27	L30	M33	N35	R3	T6	U9	V12	W15	Y21
D10	E13	F16	G19	H22	J25	L27	M30	N33	P35	T3	U6	V9	W12	Y15	AA21
D11	E14	F17	G20	H23	J26	K29	L32	M36	P1	R5	T8	U11	V14	W17	Y23
D12	E15	F18	G21	H24	J27	L29	M32	N36	R1	T5	U8	V11	W14	Y17	AA23
D13	E16	F19	G22	H25	J28	K31	L34	N2	P4	R7	T10	U13	V16	W20	Y25
D14	E17	F20	G23	H26	K28	L31	M34	P2	R4	T7	U10	V13	W16	Y20	AA25
D15	E18	F21	G24	H27	J30	K33	L35	N3	P6	R9	T12	U15	V18	W22	Y27
D16	E19	F22	G25	H28	K30	L33	M35	P3	R6	T9	U12	V15	W18	Y22	AA27
D17	E20	F23	G26	H29	J32	K36	M1	N5	P8	R11	T14	U17	V19	W24	Y29
D18	E21	F24	G27	J29	K32	L36	N1	P5	R8	T11	U14	V17	W19	Y24	AA29
D19	E22	F25	G28	H31	J34	L2	M4	N7	P10	R13	T16	U18	V21	W26	Y31
D20	E23	F26	G29	J31	K34	M2	N4	P7	R10	T13	U16	U19	V21	Y26	AA31
D21	E24	F27	G30	H33	J35	L3	M6	N9	P12	R15	T17	U20	V23	W28	Y33
D22	E25	F28	H30	J33	K35	M3	N6	P9	R12	T15	T18	V20	W23	Y28	AA33
D23	E26	F29	G32	H36	K1	L5	M8	N11	P14	R16	T19	U22	V25	W30	Y36
D24	E27	F30	H32	J36	L1	M5	N8	P11	R14	R17	T20	V22	W25	Y30	AA36
D25	E28	F31	G34	J2	K4	L7	M10	N13	P15	R18	T21	U24	V27	W32	
D26	E29	G31	H34	K2	L4	M7	N10	P13	P16	R19	U21	V24	W27	Y32	
D27	E30	F33	G35	J3	K6	L9	M12	N14	P17	R20	T23	U26	V29	W34	
D28	E31	G33	H35	K3	L6	M9	N12	N15	P18	R21	U23	V26	W29	Y34	
D29	E32	F36	H1	J5	K8	L11	M13	N16	P19	R22	T25	U28	V31	W35	
D30	F32	G36	J1	K5	L8	M11	M14	N17	P20	T22	U25	V28	W31	Y35	
D31	E34	G2	H4	J7	K10	L12	M15	N18	P21	R24	T27	U30	V33	Y1	
D32	F34	H2	J4	K7	L10	L13	M16	N19	P22	T24	U27	V30	W33	AA1	

S/R	NC
D/A	NC

SIZE B	ACTEL DWG. NUMBER 1-21-11573	REV 1
	VENDOR DWG. NUMBER KD-NA5372	REV A
SCALE: NONE		SHEET 5 OF 9

THE DRAWINGS AND INFORMATION CONTAINED HEREIN ARE THE EXCLUSIVE PROPERTY OF ACTEL.  
 THE INFORMATION, DRAWINGS AND DESIGN CONCEPTS CONTAINED HEREIN ARE CONFIDENTIAL/PROPRIETARY, SHALL  
 BE MAINTAINED IN STRICT CONFIDENCE, AND SHALL NOT BE RELEASED TO ANY THIRD PARTY WITHOUT THE EXPRESS  
 WRITTEN PERMISSION OF ACTEL.

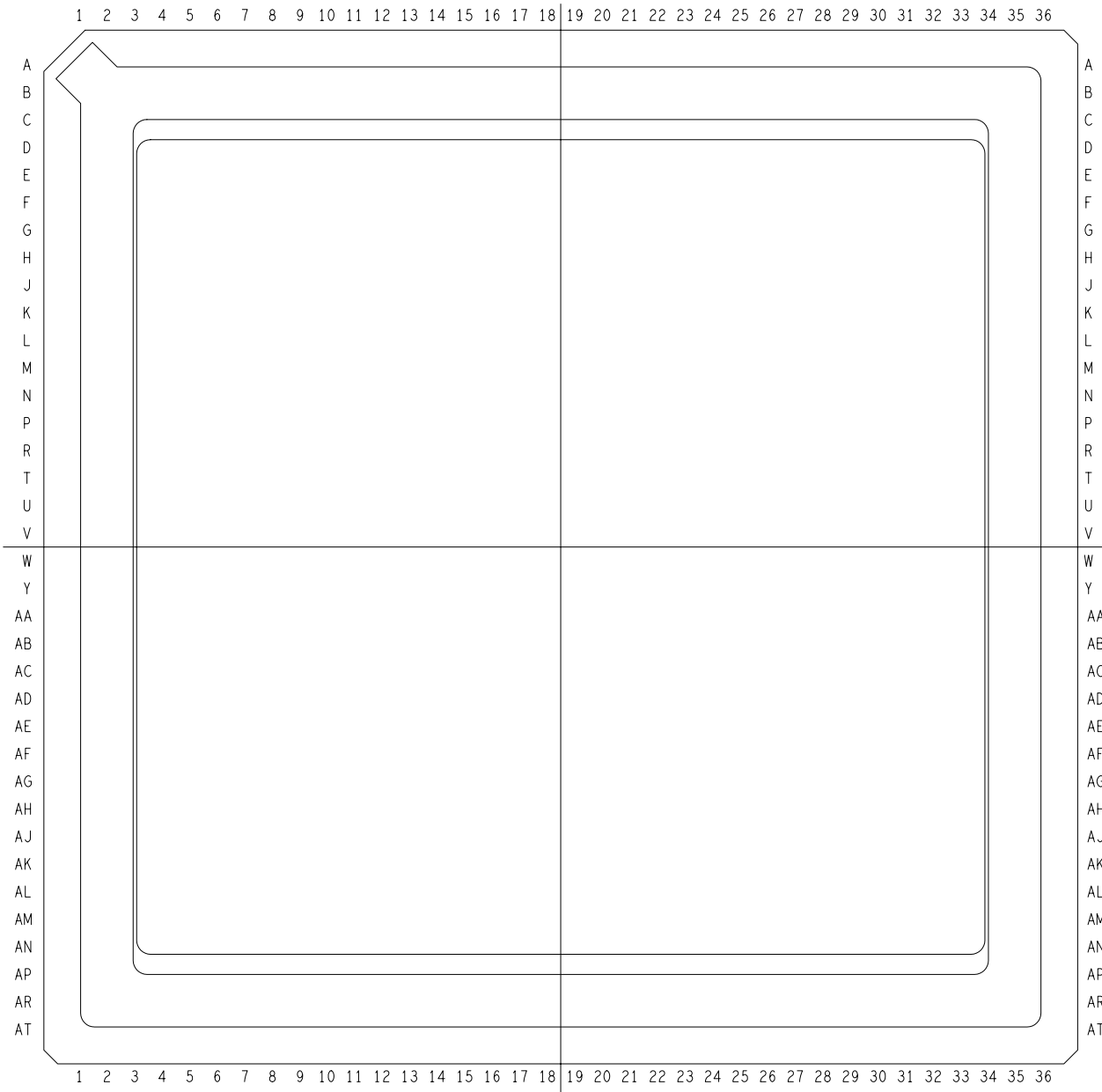

MP-1  
SEAL RING

SIZE B	ACTEL DWG. NUMBER 1-21-11573	REV 1
	VENDOR DWG. NUMBER KD-NA5372	REV A
SCALE: NONE		SHEET 6 OF 9

THE DRAWINGS AND INFORMATION CONTAINED HEREIN ARE THE EXCLUSIVE PROPERTY OF ACTEL.  
 THE INFORMATION, DRAWINGS AND DESIGN CONCEPTS CONTAINED HEREIN ARE CONFIDENTIAL/PROPRIETARY, SHALL  
 BE MAINTAINED IN STRICT CONFIDENCE, AND SHALL NOT BE RELEASED TO ANY THIRD PARTY WITHOUT THE EXPRESS  
 WRITTEN PERMISSION OF ACTEL.

E

E

1 2 3 4 5 6 7 8 9 10 11 12 13 14 15 16 17 18 19 20 21 22 23 24 25 26 27 28 29 30 31 32 33 34 35 36

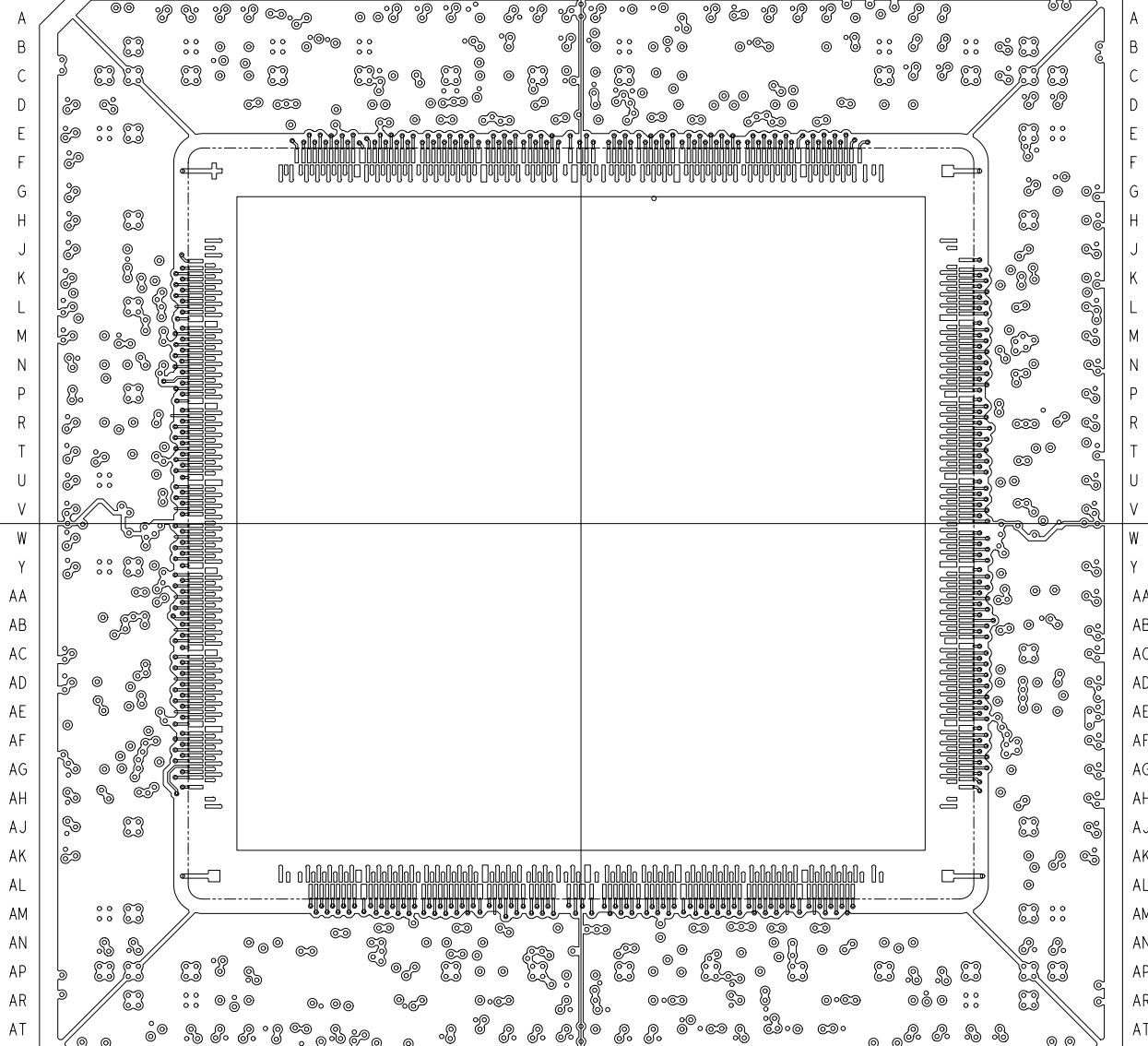

MP-5  
 BF/DIE ATTACH

D

D

C

C

B

B

A

A

SIZE B	ACTEL DWG. NUMBER 1-21-11573	REV 1
	VENDOR DWG. NUMBER KD-NA5372	REV A
SCALE: NONE		SHEET 7 OF 9

THE DRAWINGS AND INFORMATION CONTAINED HEREIN ARE THE EXCLUSIVE PROPERTY OF ACTEL.  
 THE INFORMATION, DRAWINGS AND DESIGN CONCEPTS CONTAINED HEREIN ARE CONFIDENTIAL/PROPRIETARY, SHALL  
 BE MAINTAINED IN STRICT CONFIDENCE, AND SHALL NOT BE RELEASED TO ANY THIRD PARTY WITHOUT THE EXPRESS  
 WRITTEN PERMISSION OF ACTEL.

E

E

D

D

C

C

B

B

A

A

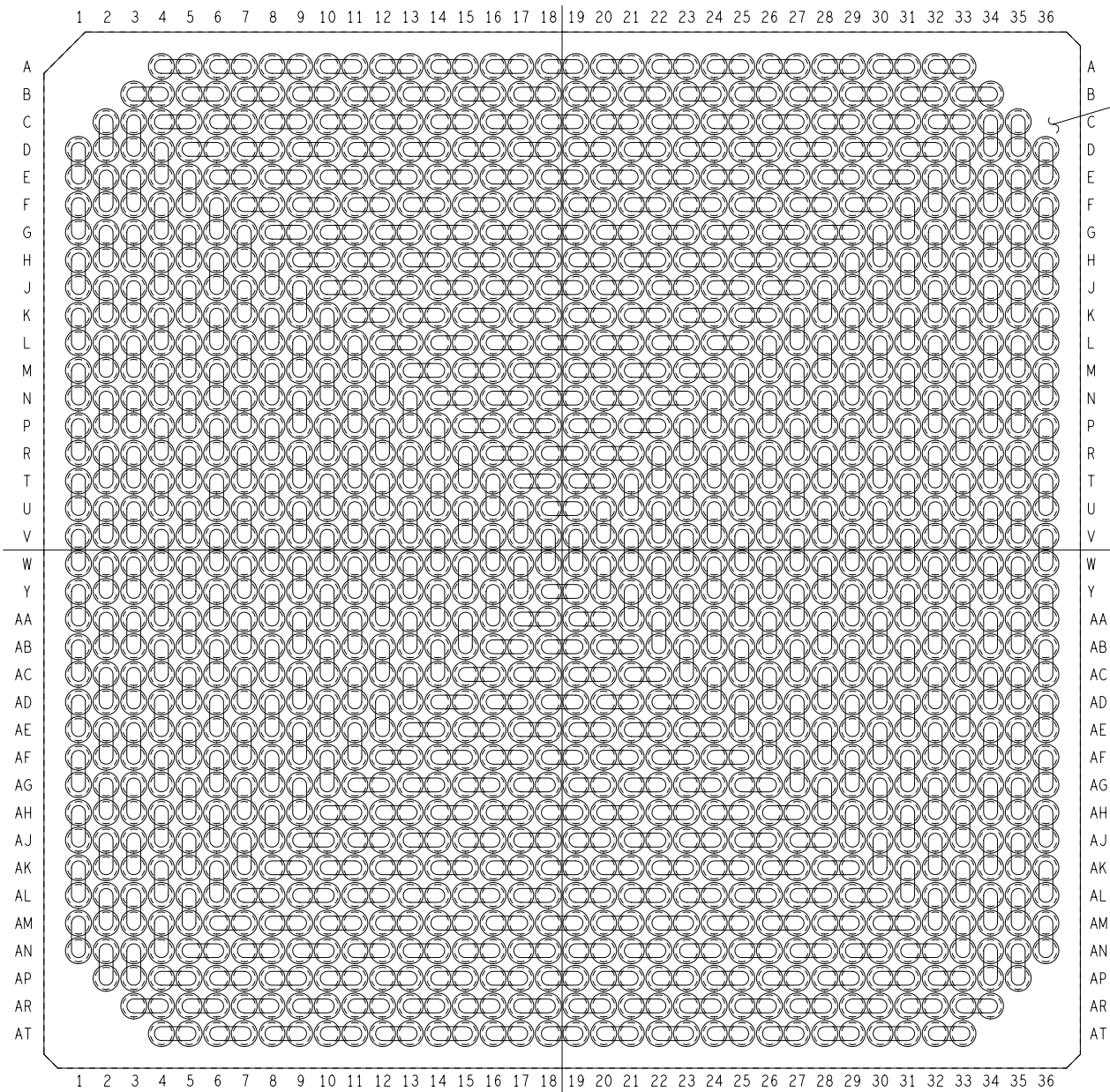

ALUMINA COAT

MP-8  
 LGA PADS  
 (TOP VIEW)

SIZE B	ACTEL DWG. NUMBER 1-21-11573	REV 1
	VENDOR DWG. NUMBER KD-NA5372	REV A
SCALE: NONE		SHEET 8 OF 9



THE DRAWINGS AND INFORMATION CONTAINED HEREIN ARE THE EXCLUSIVE PROPERTY OF ACTEL.  
 THE INFORMATION, DRAWINGS AND DESIGN CONCEPTS CONTAINED HEREIN ARE CONFIDENTIAL/PROPRIETARY, SHALL  
 BE MAINTAINED IN STRICT CONFIDENCE, AND SHALL NOT BE RELEASED TO ANY THIRD PARTY WITHOUT THE EXPRESS  
 WRITTEN PERMISSION OF ACTEL.

E

E

D

D

C

C

B

B

A

A

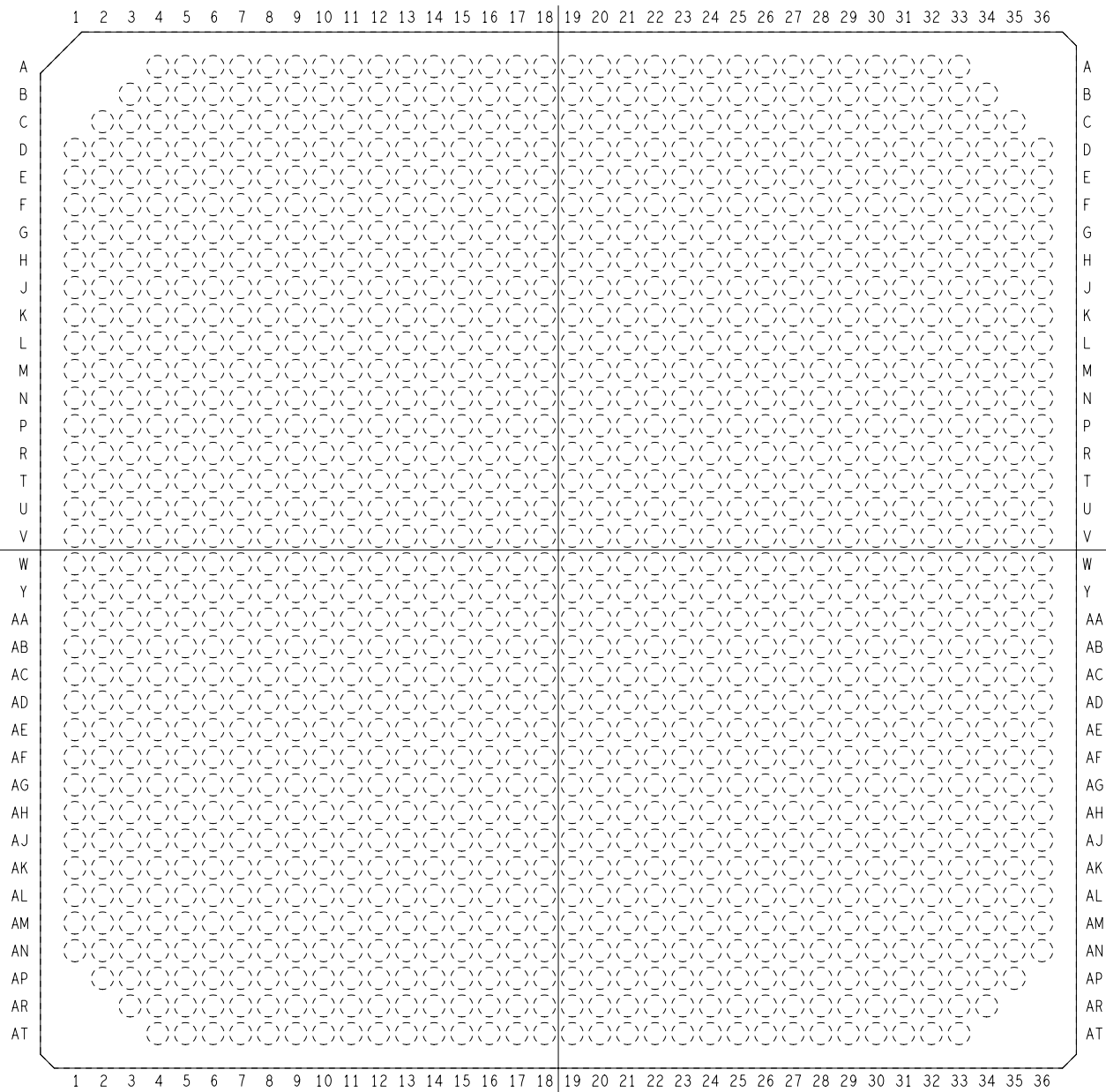

ALUMINA COAT  
 (MP-8)  
 (TOP VIEW)

SIZE B	ACTEL DWG. NUMBER 1-21-11573	REV 1
	VENDOR DWG. NUMBER KD-NA5372	REV A
SCALE: NONE		SHEET 9 OF 9