

Silicon NPN Power Transistors

2SC3834

DESCRIPTION

- Switching transistor
- With TO-220 package

APPLICATIONS

- For humidifier ,DC-DC converter and general purpose applications

PINNING

PIN	DESCRIPTION
1	Base
2	Collector;connected to mounting base
3	Emitter

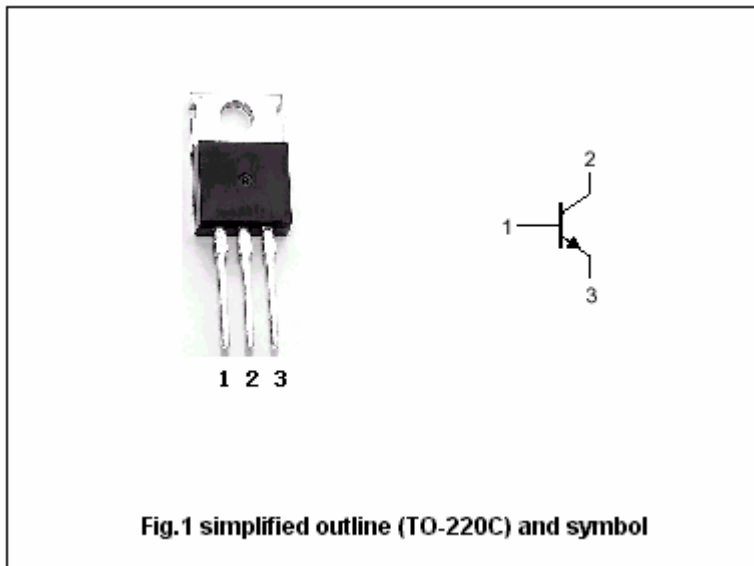

Absolute maximum ratings (Ta=25℃)

SYMBOL	PARAMETER	CONDITIONS	VALUE	UNIT
V_{CBO}	Collector-base voltage	Open emitter	200	V
V_{CEO}	Collector-emitter voltage	Open base	120	V
V_{EBO}	Emitter-base voltage	Open collector	8	V
I_C	Collector current (DC)		7	A
I_{CM}	Collector current-peak		14	A
I_B	Base current (DC)		3	A
P_C	Collector power dissipation	$T_C=25^\circ\text{C}$	50	W
T_j	Junction temperature		150	℃
T_{stg}	Storage temperature		-55~150	℃

Silicon NPN Power Transistors

2SC3834

CHARACTERISTICS

T_j=25 °C unless otherwise specified

SYMBOL	PARAMETER	CONDITIONS	MIN	TYP.	MAX	UNIT
V _{(BR)CEO}	Collector-emitter breakdown voltage	I _C =50mA ; I _B =0	120			V
V _{CE(sat)}	Collector-emitter saturation voltage	I _C =3A ; I _B =0.3A			0.5	V
V _{BE(sat)}	Base-emitter saturation voltage	I _C =3A ; I _B =0.3A			1.2	V
I _{CBO}	Collector cut-off current	V _{CB} =200V ; I _E =0			0.1	mA
I _{EBO}	Emitter cut-off current	V _{EB} =8V ; I _C =0			0.1	mA
h _{FE-1}	DC current gain	I _C =0.6A ; V _{CE} =4V	70		250	
h _{FE-2}	DC current gain	I _C =3A ; V _{CE} =4V	70		220	
f _T	Transition frequency	I _C =0.5A ; V _{CE} =12V		30		MHz
C _{OB}	Collector output capacitance	f=1MHz ; V _{CB} =10V		110		pF

Switching times

t _{on}	Turn-on time	I _C =3.0A I _{B1} =0.3A , I _{B2} =-0.6A V _{CC} =50V, R _L =16.7Ω			0.5	μs
t _s	Storage time				3.0	μs
t _f	Fall time				0.5	μs

◆ h_{FE-2} Classifications

O	Y	G
70-140	100-200	160-220

Silicon NPN Power Transistors

2SC3834

PACKAGE OUTLINE

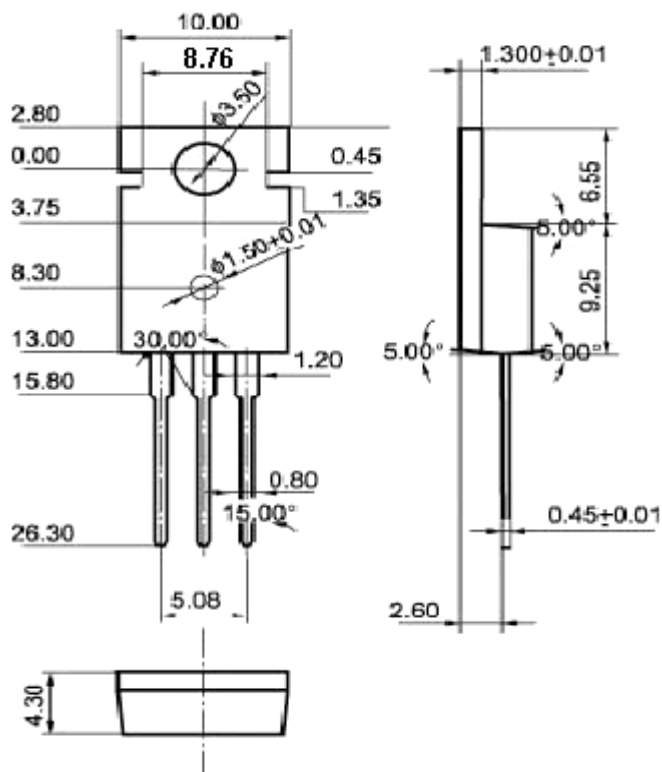

Fig.2 outline dimensions (unindicated tolerance:±0.10 mm)

Silicon NPN Power Transistors

2SC3834

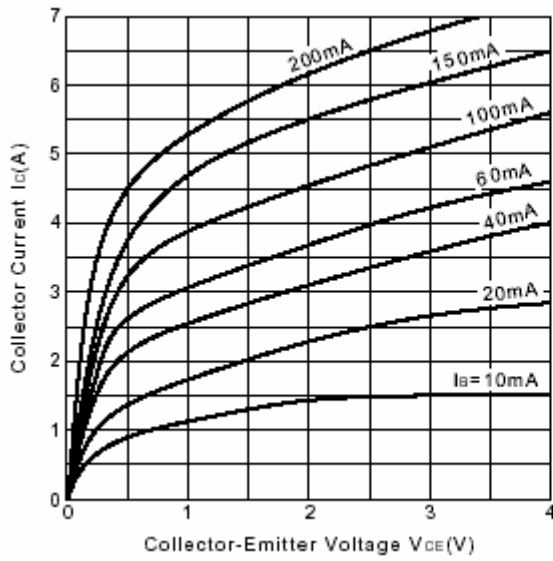

Fig.3 Static Characteristic

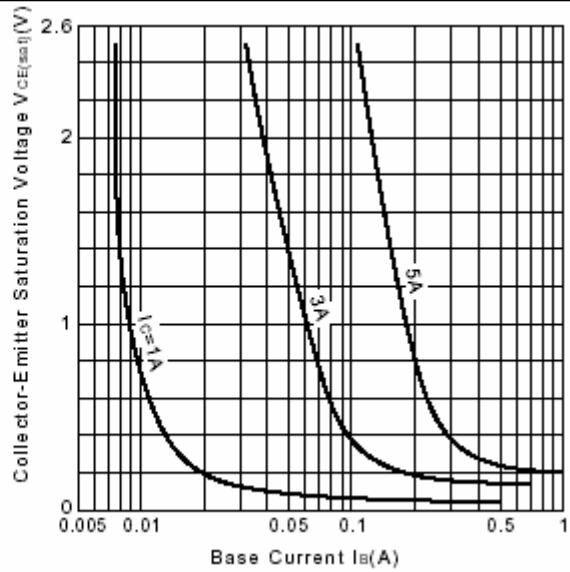

Fig.4 $V_{CE(sat)}-I_B$

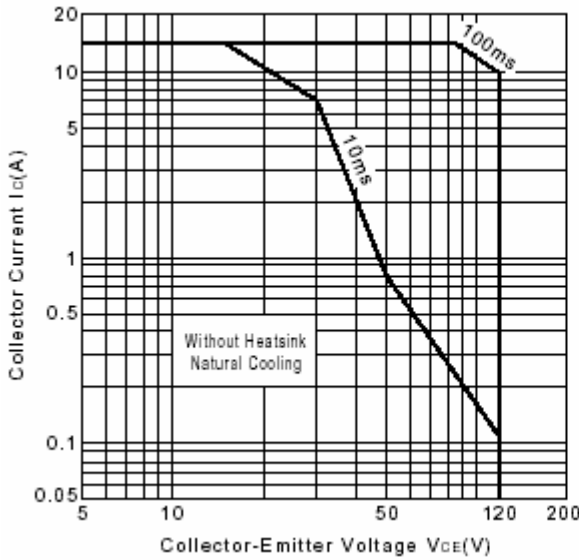

Fig.5 Safe Operating Area

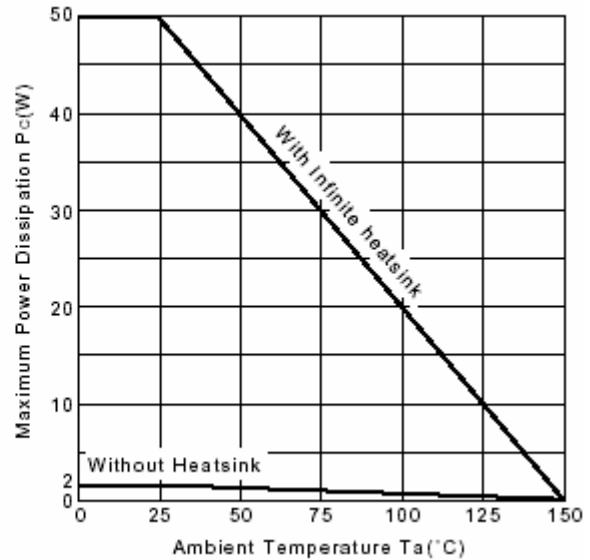

Fig.6 Power Derating

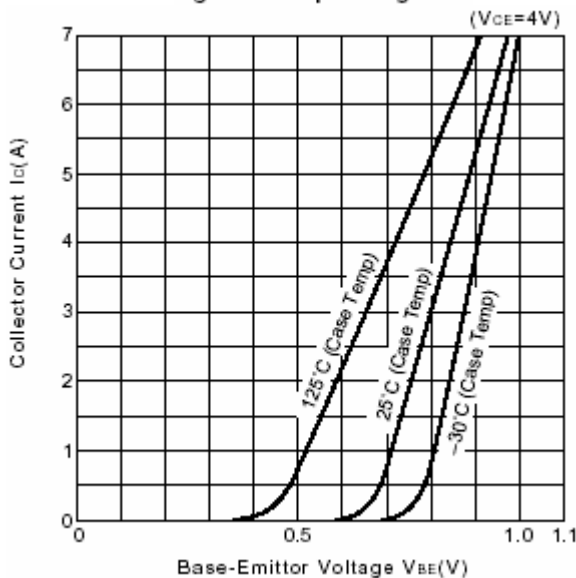

Fig.7 I_C-V_{BE}

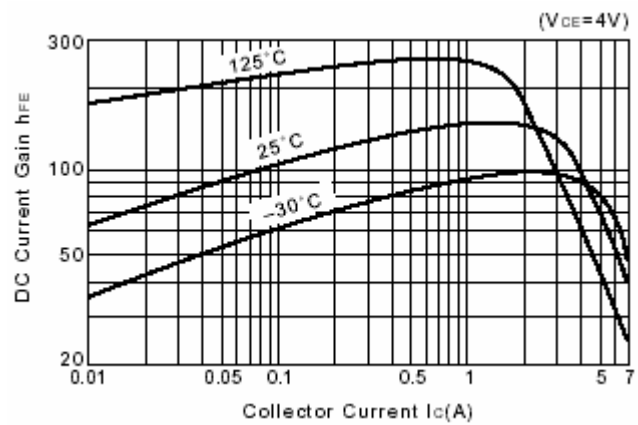

Fig.8 DC current Gain