

GPTR1300

PHASE CONTROLLED SCR

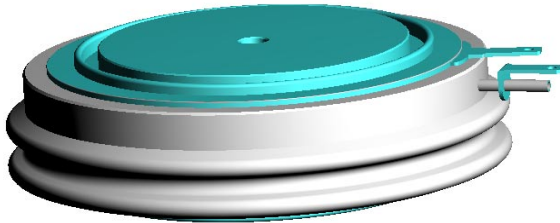

High reliability operation
DC power supply
AC drives

VOLTAGE UP TO **800 V**
AVERAGE CURRENT **3000 A**
SURGE CURRENT **30 kA**

BLOCKING CHARACTERISTICS

Characteristic	Conditions	Value
VRRM	Repetitive peak reverse voltage	800 V
VRSM	Non-repetitive peak reverse voltage	900 V
VDRM	Repetitive peak off-state voltage	800 V
IDRM	Repetitive peak off-state current, max.	VDRM, single phase, half wave, T _j = T _{jmax}
IRRM	Repetitive peak reverse current, max.	VRRM, single phase, half wave, T _j = T _{jmax}

ON-STATE CHARACTERISTICS

I _{T(AV)}	Average on-state current	Sine wave, 180° conduction, Th = 55 °C	3000 A
I _{T(RMS)}	R.M.S. on-state current	Sine wave, 180° conduction, Th = 55 °C	4712 A
I _{TSM}	Surge on-state current	Non rep. half sine wave, 50 Hz, V _R = 0 V, T _j = T _{jmax}	30 kA
I ² t	I ² t for fusing coordination		4500 kA ² s
V _{T(TO)}	Threshold voltage	T _j = T _{jmax}	1,0 V
r _T	On-state slope resistance	T _j = T _{jmax}	0,116 mΩ
V _{TM}	Peak on-state voltage, max	On-state current I _T = 6300 A , T _j = 25 °C	1,78 V
I _H	Holding current, max	T _j = 25 °C	300 mA
I _L	Latching current, typ	T _j = 25 °C	500 mA

TRIGGERING CHARACTERISTICS

V _{GT}	Gate trigger voltage	T _j = 25 °C, V _D = 5 V	3 V
I _{GT}	Gate trigger current	T _j = 25 °C, V _D = 5 V	400 mA
V _{GD}	Non-trigger voltage	V _D = 67% VRRM, T _j = T _{jmax}	0,1 V
P _{GM}	Peak gate power dissipation	Pulse width 0.5 ms	100 W
P _{G(AV)}	Average gate power dissipation		5 W
I _{FGM}	Peak gate current		30 A
V _{FGM}	Peak gate voltage (forward)		12 V
V _{RGM}	Peak gate voltage (reverse)		3 V

SWITCHING CHARACTERISTICS

di/dt	Critical rate of rise of on-state current	T _j = T _{jmax}	200 A/μs
dV/dt	Critical rate of rise of off-state voltage	T _j = T _{jmax}	500 V/μs
t _q	Turn-off time, typ	T _j = T _{jmax} , I _T = 800 A, di/dt = -12.5 A/μs V _R = 100 V, V _D = 67% VDRM, dV/dt = 20 V/μs	400 μs

THERMAL AND MECHANICAL CHARACTERISTICS

R _{th(j-c)}	Thermal resistance (junction to case)	Double side cooled	0,016 °C/W
R _{th(c-h)}	Thermal resistance (case to heatsink)	Double side cooled	0,001 °C/W
T _{jmax}	Max operating junction temperature		150 °C
T _{stg}	Storage temperature		-40 / 150 °C
F	Clamping force ± 10%		30 kN
	Mass		1400 g

Current rating - sine wave

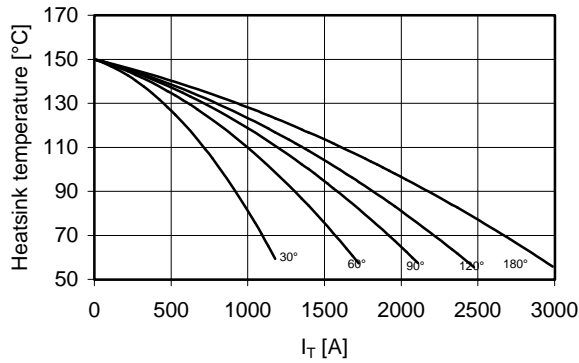

Power loss - sine wave

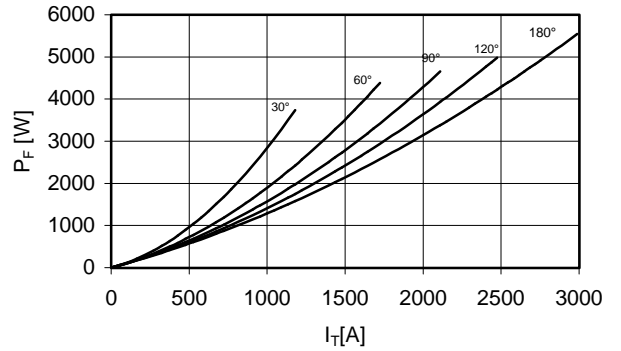

Maximum surge current d.s. cooled

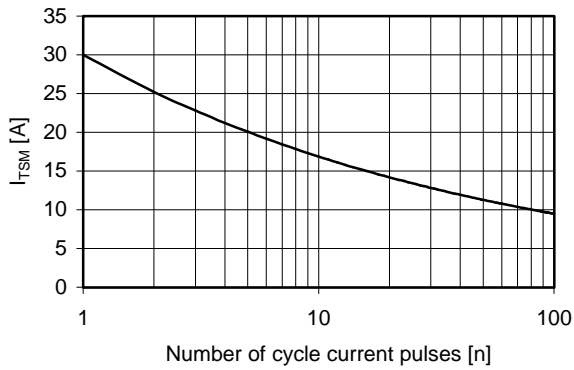

On-state voltage drop

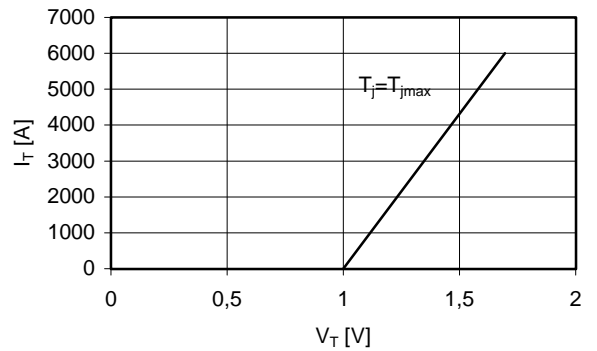

Thermal impedance (j-c)

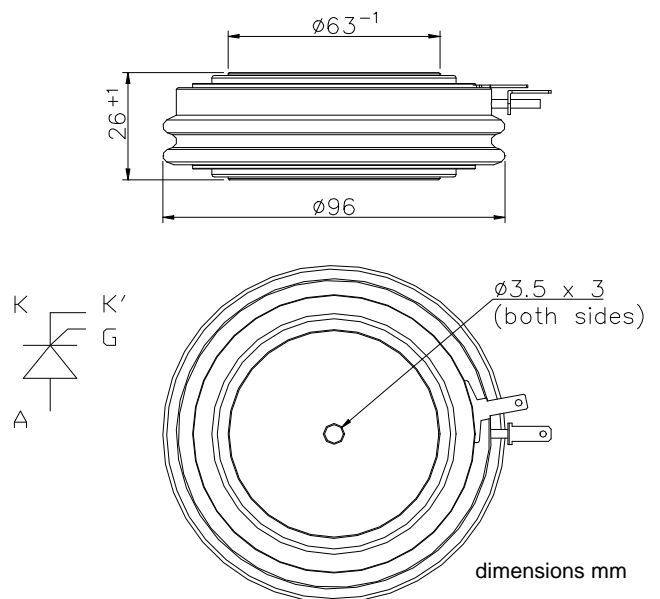
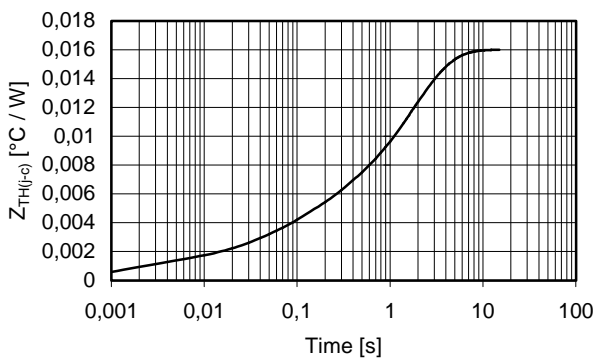

In the interest of product improvement Green Power Solutions reserves the right to change any specification given in this data sheet without notice.