



# RF Power Field Effect Transistor

## N-Channel Enhancement-Mode Lateral MOSFET

Designed primarily for wideband applications with frequencies up to 250 MHz. Device is unmatched and is suitable for use in broadcast applications.

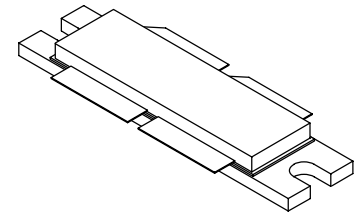
- Typical DVBT OFDM Performance:  $V_{DD} = 50$  Volts,  $I_{DQ} = 2600$  mA,  $P_{out} = 125$  Watts Avg.,  $f = 225$  MHz, Channel Bandwidth = 7.61 MHz, Input Signal PAR = 9.3 dB @ 0.01% Probability on CCDF.  
Power Gain — 25 dB  
Drain Efficiency — 28.5%  
ACPR @ 4 MHz Offset — -61 dBc @ 4 kHz Bandwidth
- Typical Pulsed Performance:  $V_{DD} = 50$  Volts,  $I_{DQ} = 2600$  mA,  $P_{out} = 600$  Watts Peak,  $f = 225$  MHz, Pulse Width = 100  $\mu$ sec, Duty Cycle = 20%  
Power Gain — 25.3 dB  
Drain Efficiency — 59%
- Capable of Handling 10:1 VSWR, @ 50 Vdc, 225 MHz, 600 Watts Peak Power, Pulse Width = 100  $\mu$ sec, Duty Cycle = 20%

### Features

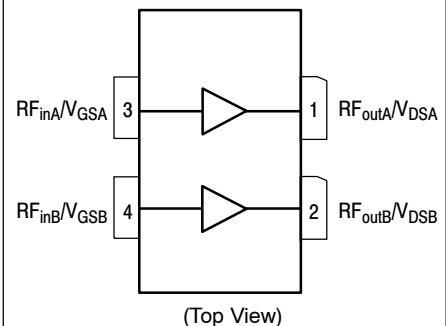
- Integrated ESD Protection
- Excellent Thermal Stability
- Designed for Push-Pull Operation
- Greater Negative Gate-Source Voltage Range for Improved Class C Operation
- RoHS Compliant
- In Tape and Reel. R6 Suffix = 150 Units per 56 mm, 13 inch Reel.

**MRF6VP2600HR6**

**10-250 MHz, 600 W, 50 V  
LATERAL N-CHANNEL  
BROADBAND  
RF POWER MOSFET**



**CASE 375D-05, STYLE 1  
NI-1230  
PART IS PUSH-PULL**



**Figure 1. Pin Connections**

**Table 1. Maximum Ratings**

Rating	Symbol	Value	Unit
Drain-Source Voltage	$V_{DSS}$	-0.5, +110	Vdc
Gate-Source Voltage	$V_{GS}$	-6.0, +10	Vdc
Storage Temperature Range	$T_{stg}$	- 65 to +150	$^{\circ}$ C
Case Operating Temperature	$T_C$	150	$^{\circ}$ C
Operating Junction Temperature	$T_J$	200	$^{\circ}$ C

**Table 2. Thermal Characteristics**

Characteristic	Symbol	Value (1,2)	Unit
Thermal Resistance, Junction to Case Case Temperature 99 $^{\circ}$ C, 125 W CW	$R_{\theta JC}$	0.20	$^{\circ}$ C/W

1. MTF calculator available at <http://www.freescale.com/rf>. Select Software & Tools/Development Tools/Calculators to access MTF calculators by product.
2. Refer to AN1955, *Thermal Measurement Methodology of RF Power Amplifiers*. Go to <http://www.freescale.com/rf>. Select Documentation/Application Notes - AN1955.

**Table 3. ESD Protection Characteristics**

Test Methodology	Class
Human Body Model (per JESD22-A114)	2 (Minimum)
Machine Model (per EIA/JESD22-A115)	A (Minimum)
Charge Device Model (per JESD22-C101)	IV (Minimum)

**Table 4. Electrical Characteristics** ( $T_C = 25^\circ\text{C}$  unless otherwise noted)

Characteristic	Symbol	Min	Typ	Max	Unit
----------------	--------	-----	-----	-----	------

**Off Characteristics** <sup>(1)</sup>

Gate-Source Leakage Current ( $V_{GS} = 5\text{ Vdc}$ , $V_{DS} = 0\text{ Vdc}$ )	$I_{GSS}$	—	—	10	$\mu\text{Adc}$
Drain-Source Breakdown Voltage ( $I_D = 150\text{ mA}$ , $V_{GS} = 0\text{ Vdc}$ )	$V_{(BR)DSS}$	110	—	—	Vdc
Zero Gate Voltage Drain Leakage Current ( $V_{DS} = 50\text{ Vdc}$ , $V_{GS} = 0\text{ Vdc}$ )	$I_{DSS}$	—	—	50	$\mu\text{Adc}$
Zero Gate Voltage Drain Leakage Current ( $V_{DS} = 100\text{ Vdc}$ , $V_{GS} = 0\text{ Vdc}$ )	$I_{DSS}$	—	—	2.5	mA

**On Characteristics**

Gate Threshold Voltage <sup>(1)</sup> ( $V_{DS} = 10\text{ Vdc}$ , $I_D = 800\ \mu\text{Adc}$ )	$V_{GS(th)}$	1	1.65	3	Vdc
Gate Quiescent Voltage <sup>(2)</sup> ( $V_{DD} = 50\text{ Vdc}$ , $I_D = 2600\text{ mAdc}$ , Measured in Functional Test)	$V_{GS(Q)}$	1.5	2.7	3.5	Vdc
Drain-Source On-Voltage <sup>(1)</sup> ( $V_{GS} = 10\text{ Vdc}$ , $I_D = 2\text{ Adc}$ )	$V_{DS(on)}$	—	0.25	—	Vdc

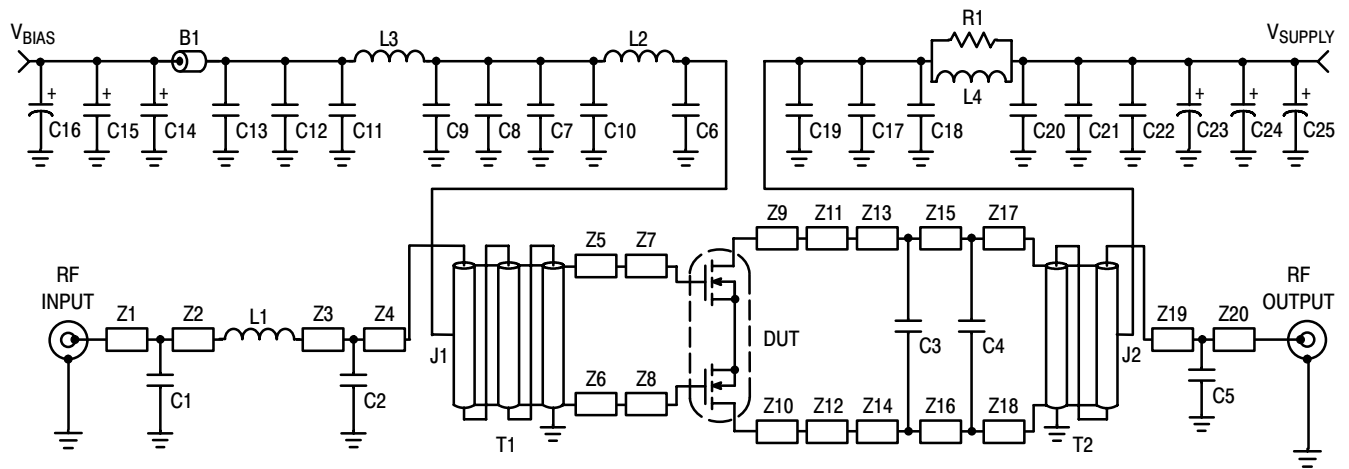
**Dynamic Characteristics** <sup>(1)</sup>

Reverse Transfer Capacitance ( $V_{DS} = 50\text{ Vdc} \pm 30\text{ mV(rms)ac}$ @ 1 MHz, $V_{GS} = 0\text{ Vdc}$ )	$C_{rss}$	—	1.7	—	pF
Output Capacitance ( $V_{DS} = 50\text{ Vdc} \pm 30\text{ mV(rms)ac}$ @ 1 MHz, $V_{GS} = 0\text{ Vdc}$ )	$C_{oss}$	—	101	—	pF
Input Capacitance ( $V_{DS} = 50\text{ Vdc}$ , $V_{GS} = 0\text{ Vdc} \pm 30\text{ mV(rms)ac}$ @ 1 MHz)	$C_{iss}$	—	287	—	pF

**Functional Tests** <sup>(2)</sup> (In Freescale Test Fixture, 50 ohm system)  $V_{DD} = 50\text{ Vdc}$ ,  $I_{DQ} = 2600\text{ mA}$ ,  $P_{out} = 125\text{ W Avg.}$ ,  $f = 225\text{ MHz}$ , DVBT OFDM Single Channel. ACPR measured in 7.61 MHz Channel Bandwidth @  $\pm 4\text{ MHz}$  Offset.

Power Gain	$G_{ps}$	24	25	27	dB
Drain Efficiency	$\eta_D$	27	28.5	—	%
Adjacent Channel Power Ratio	ACPR	—	-61	-59	dBc
Input Return Loss	IRL	—	-18	-9	dB

- Each side of device measured separately.
- Measurement made with device in push-pull configuration.



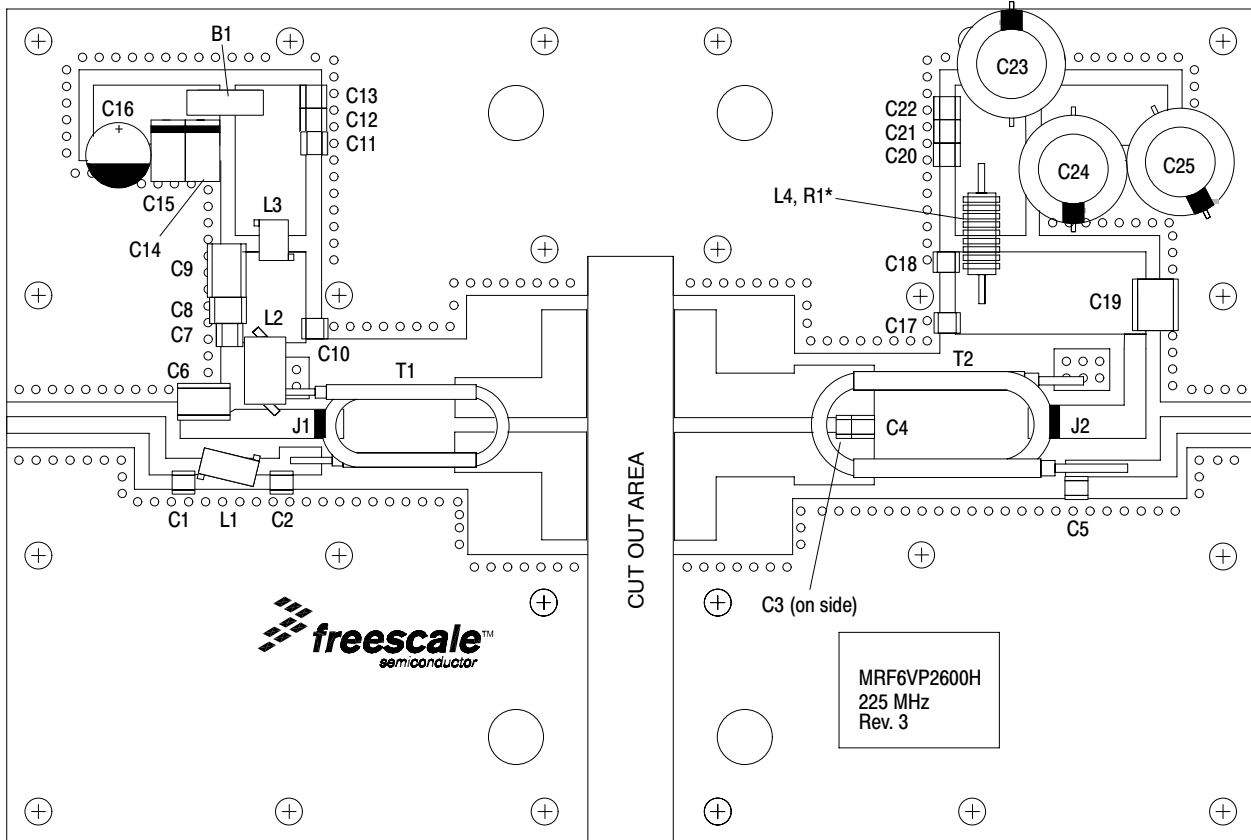
Z1	1.049" x 0.080" Microstrip	Z13, Z14	0.224" x 0.253" Microstrip
Z2*	0.143" x 0.080" Microstrip	Z15*, Z16*	0.095" x 0.253" Microstrip
Z3*	0.188" x 0.080" Microstrip	Z17, Z18	0.052" x 0.253" Microstrip
Z4	0.192" x 0.133" Microstrip	Z19	0.053" x 0.080" Microstrip
Z5, Z6	0.418" x 0.193" Microstrip	Z20	1.062" x 0.080" Microstrip
Z7, Z8	0.217" x 0.518" Microstrip	PCB	Arlon CuClad 250GX-0300-55-22, 0.030", $\epsilon_r = 2.55$
Z9, Z10	0.200" x 0.518" Microstrip		
Z11, Z12	0.375" x 0.214" Microstrip		
			* Line length includes microstrip bends

**Figure 2. MRF6VP2600HR6 Test Circuit Schematic**

**Table 5. MRF6VP2600HR6 Test Circuit Component Designations and Values**

Part	Description	Part Number	Manufacturer
B1	95 $\Omega$ , 100 MHz Long Ferrite Bead	2743021447	Fair-Rite
C1	47 pF Chip Capacitor	ATC100B470JT500XT	ATC
C2, C4	43 pF Chip Capacitors	ATC100B430JT500XT	ATC
C3	100 pF Chip Capacitor	ATC100B101JT500XT	ATC
C5	10 pF Chip Capacitor	ATC100B7R5CT500XT	ATC
C6, C9	2.2 $\mu$ F, 50 V Chip Capacitors	C1825C225J5RAC	Kemet
C7, C13, C20	10K pF Chip Capacitors	ATC200B103KT50XT	ATC
C8	220 nF, 50 V Chip Capacitor	C1812C224J5RAC	Kemet
C10, C17, C18	1000 pF Chip Capacitors	ATC100B102JT50XT	ATC
C11, C22	0.1 $\mu$ F, 50 V Chip Capacitors	CDR33BX104AKYS	Kemet
C12, C21	20K pF Chip Capacitors	ATC200B203KT50XT	ATC
C14	10 $\mu$ F, 35 V Tantalum Capacitor	T491D106K035AT	Kemet
C15	22 $\mu$ F, 35 V Tantalum Capacitor	T491X226K035AT	Kemet
C16	47 $\mu$ F, 50 V Electrolytic Capacitor	476KXM050M	Illinois Cap
C19	2.2 $\mu$ F, Chip Capacitor	2225X7R225KT3AB	ATC
C23, C24, C25	470 $\mu$ F 63V Electrolytic Capacitors	EKME630ELL471MK25S	Multicomp
J1, J2	Jumpers from PCB to T1 & T2	Copper Foil	
L1	17.5 nH 6 Turn Inductor	B06T	CoilCraft
L2	8 Turns, #20 AWG ID = 0.125" Inductor, Hand Wound	Copper Wire	
L3	82 nH Inductor	1812SMS-82NJ	CoilCraft
L4*	9 Turns, #18 AWG Inductor, Hand Wound	Copper Wire	
R1	20 $\Omega$ , 3 W Axial Leaded Resistor	5093NW20R00J	Vishay
T1	Balun	TUI-9	Comm Concepts
T2	Balun	TUO-4	Comm Concepts

\*L4 is wrapped around R1.



\*L4 is wrapped around R1.

Figure 3. MRF6VP2600HR6 Test Circuit Component Layout

## TYPICAL CHARACTERISTICS

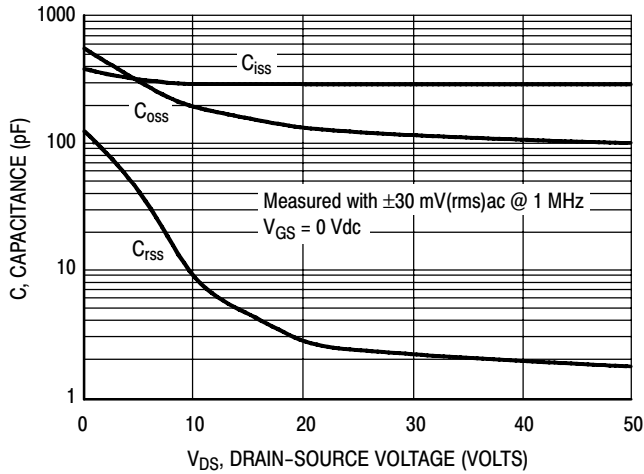


Figure 4. Capacitance versus Drain-Source Voltage

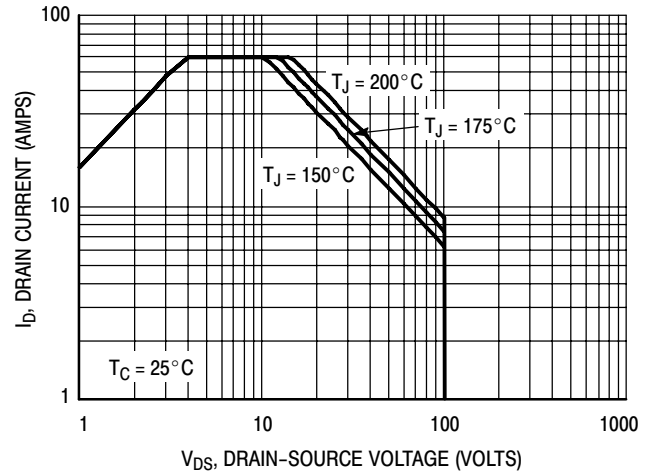


Figure 5. DC Safe Operating Area

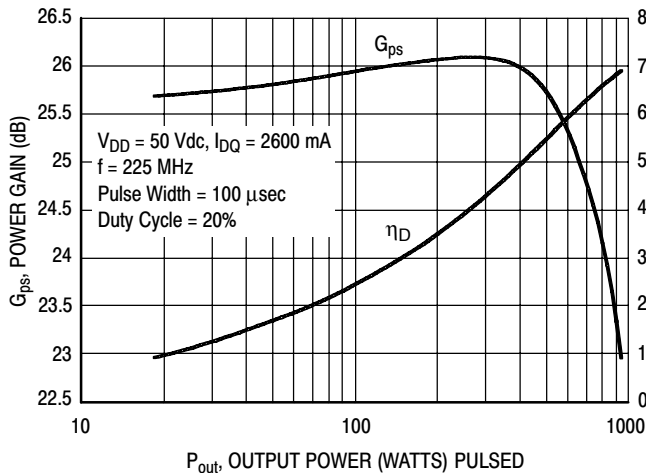


Figure 6. Pulsed Power Gain and Drain Efficiency versus Output Power

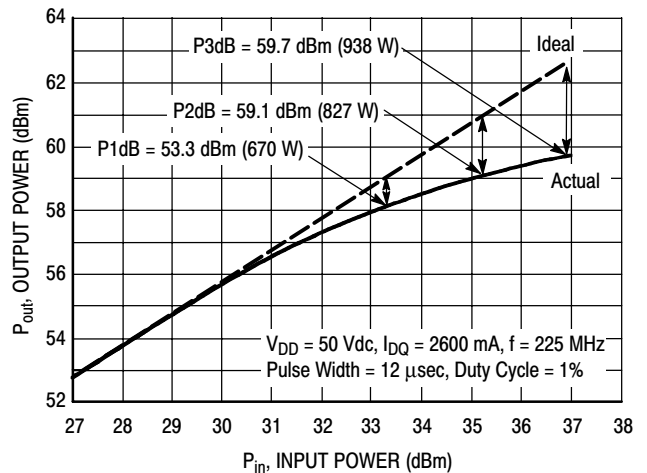


Figure 7. Pulsed CW Output Power versus Input Power

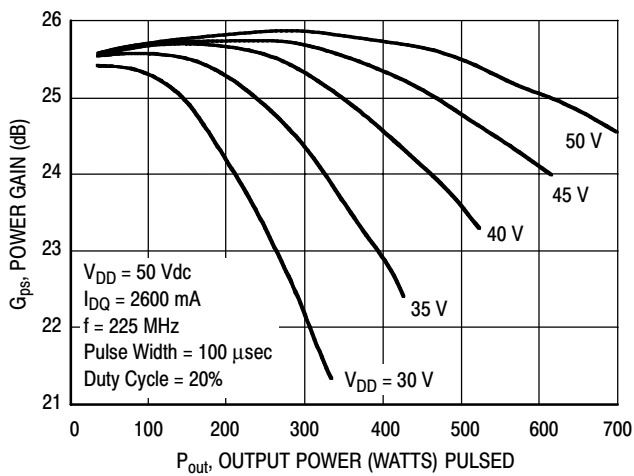


Figure 8. Pulsed Power Gain versus Output Power

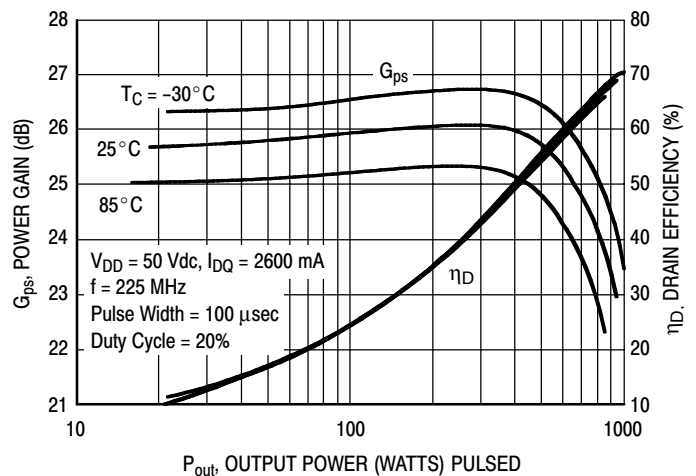
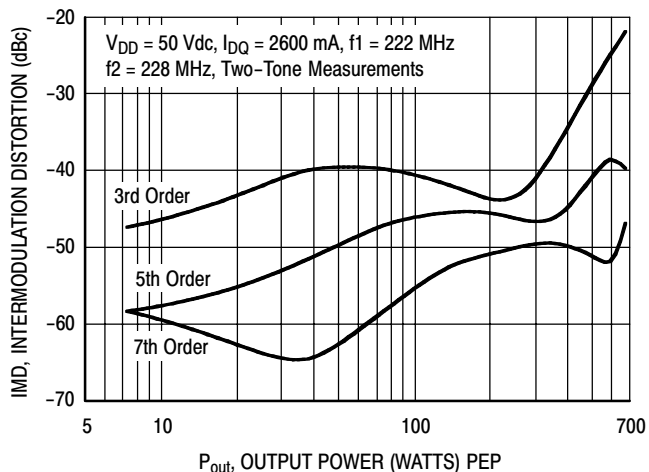
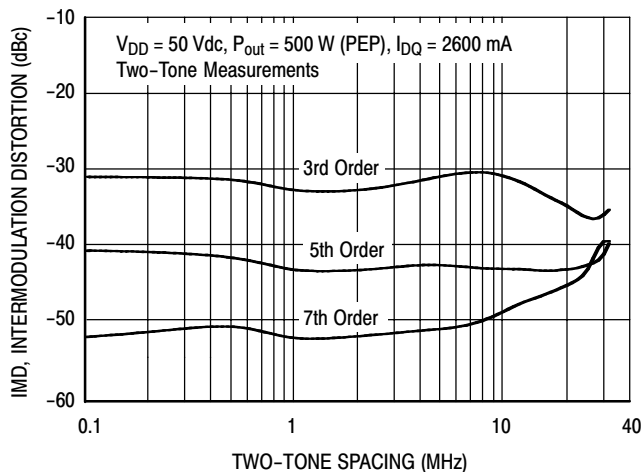


Figure 9. Pulsed Power Gain and Drain Efficiency versus Output Power

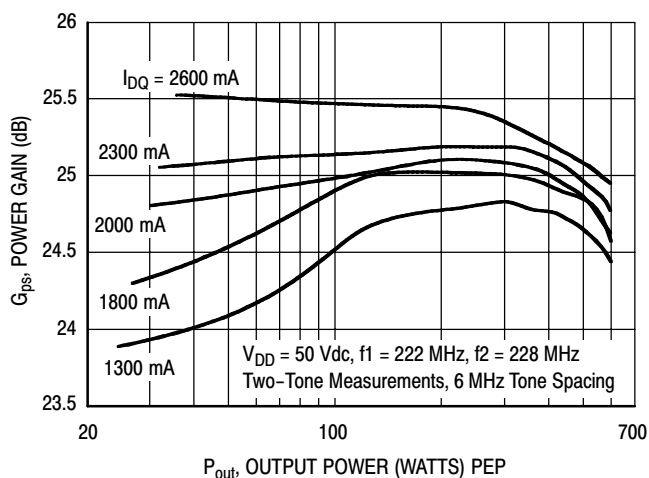
## TYPICAL CHARACTERISTICS — TWO-TONE



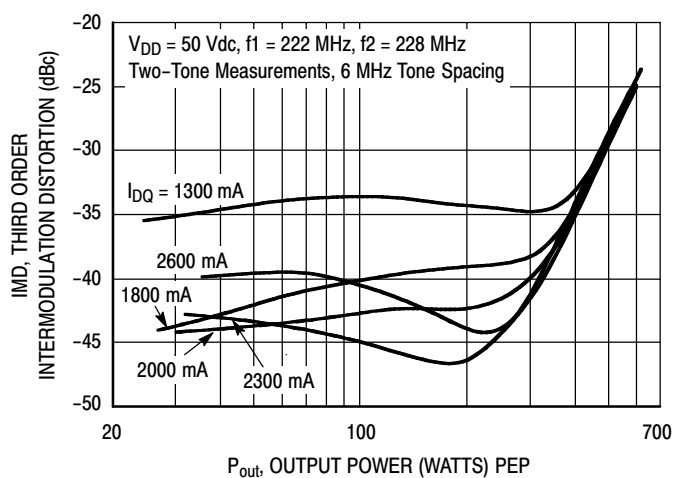
**Figure 10. Intermodulation Distortion Products versus Output Power**



**Figure 11. Intermodulation Distortion Products versus Tone Spacing**

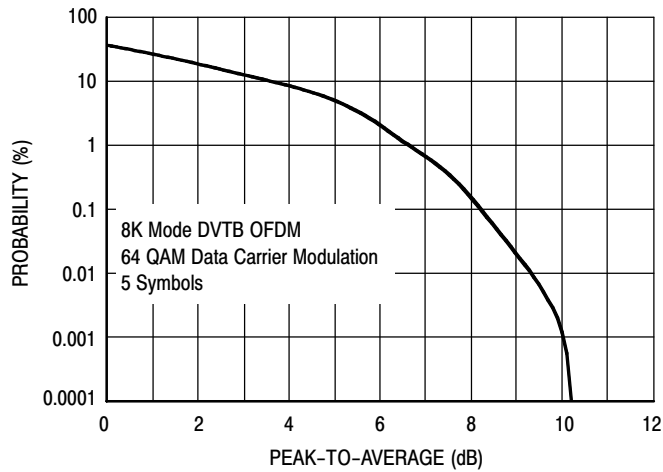


**Figure 12. Two-Tone Power Gain versus Output Power**

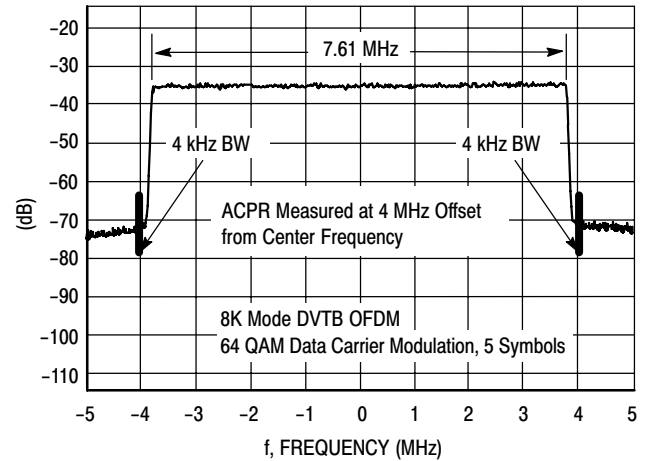


**Figure 13. Third Order Intermodulation Distortion versus Output Power**

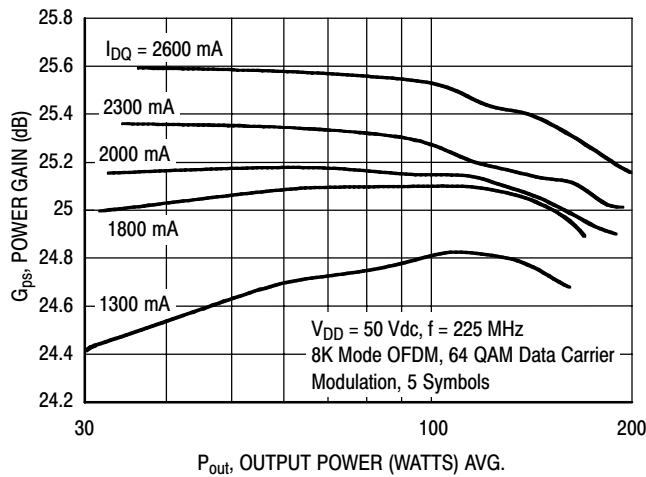
## TYPICAL CHARACTERISTICS — OFDM



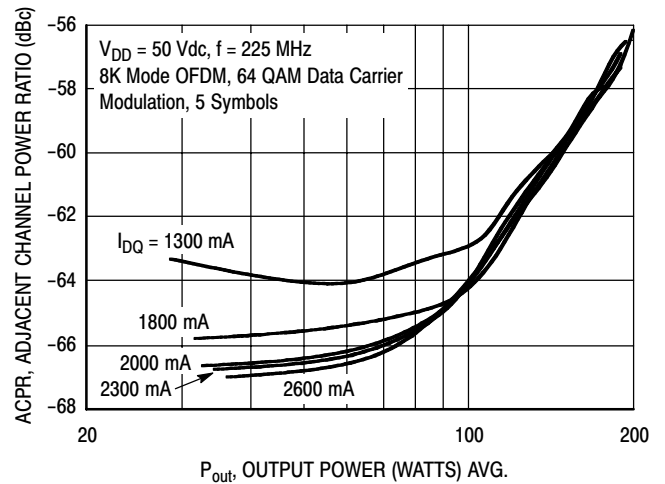
**Figure 14. Single-Carrier DVBT OFDM**



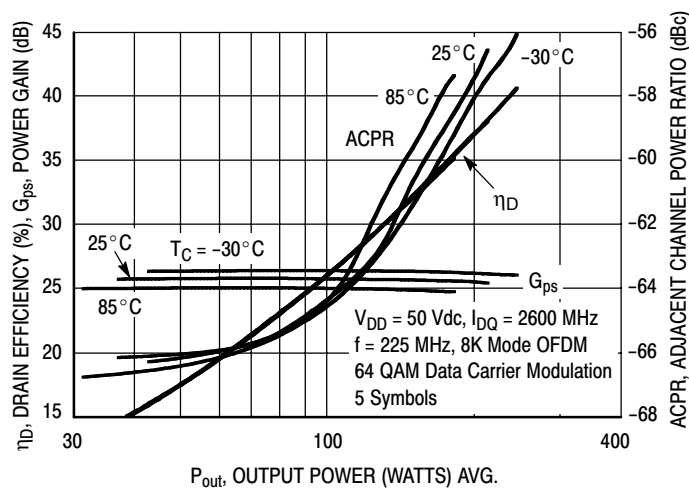
**Figure 15. 8K Mode DVBT OFDM Spectrum**



**Figure 16. Single-Carrier DVBT OFDM Power Gain versus Output Power**

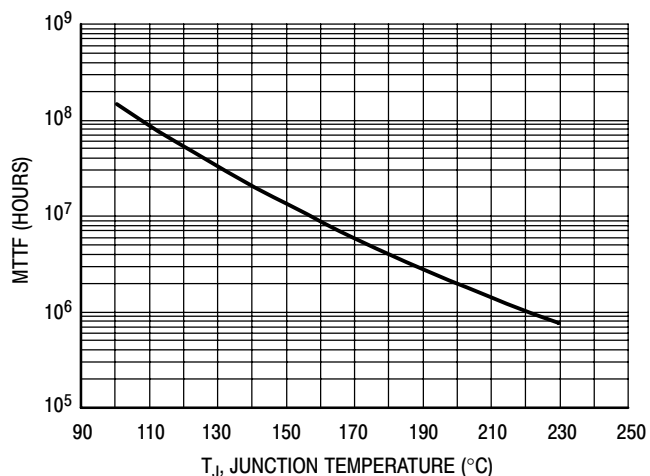


**Figure 17. Single-Carrier DVBT OFDM ACPR versus Output Power**



**Figure 18. Single-Carrier DVBT OFDM ACPR Power Gain and Drain Efficiency versus Output Power**

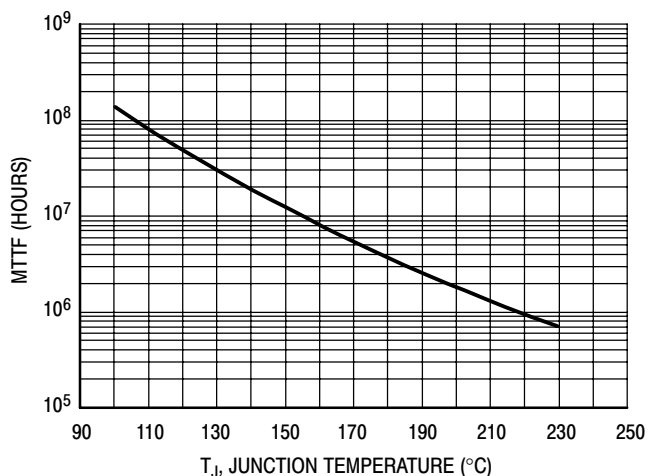
## TYPICAL CHARACTERISTICS



This above graph displays calculated MTTf in hours when the device is operated at  $V_{DD} = 50$  Vdc,  $P_{out} = 125$  W Avg., and  $\eta_D = 28.5\%$ .

MTTF calculator available at <http://www.freescale.com/rf>. Select Software & Tools/Development Tools/Calculators to access MTTf calculators by product.

**Figure 19. MTTf versus Junction Temperature - CW**

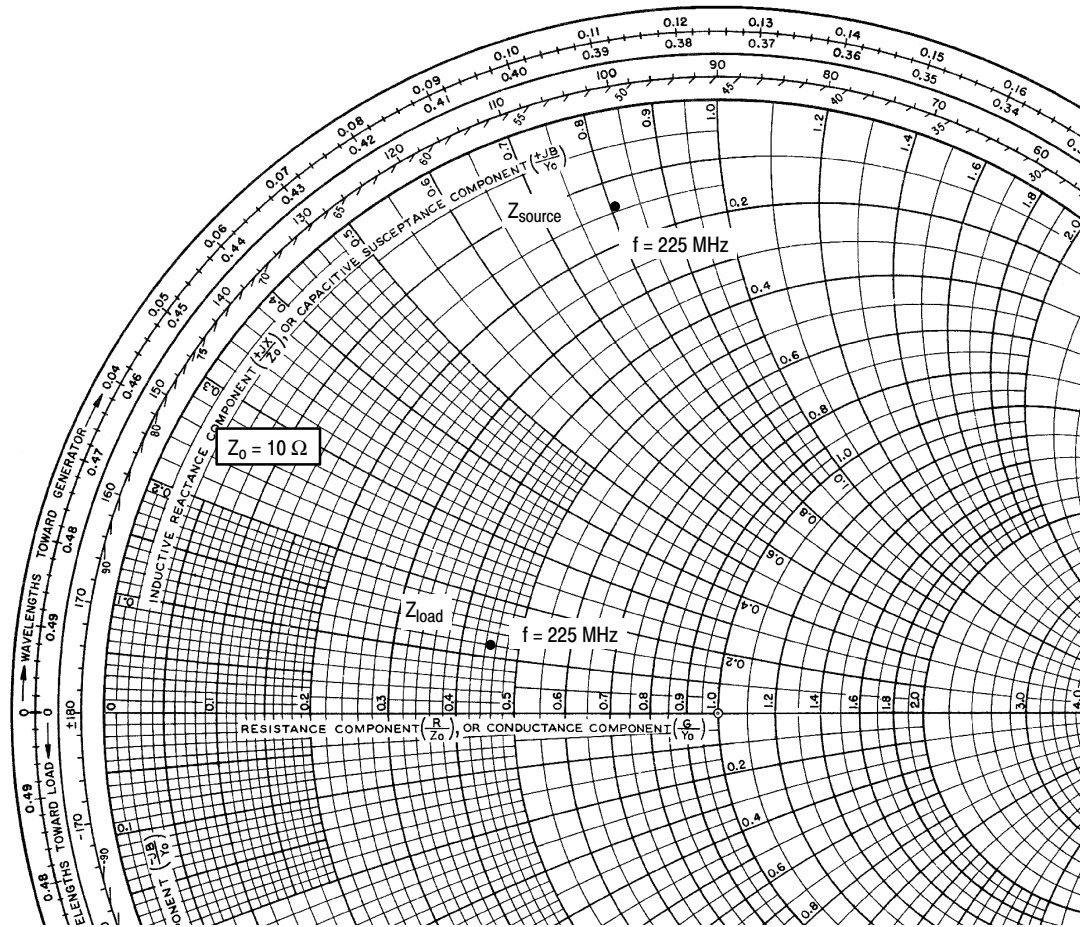


This above graph displays calculated MTTf in hours when the device is operated at  $V_{DD} = 50$  Vdc,  $P_{out} = 600$  W Peak, Pulse Width = 100  $\mu$ sec, Duty Cycle = 20%, and  $\eta_D = 59\%$ .

MTTF calculator available at <http://www.freescale.com/rf>. Select Software & Tools/Development Tools/Calculators to access MTTf calculators by product.

**Figure 20. MTTf versus Junction Temperature - Pulsed**





$V_{DD} = 50$  Vdc,  $I_{DQ} = 2600$  mA,  $P_{out} = 125$  W Avg.

f MHz	$Z_{source}$ $\Omega$	$Z_{load}$ $\Omega$
225	$1.42 + j8.09$	$4.45 + j1.16$

$Z_{source}$  = Test circuit impedance as measured from gate to ground.

$Z_{load}$  = Test circuit impedance as measured from drain to ground.

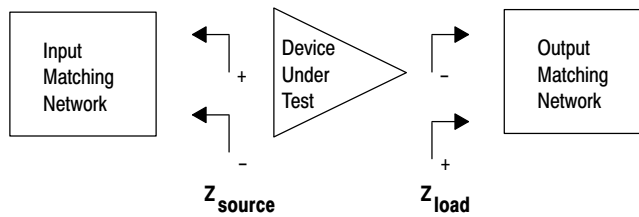
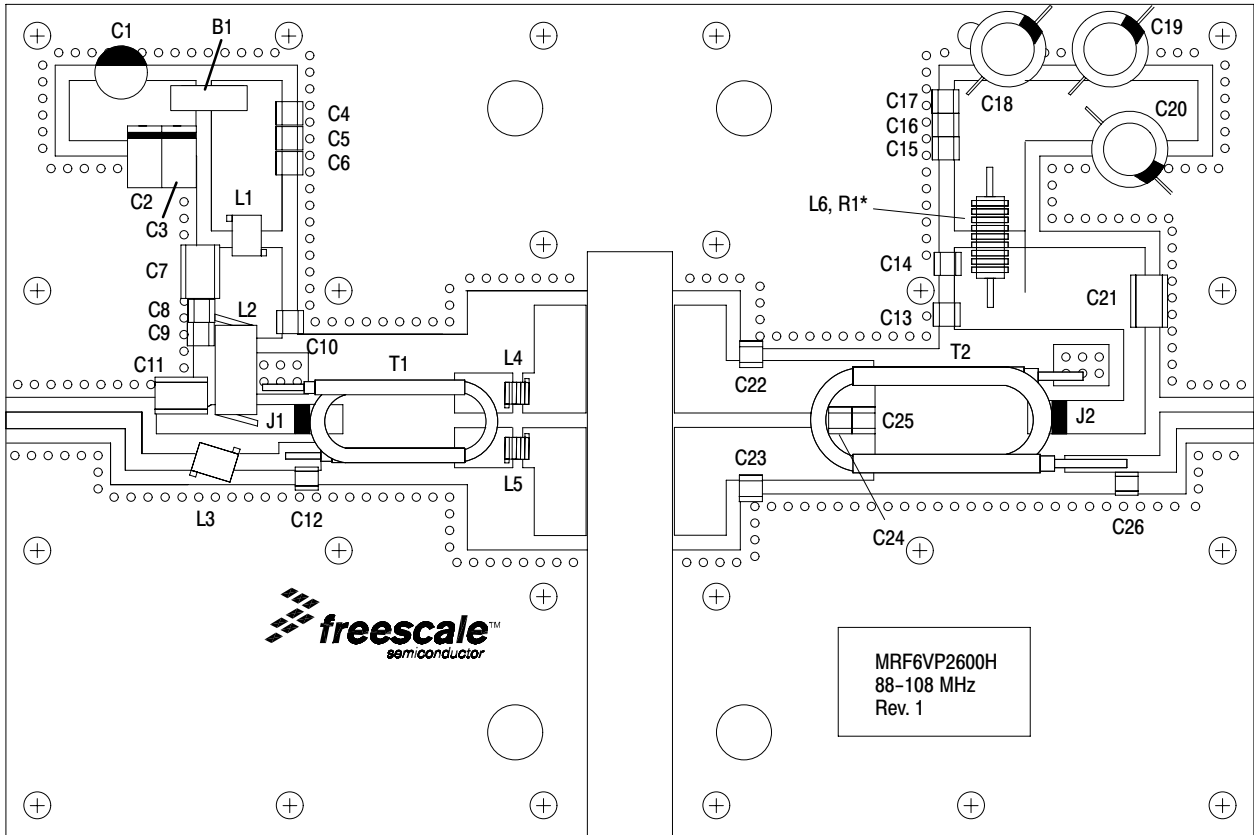


Figure 21. Series Equivalent Source and Load Impedance



\*L6 is wrapped around R1.

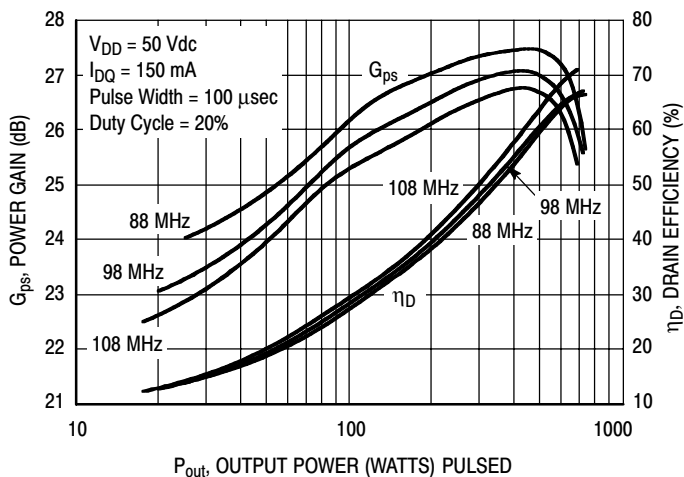
Figure 22. MRF6VP2600HR6 Test Circuit Component Layout — 88-108 MHz

**Table 6. MRF6VP2600HR6 Test Circuit Component Designations and Values — 88-108 MHz**

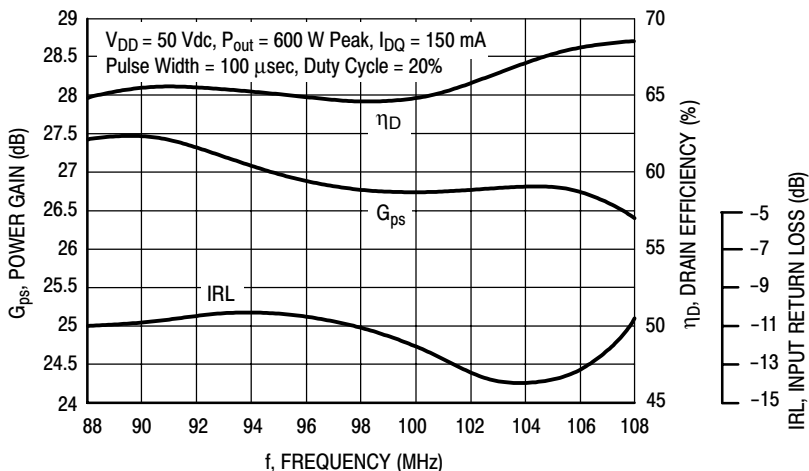
Part	Description	Part Number	Manufacturer
B1	95 $\Omega$ , 100 MHz Long Ferrite Bead	2743021447	Fair-Rite
C1	47 $\mu$ F, 50 V Electrolytic Capacitor	476KXM050M	Illinois Cap
C2	22 $\mu$ F, 35 V Tantalum Capacitor	T491X226K035AT	Kemet
C3	10 $\mu$ F, 35 V Tantalum Capacitor	T491D106K035AT	Kemet
C4, C9, C15	10K pF Chip Capacitors	ATC200B103KT50XT	ATC
C5, C16	20K pF Chip Capacitors	ATC200B203KT50XT	ATC
C6, C17	0.1 $\mu$ F, 50 V Chip Capacitors	CDR33BX104AKYS	AVX
C7, C11	2.2 $\mu$ F, 50 V Chip Capacitors	C1825C225J5RAC	Kemet
C8	220 nF, 50 V Chip Capacitor	C1812C224J5RAC	Kemet
C10, C13, C14	1000 pF Chip Capacitors	ATC100B102JT50XT	ATC
C12	33 pF Chip Capacitor	ATC100B330JT500XT	ATC
C18, C19, C20	470 $\mu$ F, 63 V Electrolytic Capacitors	EKME630ELL471MK25S	MultiComp
C21	2.2 $\mu$ F, 100 V Chip Capacitor	G2225X7R225KT3AB	ATC
C22, C23	120 pF, Chip Capacitors	ATC100B121JT500XT	ATC
C24	150 pF Chip Capacitor	ATC100B151JT500XT	ATC
C25	100 pF Chip Capacitor	ATC100B101JT500XT	ATC
C26	15 pF Chip Capacitor	ATC100B150JT500XT	ATC
J1, J2	Jumpers from PCB to T1 & T2	Copper Foil	
L1	82 nH Inductor	1812SMS-82NJ	CoilCraft
L2	8 Turns, #20 AWG ID = 0.125" Inductor, Hand Wound	Copper Wire	
L3	120 nH Inductor	1812SMS-R12J	CoilCraft
L4, L5	12.5 nH 4 Turn Inductor	A04T	CoilCraft
L6*	9 Turns, #18 AWG Inductor, Hand Wound	Copper Wire	
R1	20 $\Omega$ , 3 W Axial Leaded Resistor	5093NW20R00J	Vishay
T1	Balun Transformer	TUI-9	Comm Concepts
T2	Balun Transformer	TUO-9	Comm Concepts

\*L6 is wrapped around R1.

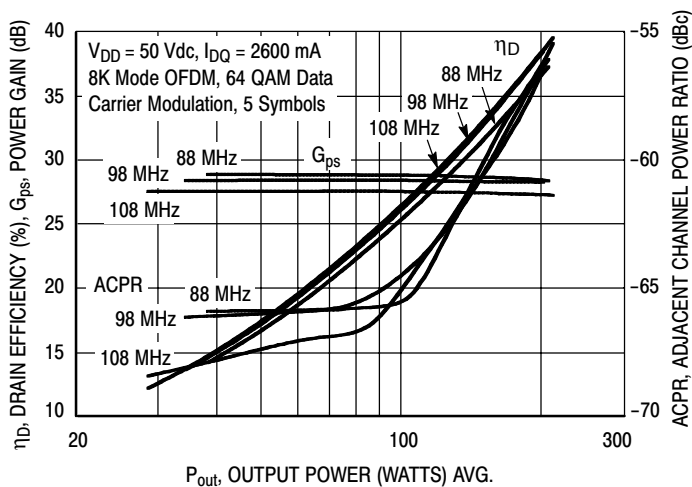
## TYPICAL CHARACTERISTICS — 88-108 MHz



**Figure 23. Broadband Pulsed Power Gain and Drain Efficiency versus Output Power — 88-108 MHz**



**Figure 24. Pulsed Power Gain, Drain Efficiency and IRL versus Frequency — 88-108 MHz**



**Figure 25. Single-Carrier DVBT OFDM ACPR, Power Gain and Drain Efficiency versus Output Power — 88-108 MHz**

TYPICAL CHARACTERISTICS — 88-108 MHz

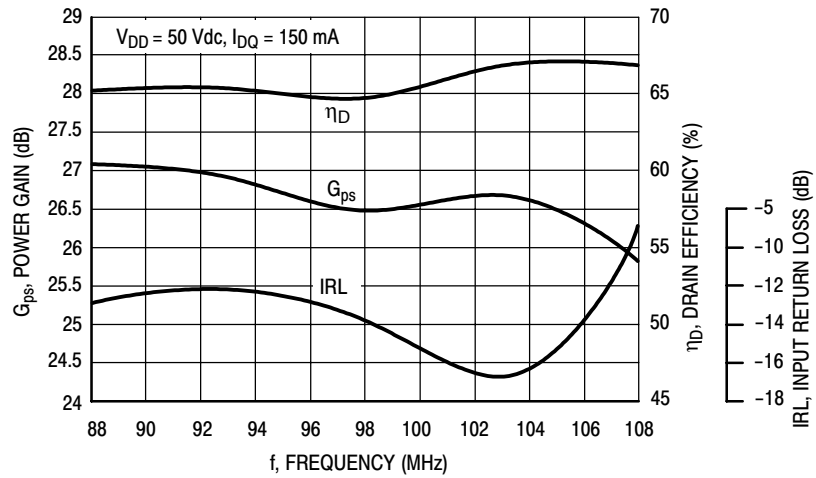
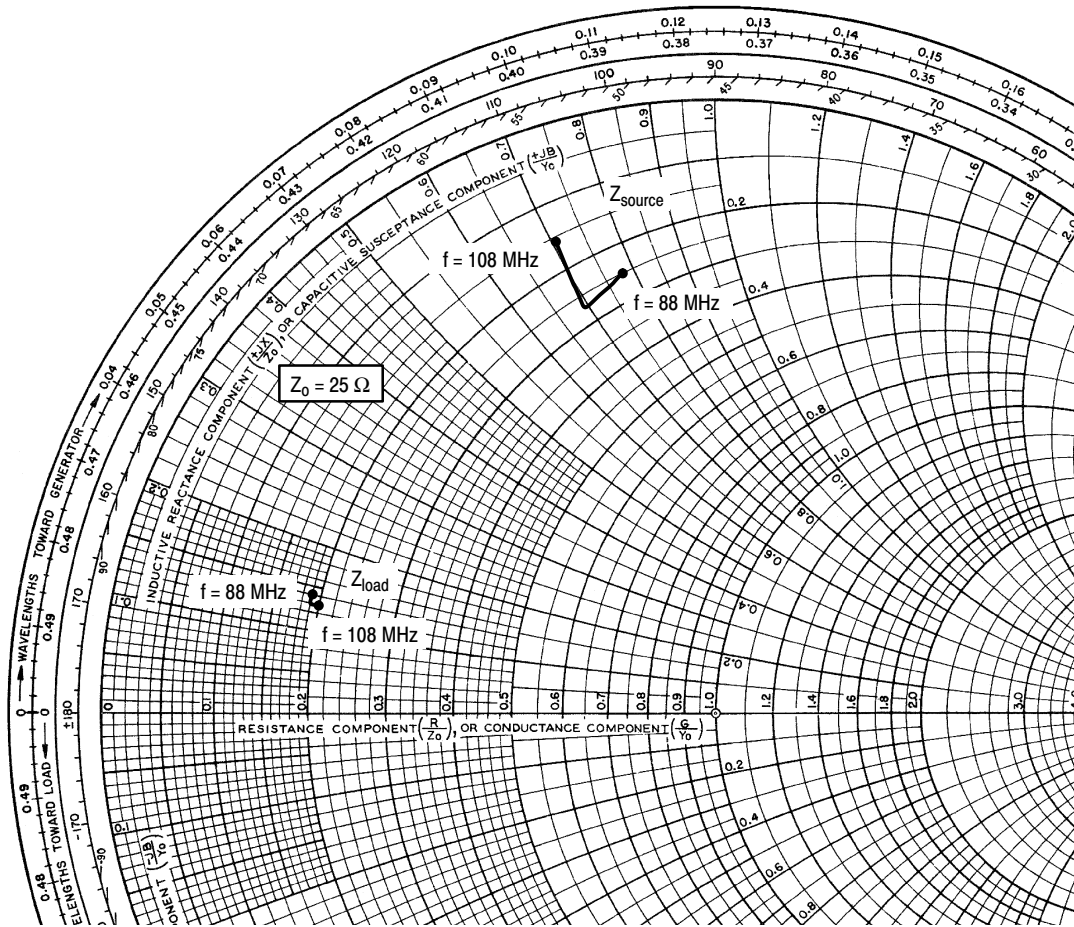


Figure 26. CW Power Gain, Drain Efficiency and IRL versus Frequency — 88-108 MHz



$V_{DD} = 50 \text{ Vdc}$ ,  $I_{DQ} = 2600 \text{ mA}$ ,  $P_{out} = 125 \text{ W Avg.}$

f MHz	$Z_{source}$ $\Omega$	$Z_{load}$ $\Omega$
88	$6.3 + j19.4$	$4.75 + j3.45$
98	$6.8 + j17.2$	$4.82 + j3.22$
108	$4.0 + j17.8$	$4.96 + j3.18$

$Z_{source}$  = Test circuit impedance as measured from gate to ground.

$Z_{load}$  = Test circuit impedance as measured from drain to ground.

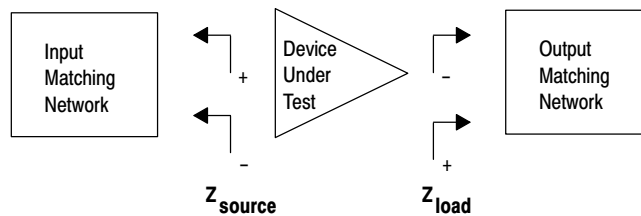
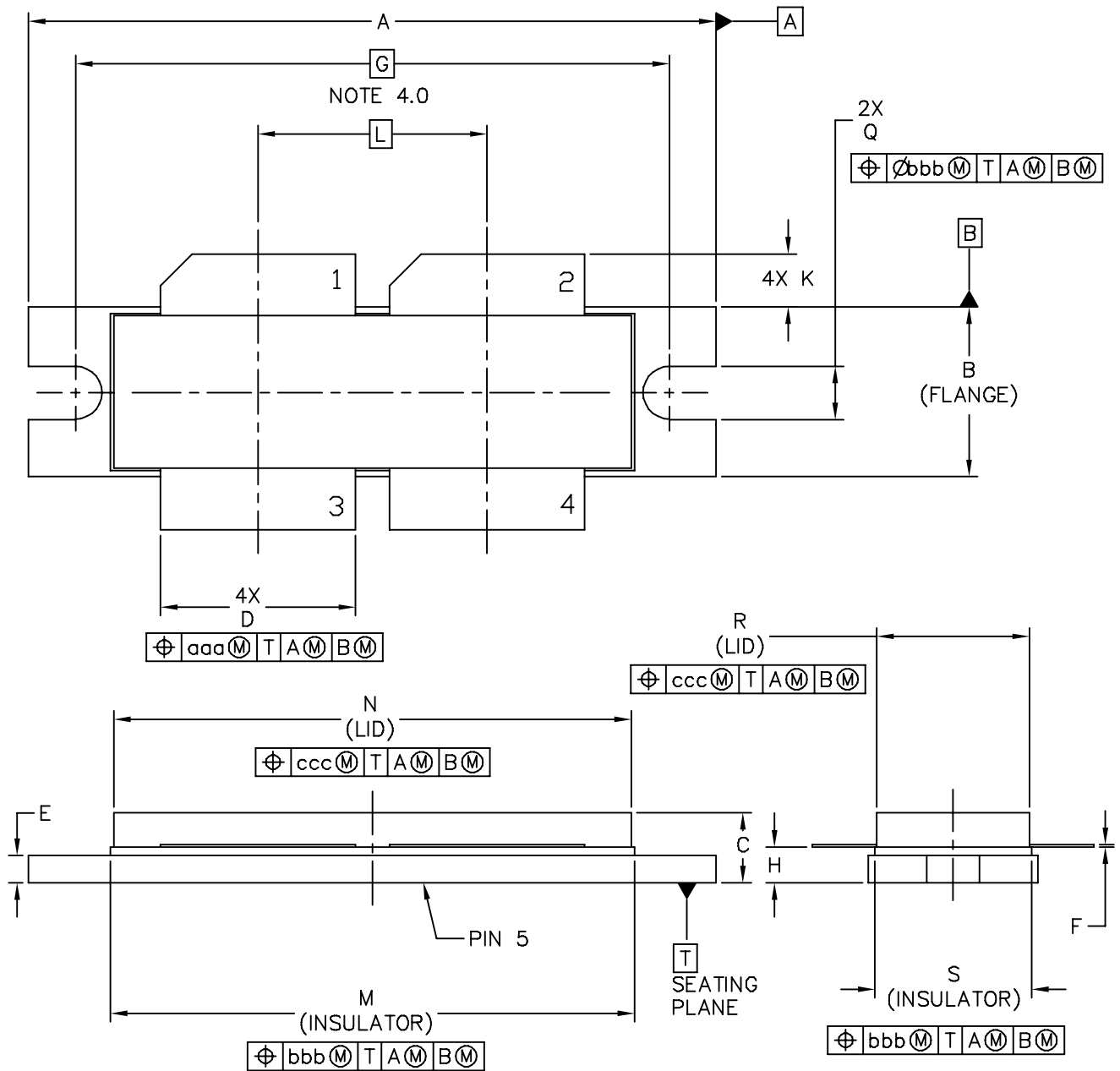


Figure 27. Series Equivalent Source and Load Impedance — 88-108 MHz

PACKAGE DIMENSIONS



<p>© FREESCALE SEMICONDUCTOR, INC. ALL RIGHTS RESERVED.</p>	<p><b>MECHANICAL OUTLINE</b></p>	<p>PRINT VERSION NOT TO SCALE</p>	
<p>TITLE:  NI-1230</p>	<p>DOCUMENT NO: 98ASB16977C</p>	<p>REV: E</p>	
	<p>CASE NUMBER: 375D-05</p>	<p>31 MAR 2005</p>	
	<p>STANDARD: NON-JEDEC</p>		

NOTES:

- 1.0 INTERPRET DIMENSIONS AND TOLERANCES PER ASME Y14.5M-1994.
- 2.0 CONTROLLING DIMENSION: INCH
- 3.0 DIMENSION H IS MEASURED .030 (0.762) AWAY FROM PACKAGE BODY.
- 4.0 RECOMMENDED BOLT CENTER DIMENSION OF 1.52 (38.61) BASED ON M3 SCREW.

STYLE 1:

- PIN 1 - DRAIN
- 2 - DRAIN
- 3 - GATE
- 4 - GATE
- 5 - SOURCE

DIM	INCH		MILLIMETER		DIM	INCH		MILLIMETER	
	MIN	MAX	MIN	MAX		MIN	MAX	MIN	MAX
A	1.615	1.625	41.02	41.28	N	1.218	1.242	30.94	31.55
B	.395	.405	10.03	10.29	Q	.120	.130	3.05	3.3
C	.150	.200	3.81	5.08	R	.355	.365	9.01	9.27
D	.455	.465	11.56	11.81	S	.365	.375	9.27	9.53
E	.062	.066	1.57	1.68					
F	.004	.007	0.1	0.18					
G	1.400 BSC		35.56 BSC		aaa	.013		0.33	
H	.082	.090	2.08	2.29	bbb	.010		0.25	
K	.117	.137	2.97	3.48	ccc	.020		0.51	
L	.540 BSC		13.72 BSC						
M	1.219	1.241	30.96	31.52					
© FREESCALE SEMICONDUCTOR, INC. ALL RIGHTS RESERVED.			<b>MECHANICAL OUTLINE</b>			PRINT VERSION NOT TO SCALE			
TITLE:  NI-1230					DOCUMENT NO: 98ASB16977C			REV: E	
					CASE NUMBER: 375D-05			31 MAR 2005	
					STANDARD: NON-JEDEC				



## PRODUCT DOCUMENTATION

Refer to the following documents to aid your design process.

### Application Notes

- AN1955: Thermal Measurement Methodology of RF Power Amplifiers

### Engineering Bulletins

- EB212: Using Data Sheet Impedances for RF LDMOS Devices

## REVISION HISTORY

The following table summarizes revisions to this document.

Revision	Date	Description
0	Mar. 2008	<ul style="list-style-type: none"><li>• Initial Release of Data Sheet</li></ul>
1	July 2008	<ul style="list-style-type: none"><li>• Removed Capable of Handling 5:1 VSWR bullet, p. 1</li><li>• Corrected <math>Z_{\text{source}}</math> and <math>Z_{\text{load}}</math> values from <math>1.58 + j6.47</math> to <math>1.42 + j8.09</math> and <math>4.60 + j1.85</math> to <math>4.45 + j1.16</math> and replotted data in Fig. 21, Series Equivalent Source and Load Impedance, p. 9</li></ul>

## **How to Reach Us:**

### **Home Page:**

[www.freescale.com](http://www.freescale.com)

### **Web Support:**

<http://www.freescale.com/support>

### **USA/Europe or Locations Not Listed:**

Freescale Semiconductor, Inc.  
Technical Information Center, EL516  
2100 East Elliot Road  
Tempe, Arizona 85284  
1-800-521-6274 or +1-480-768-2130  
[www.freescale.com/support](http://www.freescale.com/support)

### **Europe, Middle East, and Africa:**

Freescale Halbleiter Deutschland GmbH  
Technical Information Center  
Schatzbogen 7  
81829 Muenchen, Germany  
+44 1296 380 456 (English)  
+46 8 52200080 (English)  
+49 89 92103 559 (German)  
+33 1 69 35 48 48 (French)  
[www.freescale.com/support](http://www.freescale.com/support)

### **Japan:**

Freescale Semiconductor Japan Ltd.  
Headquarters  
ARCO Tower 15F  
1-8-1, Shimo-Meguro, Meguro-ku,  
Tokyo 153-0064  
Japan  
0120 191014 or +81 3 5437 9125  
[support.japan@freescale.com](mailto:support.japan@freescale.com)

### **Asia/Pacific:**

Freescale Semiconductor China Ltd.  
Exchange Building 23F  
No. 118 Jianguo Road  
Chaoyang District  
Beijing 100022  
China  
+86 10 5879 8000  
[support.asia@freescale.com](mailto:support.asia@freescale.com)

### **For Literature Requests Only:**

Freescale Semiconductor Literature Distribution Center  
P.O. Box 5405  
Denver, Colorado 80217  
1-800-441-2447 or +1-303-675-2140  
Fax: +1-303-675-2150  
[LDCForFreescaleSemiconductor@hibbertgroup.com](mailto:LDCForFreescaleSemiconductor@hibbertgroup.com)

Information in this document is provided solely to enable system and software implementers to use Freescale Semiconductor products. There are no express or implied copyright licenses granted hereunder to design or fabricate any integrated circuits or integrated circuits based on the information in this document.

Freescale Semiconductor reserves the right to make changes without further notice to any products herein. Freescale Semiconductor makes no warranty, representation or guarantee regarding the suitability of its products for any particular purpose, nor does Freescale Semiconductor assume any liability arising out of the application or use of any product or circuit, and specifically disclaims any and all liability, including without limitation consequential or incidental damages. "Typical" parameters that may be provided in Freescale Semiconductor data sheets and/or specifications can and do vary in different applications and actual performance may vary over time. All operating parameters, including "Typicals", must be validated for each customer application by customer's technical experts. Freescale Semiconductor does not convey any license under its patent rights nor the rights of others. Freescale Semiconductor products are not designed, intended, or authorized for use as components in systems intended for surgical implant into the body, or other applications intended to support or sustain life, or for any other application in which the failure of the Freescale Semiconductor product could create a situation where personal injury or death may occur. Should Buyer purchase or use Freescale Semiconductor products for any such unintended or unauthorized application, Buyer shall indemnify and hold Freescale Semiconductor and its officers, employees, subsidiaries, affiliates, and distributors harmless against all claims, costs, damages, and expenses, and reasonable attorney fees arising out of, directly or indirectly, any claim of personal injury or death associated with such unintended or unauthorized use, even if such claim alleges that Freescale Semiconductor was negligent regarding the design or manufacture of the part.

Freescale™ and the Freescale logo are trademarks of Freescale Semiconductor, Inc. All other product or service names are the property of their respective owners.

© Freescale Semiconductor, Inc. 2008. All rights reserved.

