

UNCONTROLLED DOCUMENT

PART NUMBER
SML-LX2723SIC-TR

REV.
A

REV.	E.C.N. NUMBER AND REVISION COMMENTS	DATE
A	E.C.N. #11459.	12.07.07

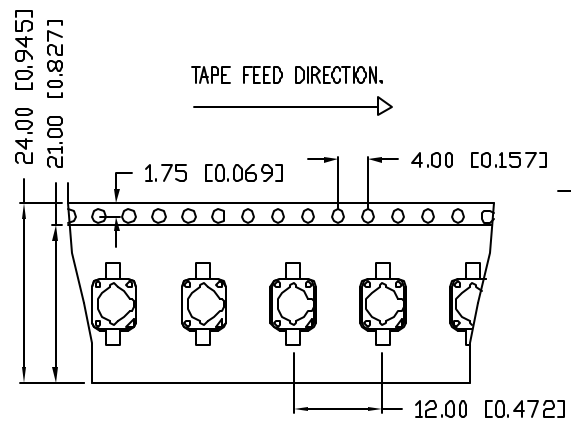
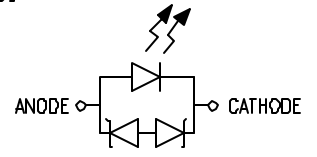
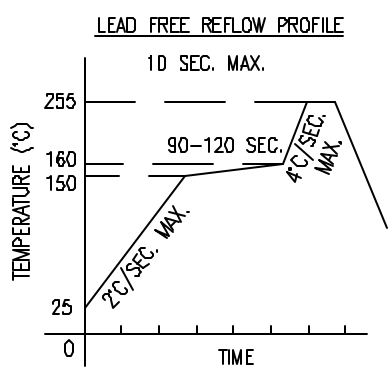
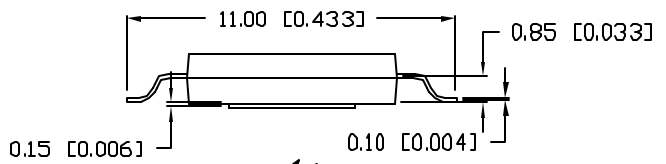
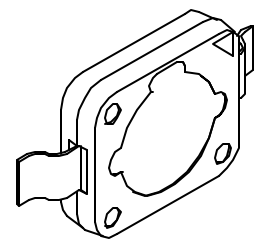
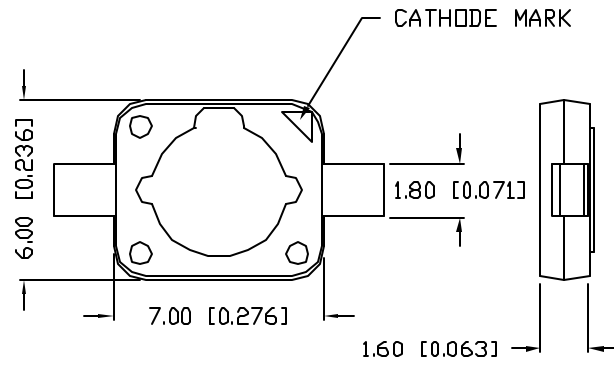

TOTAL TIME ABOVE 220°C IS 60 SECONDS MAX.

NOTE:
250 PECS PER REEL

ELECTRO-OPTICAL CHARACTERISTICS $T_A=25^\circ\text{C}$

PARAMETER	SYMBOL	MIN	TYP	MAX	UNITS	TEST COND
PEAK WAVELENGTH			630		nm	
FORWARD VOLTAGE	V_f		2.0	2.9	V	$I_f=350\text{mA}$
REVERSE VOLTAGE	V_r	5			V	$I_r=10\mu\text{A}$
AXIAL INTENSITY	I_v	23		39	lm	$I_f=350\text{mA}$
VIEWING ANGLE			120		2x theta	
EMITTED COLOR:					RED	
EPOXY LENS FINISH:					CLEAR	

LIMITS OF SAFE OPERATION AT 25°C

PARAMETER	MAX	UNITS
PEAK FORWARD CURRENT*	500	mA
STEADY CURRENT	350	mA
POWER DISSIPATION	1.5	W
DERATE FROM 25°C	-1.2	mW/°C
OPERATING, STORAGE TEMP.	-40 TO +85	°C

* $T < 10\mu\text{s}$

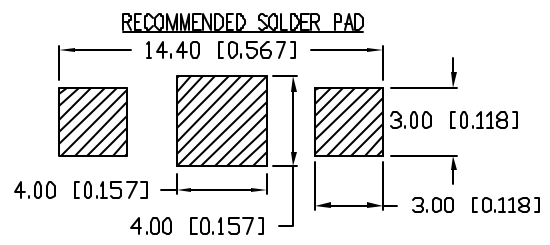

UNCONTROLLED DOCUMENT

*UNLESS OTHERWISE SPECIFIED TOLERANCES PER DECIMAL PRECISION ARE: X=±1 (±0.039), XX=±0.5 (±0.020), XXX=±0.25 (±0.010), XXXX=±0.127 (±0.005). LEAD SIZE=±0.05 (±0.002), LEAD LENGTH=±0.75 (±0.030). MIN.=+DECIMAL PRECISION-0.00 MAX.=+0.00-DECIMAL PRECISION

REV.	PART NUMBER
A	SML-LX2723SIC-TR

7mm X 6mm SURFACE MOUNT HIGH POWER LED,
630nm SUPER RED, TAPE AND REEL.

CONFIDENTIAL INFORMATION
THE INFORMATION CONTAINED IN THIS DOCUMENT IS THE PROPERTY OF LUMEX INC. EXCEPT AS SPECIFICALLY AUTHORIZED IN WRITING BY LUMEX INC., THE HOLDER OF THIS DOCUMENT SHALL KEEP ALL INFORMATION CONTAINED HEREIN CONFIDENTIAL AND SHALL PROTECT SAME IN WHOLE OR IN PART FROM DISCLOSURE AND DISSEMINATION TO ALL THIRD PARTIES.

RELIABILITY NOTE
OUR MANY YEARS OF EXPERIENCE DATA ACCUMULATION INDICATE THAT SOLDER HEAT IS A MAJOR CAUSE OF EARLY AND FUTURE FAILURE. PLEASE PAY ATTENTION TO YOUR SOLDERING PROCESS.

290 E. HELEN ROAD
PALATINE, IL 60067-6976
PHONE: +1.847.359.2790
US WEB: www.lumex.com
TW WEB: www.lumex.com.tw

DRAWN BY: JN	CHECKED BY:	APPROVED BY:	DATE: 9.04.07
			PAGE: 1 OF 1
			SCALE: N/A