

Silicon NPN Power Transistors

2SC3619

DESCRIPTION

- With TO-126 package
- High voltage
- Small collector output capacitance

APPLICATIONS

- High voltage switching and amplifier
- Color TV horizontal driver applications
- Color TV chroma output applications

PINNING

PIN	DESCRIPTION
1	Emitter
2	Collector;connected to mounting base
3	Base

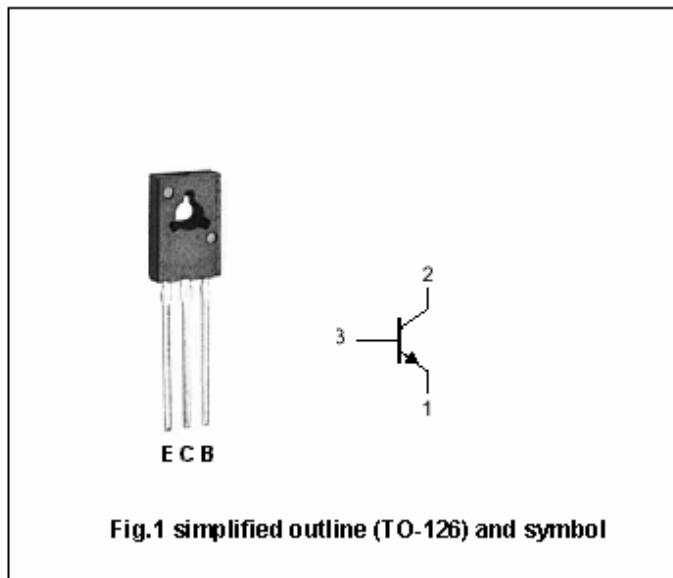

Absolute maximum ratings(Ta=25°C)

SYMBOL	PARAMETER	CONDITIONS	VALUE	UNIT
V _{CB0}	Collector-base voltage	Open emitter	300	V
V _{CEO}	Collector- emitter voltage	Open base	300	V
V _{EBO}	Emitter-base voltage	Open collector	7	V
I _C	Collector current		0.1	A
I _B	Base current		50	mA
P _C	Collector power dissipation	T _C =25°C	1.5	W
T _j	Junction temperature		150	°C
T _{stg}	Storage temperature		-55°C+150	°C

Silicon NPN Power Transistors

2SC3619

CHARACTERISTICS

T_j=25°C unless otherwise specified

SYMBOL	PARAMETER	CONDITIONS	MIN	TYP.	MAX	UNIT
I _{CB0}	Collector cutoff current	V _{CB} =240V; I _E =0			0.1	μA
I _{EB0}	Emitter cutoff current	V _{EB} =7V; I _C =0			0.1	μA
V _{CEsat}	Collector-emitter saturation voltage	I _C =10mA ; I _B =1mA			1	V
V _{BEsat}	Base-emitter saturation voltage	I _C =10mA ; I _B =1mA			1	V
h _{FE-1}	DC current gain	I _C =4mA ; V _{CE} =10V	20			
h _{FE-2}	DC current gain	I _C =20mA ; V _{CE} =10V	30		200	
C _{Ob}	Output capacitance	I _E =0; V _{CB} =20V; f=1MHz		3		pF
f _T	Transition frequency	I _C =20mA ; V _{CE} =10V,	50			MHz

Silicon NPN Power Transistors

2SC3619

PACKAGE OUTLINE

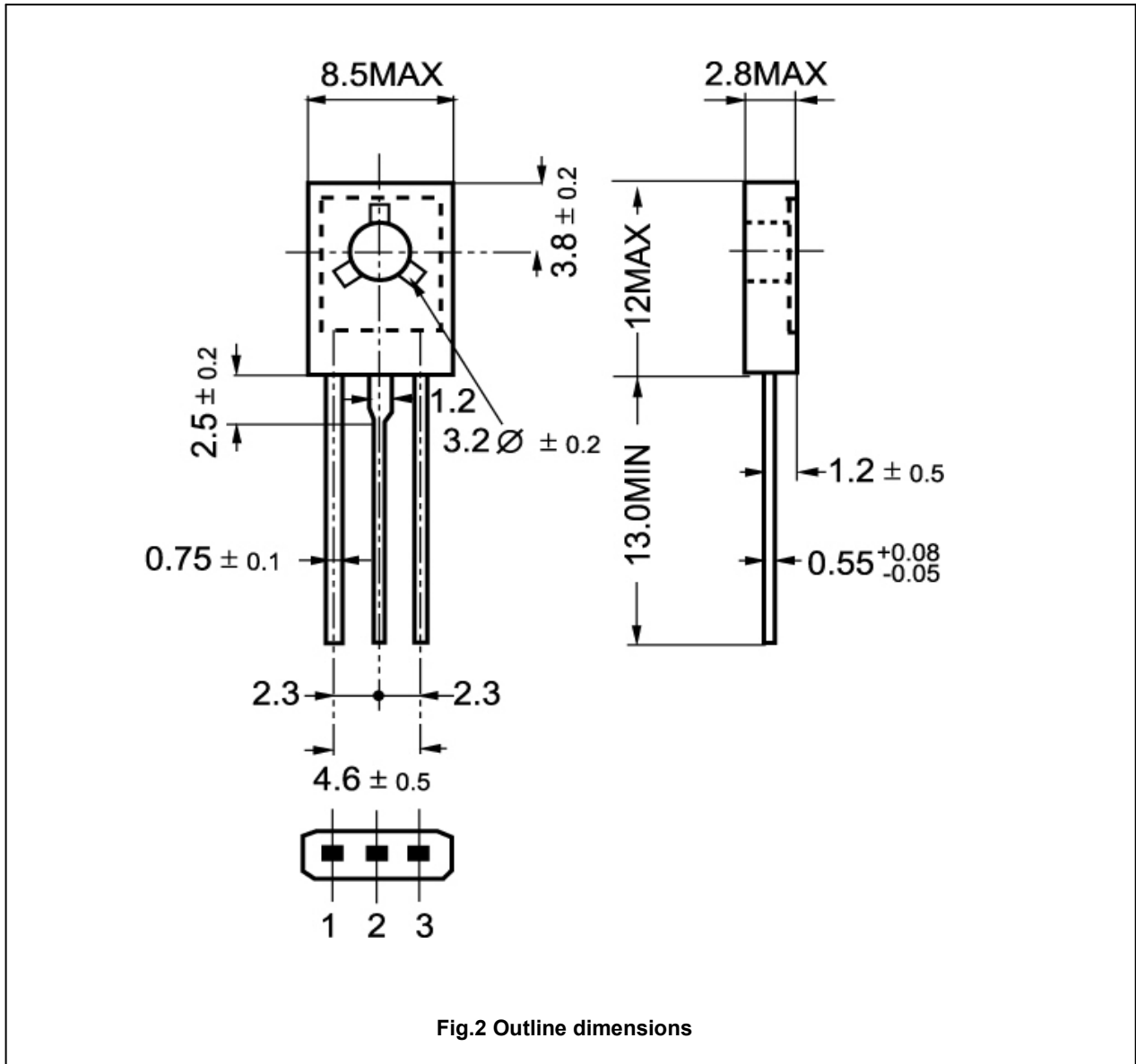

Silicon NPN Power Transistors

2SC3619

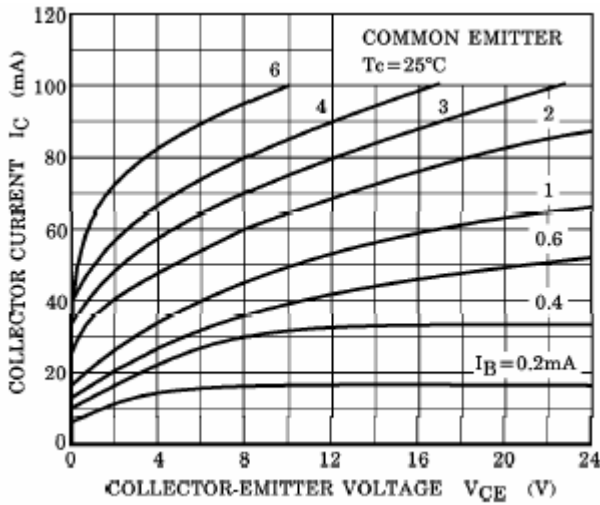

Fig.3 Static Characteristic

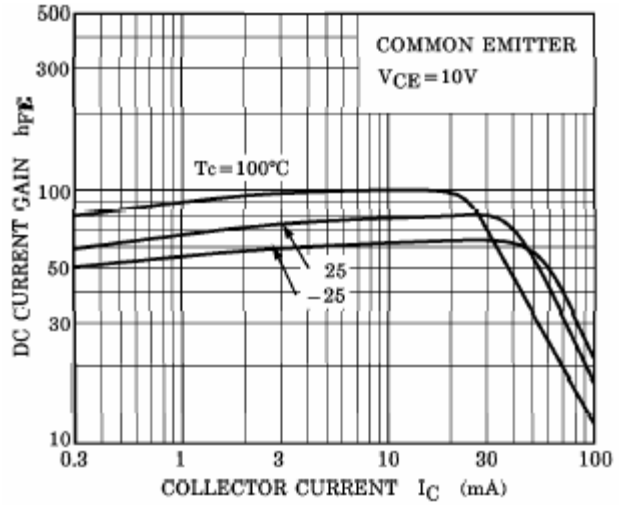

Fig.4 DC current Gain

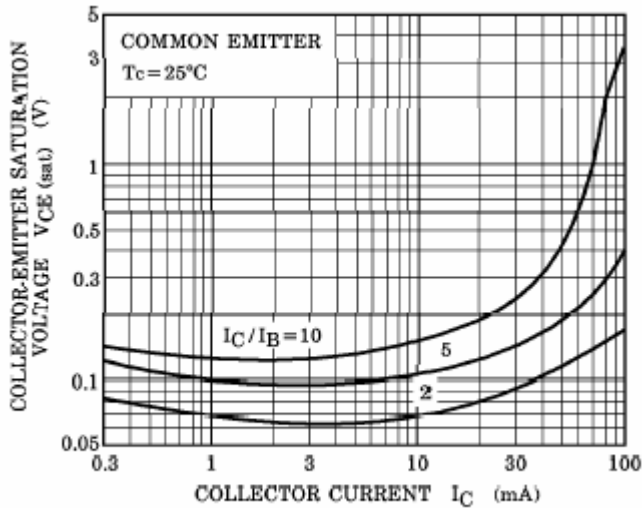

Fig.5 Collector-Emitter Saturation Voltage

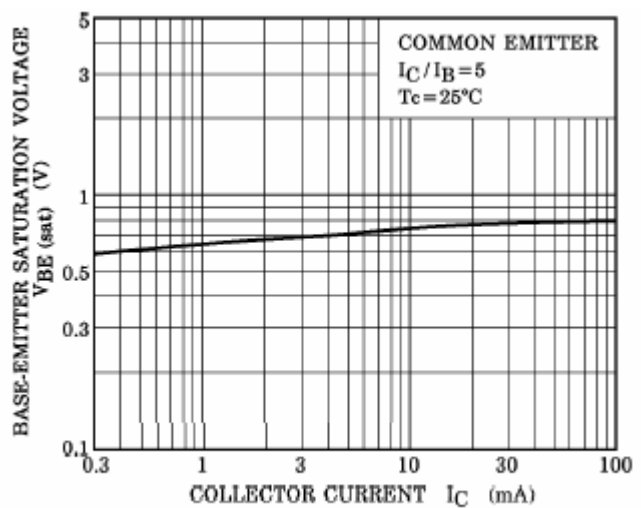

Fig.6 Base-Emitter Saturation Voltage

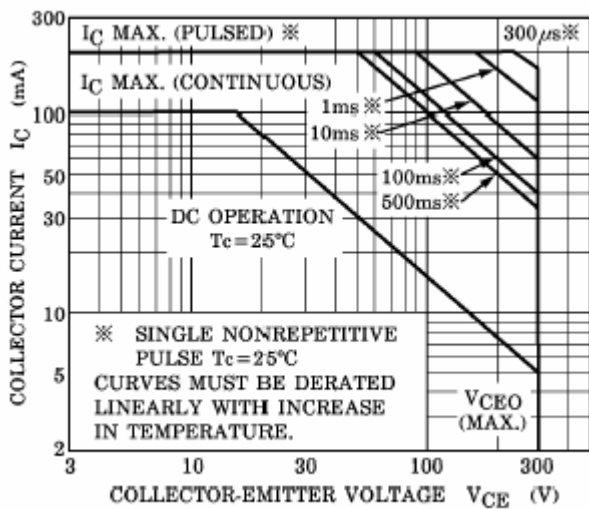

Fig.7 Safe Operating Area