



EVERLIGHT ELECTRONICS CO.,LTD.

Device Number : DLE-039-008 REV: 1.2

7.9mm Round Type LED Lamps

MODEL NO : 393ID ECN : _____ Page: 1/4

■ Features :

- Choice of various viewing angles
- Available on tape and reel
- Reliable and robust

■ Description :

- The series is specially designed for applications requiring higher brightness than that achievable with standard lamp.
- The LED lamp are available with different colors, light intensities, epoxy colors, etc.

■ Applications :

- TV set
- Monitor
- Telephone
- Computer

■ Package Dimension:

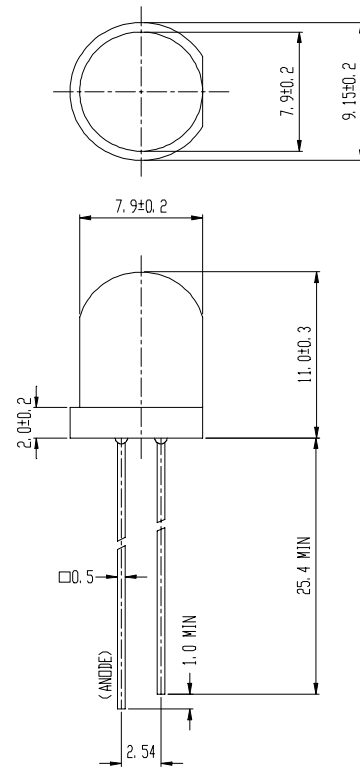

■ NOTES :

1. All dimensions are millimeters.
2. An epoxy meniscus may extend about 1.5mm(0.059") down the lead.

PART NO	CHIP		Lens Color
	Material	Emitted Color	
393ID	GaAsP/GaP	Hi-Eff Red	Red Diffused

DESIGNER	CHECKER	APPROVER

Office : NO 25,Lane 76,Chung Yang Rd,Sec.3
Tucheng,Taipei 236,Taiwan,R.O.C.

TEL : 886-2-2267-2000,2266-9936(22 Lines)

FAX : 886-2-2267-6189



7.9mm Round Type LED Lamps

Absolute Maximum Ratings at TA = 25°C

Parameter	Symbol	Rating	Unit
Forward Current	If	30	mA
Operating Temperature	Topr	-40 to +85	°C
Storage Temperature	Tstg	-40 to +100	°C
Soldering Temperature	Tsol	260 ± 5	°C
Power Dissipation	Pd	100	mW
Peak Forward Current(Duty 1/10 @ 1KHZ)	If(Peak)	160	mA
Reverse Voltage	Vr	5	V

Electronic Optical Characteristics :

Parameter	Symbol	MIN.	TYP.	MAX.	Unit	Condition
Luminous intensity	Iv	2.30	7.50	/	mcd	If= 10 mA
Viewing Angle	2θ 1/2	/	36	/	deg	If= 20 mA
Peak Wavelength	λ p	/	635	/	nm	If= 20 mA
Dominant Wavelength	λ d	/	625	/	nm	If= 20 mA
Spectrum Radiation Bandwidth	Δ λ	/	45	/	nm	If= 20 mA
Forward Voltage	Vf	1.70	2.00	2.60	V	If= 20 mA
Reverse Current	Ir	/	/	10	μ A	Vr= 5 V



7.9mm Round Type LED Lamps

■ Typical Electro-Optical Characteristic Curves

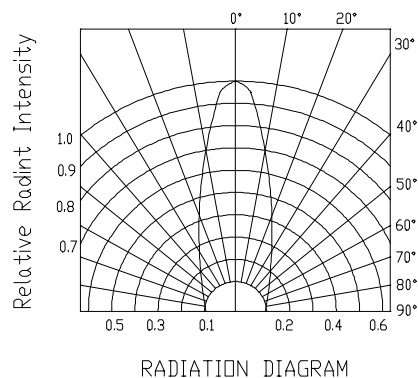
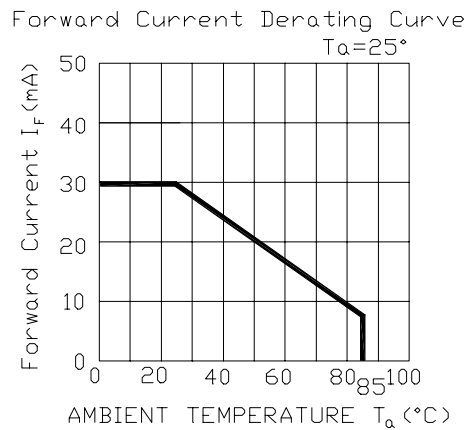
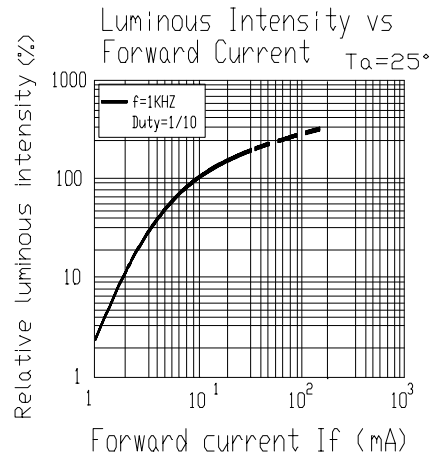
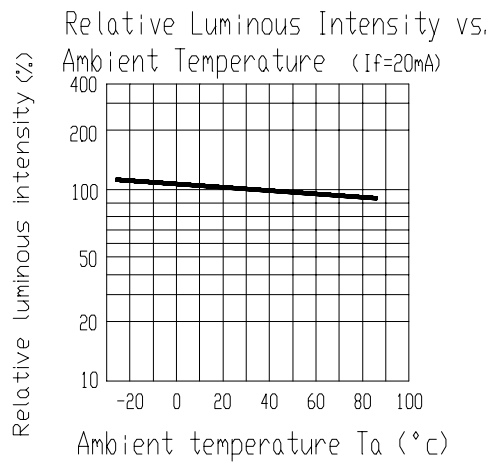
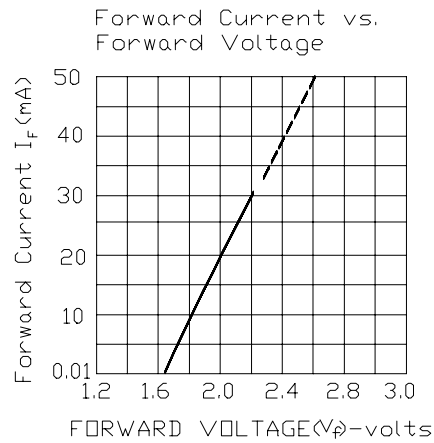
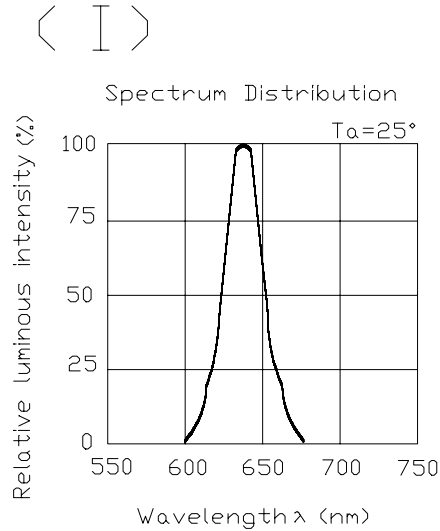



EVERLIGHT ELECTRONICS CO.,LTD.

Device Number : DLE-039-008

REV: 1.2

7.9mm Round Type LED Lamps

MODEL NO : 393ID

ECN :

Page: 4/4

■ Reliability test item and condition

No	Item	Test Conditions	Test Hours/Cycle	Sample Size	Ac/Re
1	Solder Heat	TEMP : 260°C ± 5 °C	5 SEC	76 PCS	0/1
2	Temperature Cycle	H : +85°C 30min ∫ 5 min L : -55°C 30min	50 CYCLE	76 PCS	0/1
3	Thermal Shock	H : +100°C 5min ∫ 10 sec L : -10°C 5min	50 CYCLE	76 PCS	0/1
4	High Temperature Storage	TEMP : 100°C	1000 HRS	76 PCS	0/1
5	Low Temperature Storage	TEMP : -55°C	1000 HRS	76 PCS	0/1
6	DC Operating Life	If = 20 mA	1000 HRS	76 PCS	0/1
7	High Temperature / High Humidity	85°C/85% RH	1000 HRS	76 PCS	0/1