



## FAST RECOVERY RECTIFIER

FR801 THRU FR806

VOLTAGE RANGE

50 to 1000 Volts

CURRENT

8.0 Ampere

### FEATURES

- Glass passivated chip junction
- Low cost construction
- Fast switching for high efficiency
- Low reverse leakage
- High forward surge current capacity
- High temperature soldering guaranteed
- 260°C/10 second, 0.375" (9.5mm) lead length
- at 5 lbs (2.3kg) tension

### MECHANICAL DATA

- Case: Transfer molded plastic
- Epoxy: UL94V-0 rate flame retardant
- Polarity: Color band denotes cathode end
- Lead: Plated axial lead, solderable per MIL-STD-202E method 208C
- Mounting position: Any
- Weight: 0.064ounce, 1.81 gram

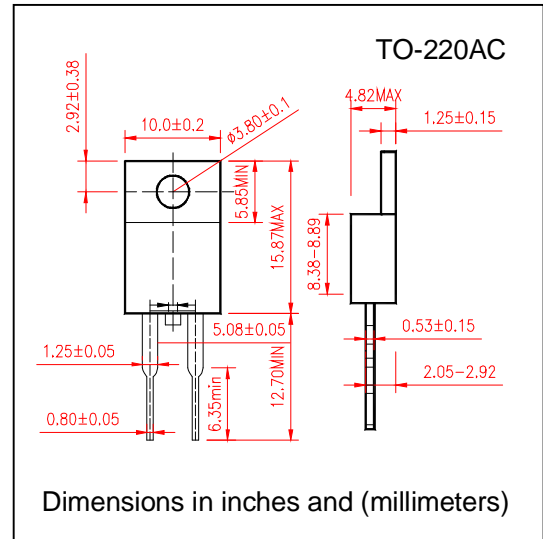

### MAXIMUM RATINGS AND ELECTRICAL CHARACTERISTICS

- Ratings at 25°C ambient temperature unless otherwise specified
- Single Phase, half wave, 60Hz, resistive or inductive load
- For capacitive load derate current by 20%

	SYMBOLS	FR801	FR802	FR803	FR804	FR805	FR806	UNIT
Maximum Repetitive Peak Reverse Voltage	$V_{RRM}$	50	100	200	400	600	800	Volts
Maximum RMS Voltage	$V_{RMS}$	35	70	140	280	420	560	Volts
Maximum DC Blocking Voltage	$V_{DC}$	50	100	200	400	600	800	Volts
Maximum Average Forward Rectified Current 0.375" (9.5mm) lead length at $T_C=100^\circ C$	$I_{(AV)}$	8.0						Amps
Peak Forward Surge Current 8.3ms single half sine wave superimposed on rated load (JEDEC method)	$I_{FSM}$	200						Amps
Maximum Instantaneous Forward Voltage at 8.0A	$V_F$	1.3						Volts
Maximum DC Reverse Current at rated DC Blocking Voltage per element	$T_A = 25^\circ C$	10						$\mu A$
	$T_A = 100^\circ C$	500						
Maximum Reverse Recovery Time (NOTE 3) $T_j=25^\circ C$	$t_{rr}$	150			250	500		nS
Typical Junction Capacitance (NOTE 1)	$C_J$	50						pF
Typical Thermal Resistance (NOTE 2)	$R_{\theta JC}$	3.0						$^\circ C/W$
Operating and Storage Temperature Range	$T_J$	(-55 to +150)						$^\circ C$
Storage Temperature Range	$T_{STG}$	(-55 to +150)						$^\circ C$

#### Notes:

1. Measured at 1.0 MHz and applied reverse voltage of 4.0 Volts.
2. Thermal Resistance from Junction to CASE
3. Reverse Recovery Test Conditions:  $I_F=0.5A$ ,  $I_R=1.0A$ ,  $I_{RR}=0.25A$



# FAST RECOVERY RECTIFIER

FR801 THRU FR806

VOLTAGE RANGE 50 to 1000 Volts  
CURRENT 8.0 Ampere

## RATING AND CHARACTERISTIC CURVES FR801G THRU FR806

FIG.1-TYPICAL FORWARD CURRENT DERATING CURVE

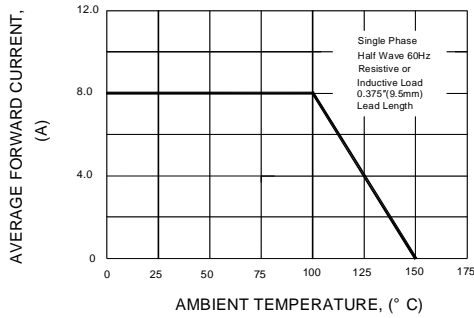

FIG.2-MAXIMUM NON-REPETITIVE PEAK FORWARD SURGE CURRENT

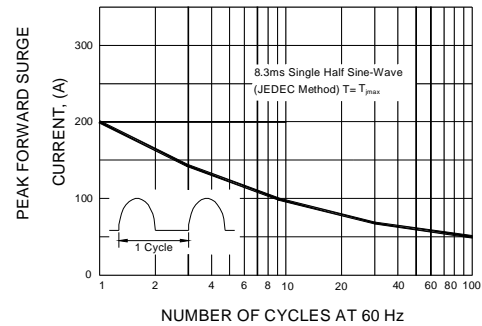

FIG.3-TYPICAL INSTANTANEOUS FORWARD CHARACTERISTICS

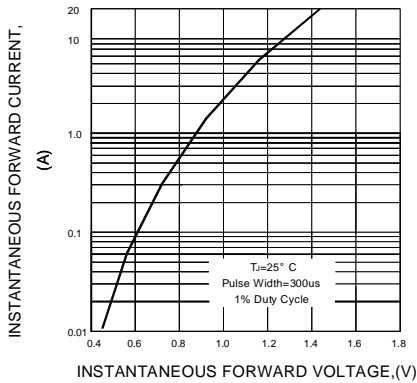

FIG.4-TYPICAL REVERSE CHARACTERISTICS

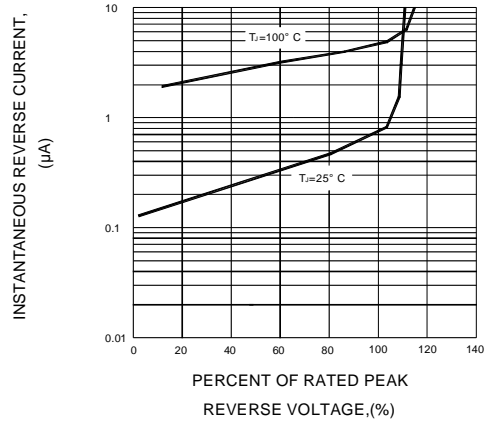

FIG.5-TYPICAL JUNCTION CAPACITANCE

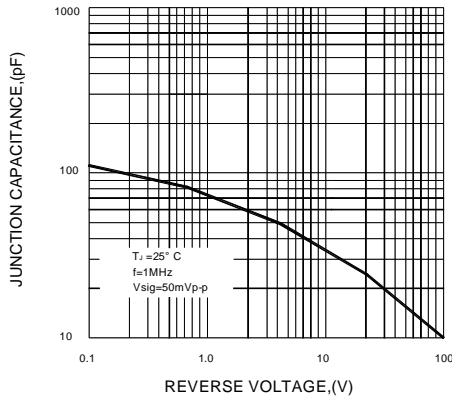
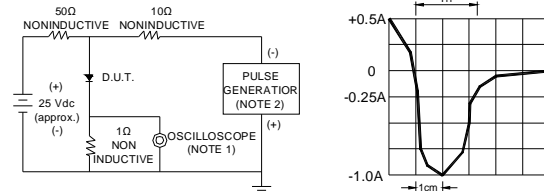

FIG.6-TEST CIRCUIT DIAGRAM AND REVERSE RECOVERY TIME CHARACTERISTIC



NOTES : 1. Rise Time = 7ns max. Input Impedance = 1 megohm. 22pF  
2. Rise time = 10ns max. Source Impedance = 50 ohms

SET TIME BASE FOR 50/100ns/cm