

– CONTENTS –

1. Features
2. Outline dimensions
3. Package material
4. Absolute Maximum Ratings
5. Electrical Optical Characteristics
6. Taping
7. Packing Structure
8. Characteristic Diagrams
9. Spectrum Distribution
10. Radiation Characteristics
11. Cautions
12. Reliability
13. Warranty
14. Others

1. Features

- Package : SMD Top View Type(3Chips In 1)
- Colorless transparency
- Dimension : 3.5 × 2.7 × 1.8 mm(L×W×H)
- small size surface mount type
- Viewing angle : extremely wide(120°)
- Soldering methods : IR reflow soldering
- Taping : 8 mm conductive black carrier tape & antistatic clear cover tape.
2,000pcs/reel, Φ180 mm wheel

2. Outline dimensions

(unit : mm)

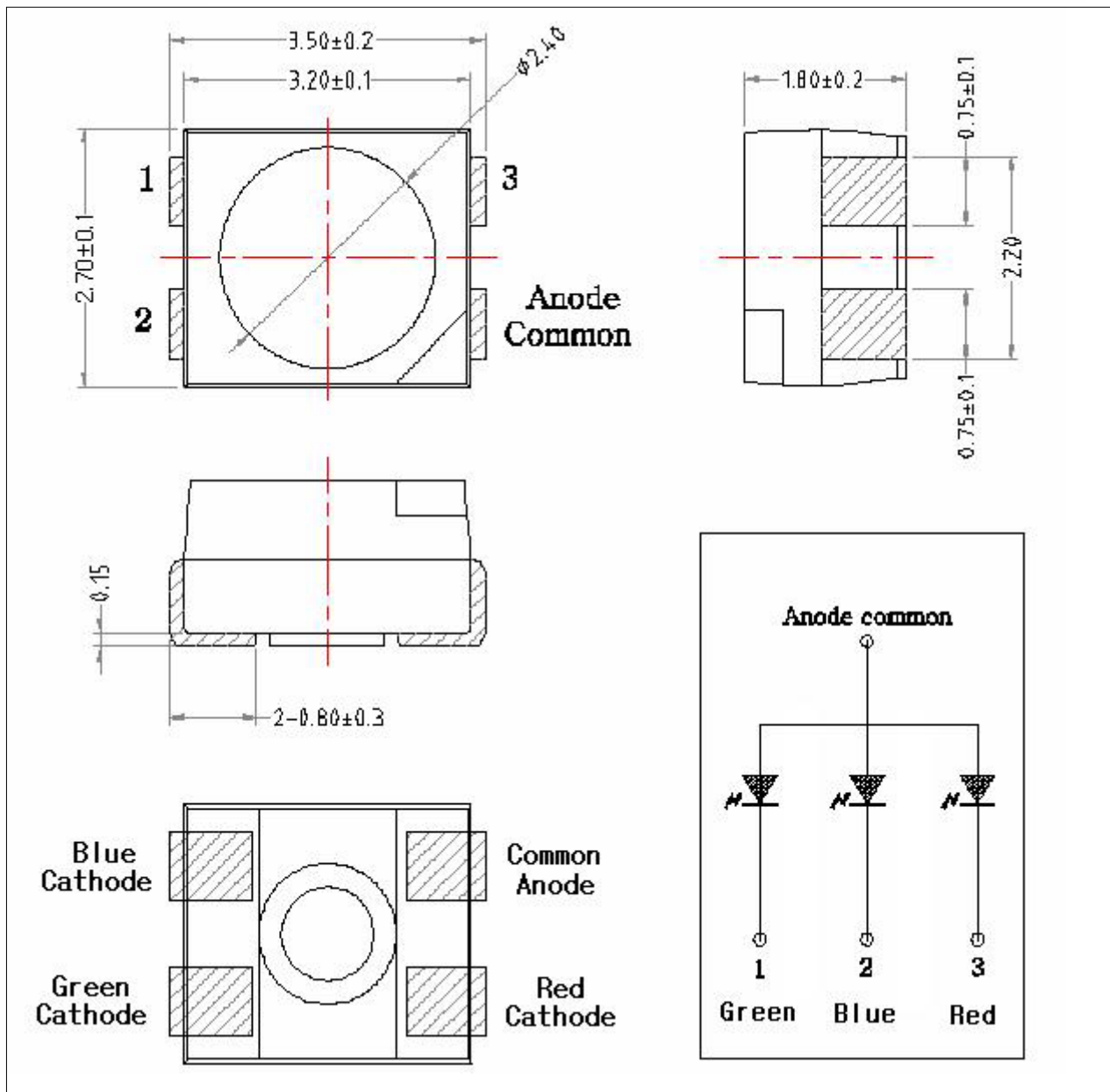

3. Package material

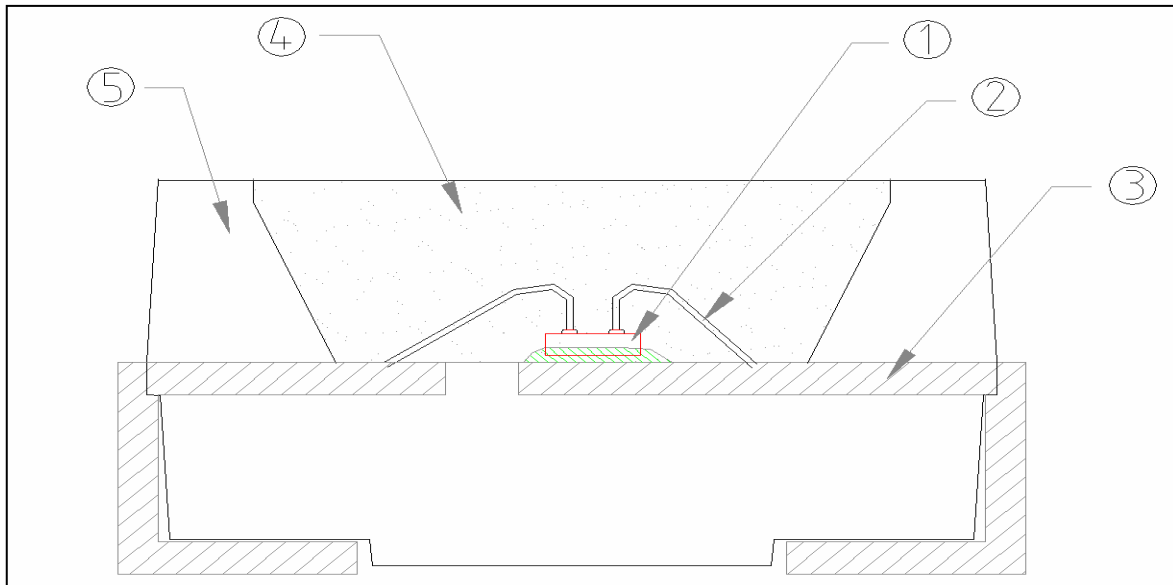

(1) Material construction

Number	Item
1	LED Chip
2	Gold Wire
3	Lead Frame
4	Silicone Resin
5	Heat-Resistant Polymer

4. Absolute Maximum Ratings

(Ta = 25°C)

Parameter	Symbol	Value			Unit
		Blue	Green	Red	
Forward Current	I_F	30	30	30	mA
* ¹ Peak Forward Current	I_{FP}	100	100	100	mA
Reverse Voltage	V_R	5			V
Power dissipation	P_D	100			mW
Operating Temperature	T_{opr}	-30 ~ +85			°C
Storage Temperature	T_{stg}	-40 ~ +100			°C
Reflow Soldering Temperature	T_{sol}	Reflow Soldering : 260°C for 10 sec. Hand Soldering : 350°C for 3 sec.			

*1. Duty ratio 1/10, Pulse Width 10msec.

5. Electrical – Optical Characteristics

1)Red

(Ta = 25°C)

Characteristic	Symbol	Test Condition	Min.	Typ.	Max.	Unit
Forward Voltage	V_F	$I_F= 20\text{mA}$	1.8	–	2.4	V
Dominant Wavelength	λ_D	$I_F= 20\text{mA}$	620	–	630	nm
Luminous intensity	I_v	$I_F= 20\text{mA}$	420	–	650	mcd
Spectrum Bandwidth	$\Delta\lambda$	$I_F= 20\text{mA}$	–	20	–	nm
Reverse Current	I_R	$V_R=5\text{V}$	–	–	10	μA
* ² Half Angle	$\theta_{1/2}$	$I_F= 20\text{mA}$	–	± 60	–	deg

*2. $\theta_{1/2}$ is the off-axis angle where the luminous intensity is 1/2 the peak intensity

2)Blue

Characteristic	Symbol	Test Condition	Min.	Typ.	Max.	Unit
Forward Voltage	V_F	$I_F= 20\text{mA}$	3.0	–	3.6	V
Dominant Wavelength	λ_D	$I_F= 20\text{mA}$	450	–	465	nm
Luminous intensity	I_v	$I_F= 20\text{mA}$	110	–	210	mcd
Spectrum Bandwidth	$\Delta\lambda$	$I_F= 20\text{mA}$	–	15	–	nm
Reverse Current	I_R	$V_R=5\text{V}$	–	–	10	μA
* ² Half Angle	$\theta_{1/2}$	$I_F= 20\text{mA}$	–	± 60	–	deg

*2. $\theta_{1/2}$ is the off-axis angle where the luminous intensity is 1/2 the peak intensity

3)Green

Characteristic	Symbol	Test Condition	Min.	Typ.	Max.	Unit
Forward Voltage	V_F	$I_F= 20\text{mA}$	3.0	–	3.6	V
Dominant Wavelength	λ_D	$I_F= 20\text{mA}$	520	–	530	nm
Luminous intensity	I_v	$I_F= 20\text{mA}$	850	–	1200	mcd
Spectrum Bandwidth	$\Delta\lambda$	$I_F= 20\text{mA}$	–	15	–	nm
Reverse Current	I_R	$V_R=5\text{V}$	–	–	10	μA
* ² Half Angle	$\theta_{1/2}$	$I_F= 20\text{mA}$	–	± 60	–	deg

*2. $\theta_{1/2}$ is the off-axis angle where the luminous intensity is 1/2 the peak intensity

6. Taping

(1) Dimension of wheel (Material : PS Conductive, 10GΩ~1TΩ)

(Units : mm)

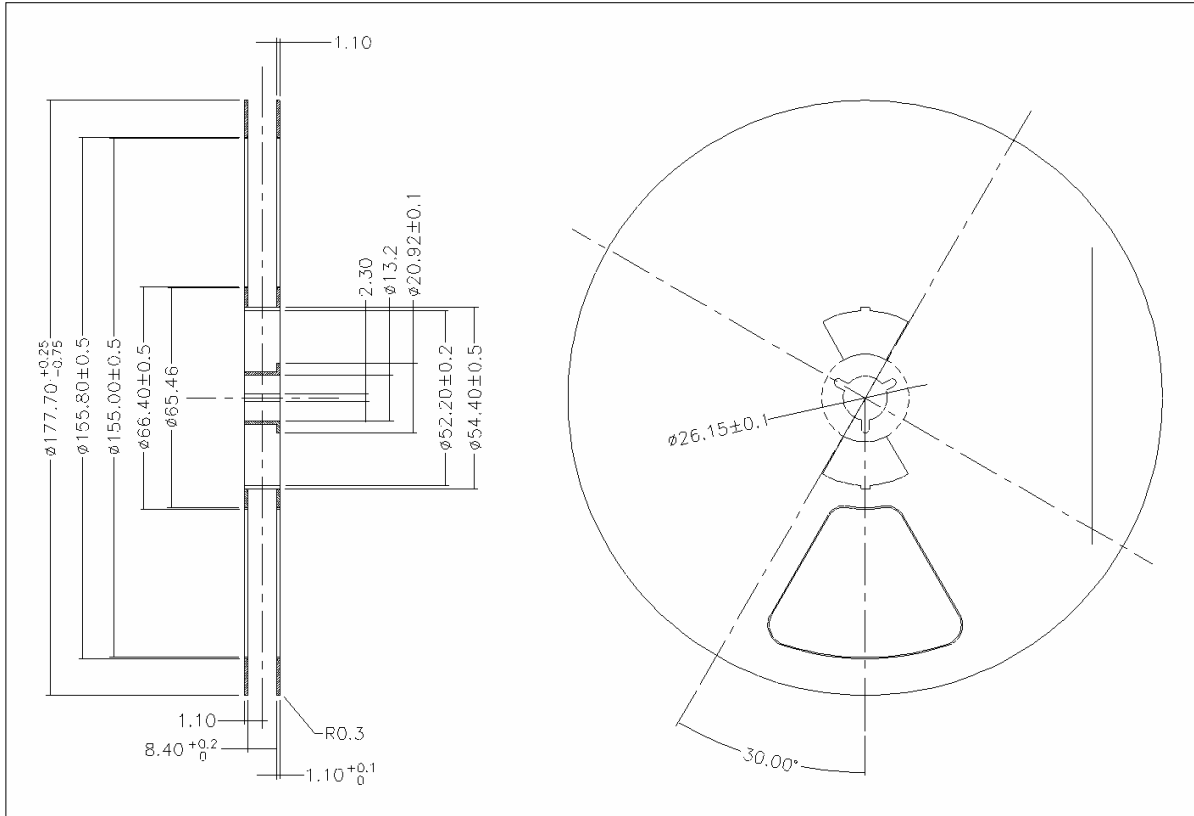

(2) Dimension of tape (Material : PS Conductive, 10~100KΩ)

(Units : mm)

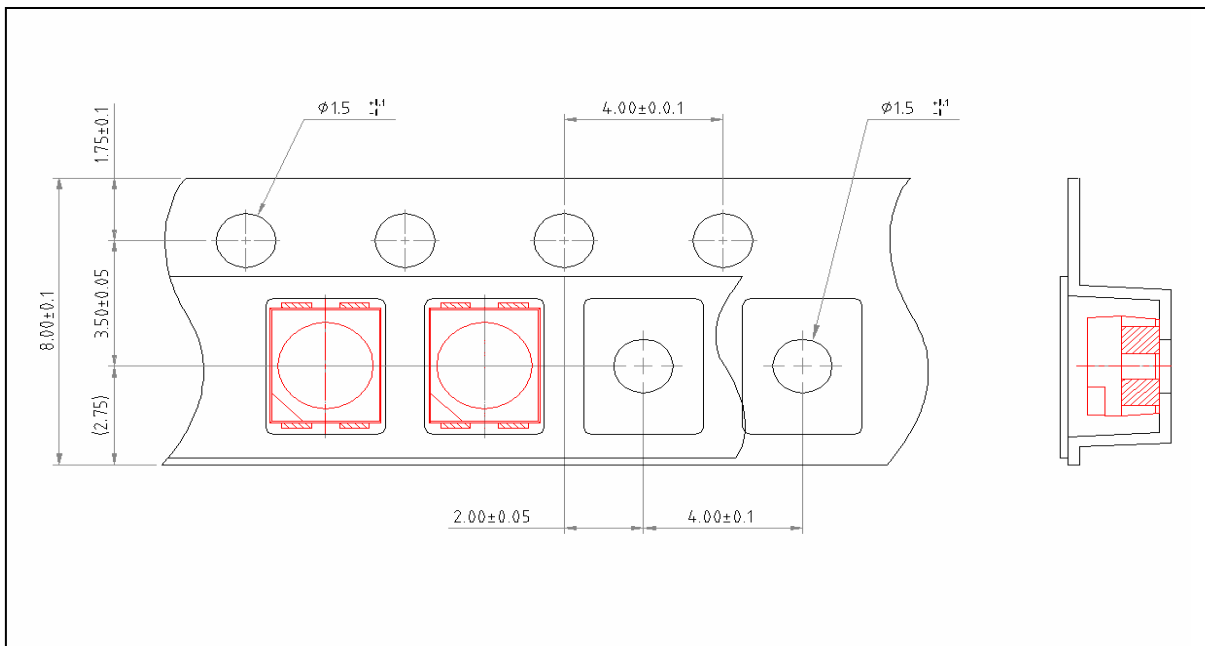

(3) Details of CHIP LEDs loading on tape

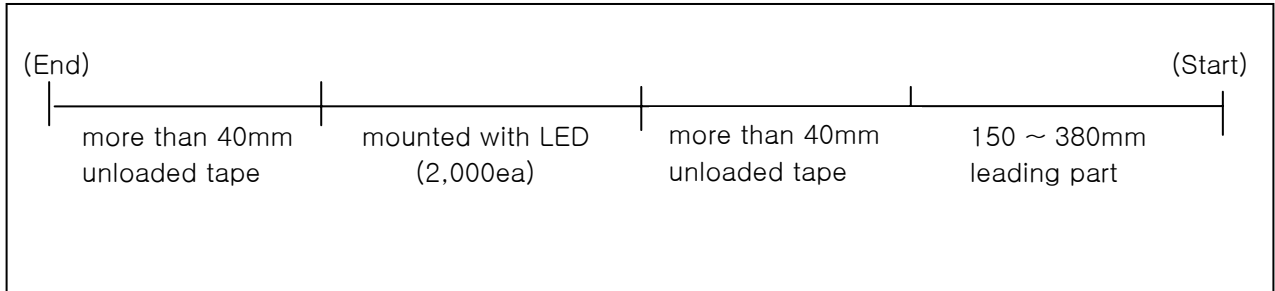

(4) Loading quantity per reel : 2,000pcs

(5) Label Outline

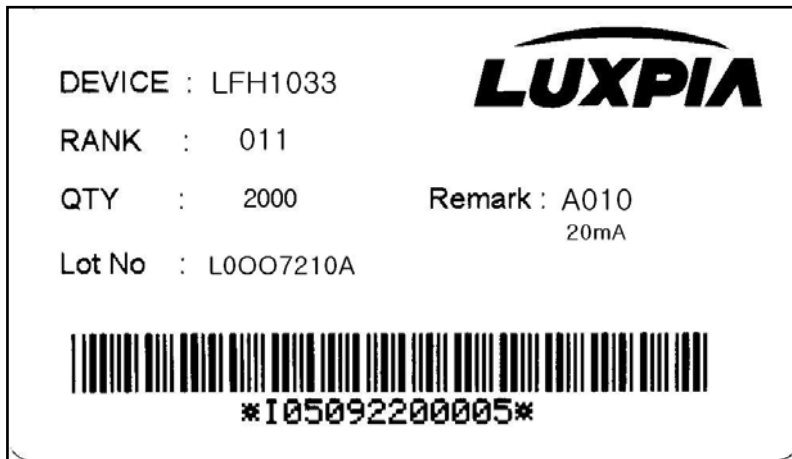

DEVICE : LFH1033
RANK : 011
QTY : 2000
Lot No : L0007210A

LUXPIA

Remark : A010
20mA



I05092200005

* SIZE(L X W) : 85mm X 50mm

7. Packing Structure

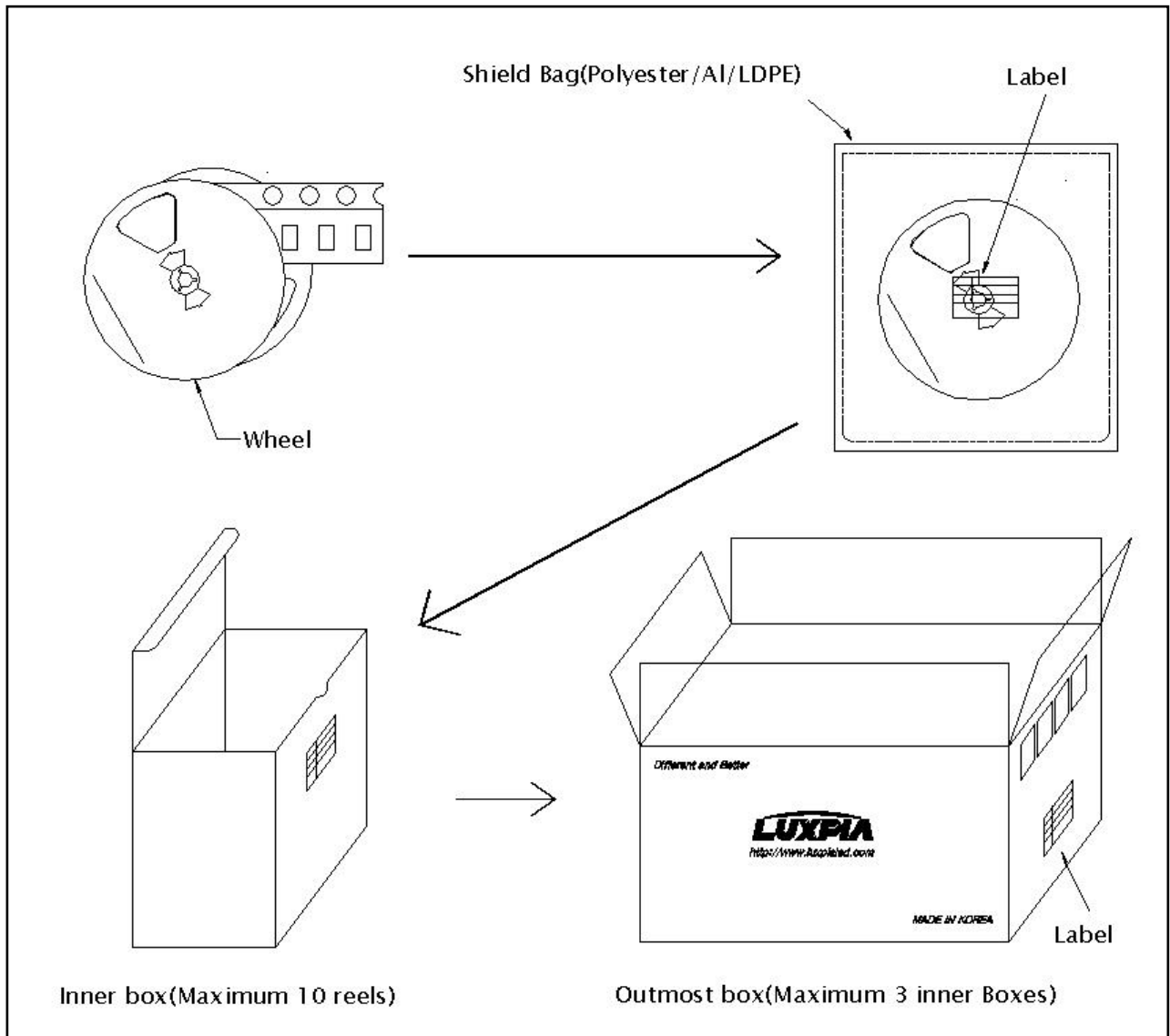

- The LEDs are packed in cardboard boxes after taping.
please refer to figure : page 6
The label on the minimum packing unit shows : Part Number, Lot Number, Rank and Quantity.
- In order to protect the LEDs from mechanical shock, we pack them in cardboard boxes for transportation.
- The LEDs may be damaged if the boxes are dropped or receive a strong impact against them, so precautions must be taken.
- The boxes are not water resistant and therefore must be kept away from water and moisture.
- When the LEDs are transported, we recommend that you use the same packing method as Luxpia.
- If a box shows noticeable damage upon arrival at the User's warehouse, it is highly recommended that the User submit a claim to Luxpia within one week after arrival of the products. If the submitted notice regarding the damage exceeds the aforementioned one week.

8. Characteristic Diagrams

1) Red

(1) Relative Luminous Intensity

vs Forward Current (I_f - I_v)

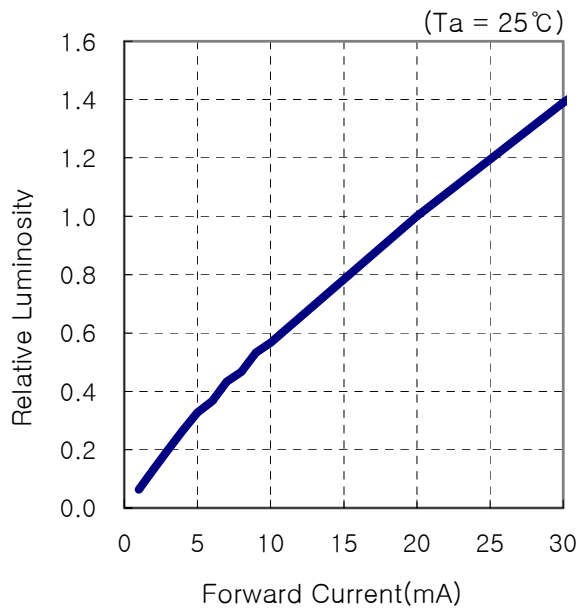

(2) Max. Permissible Forward Current

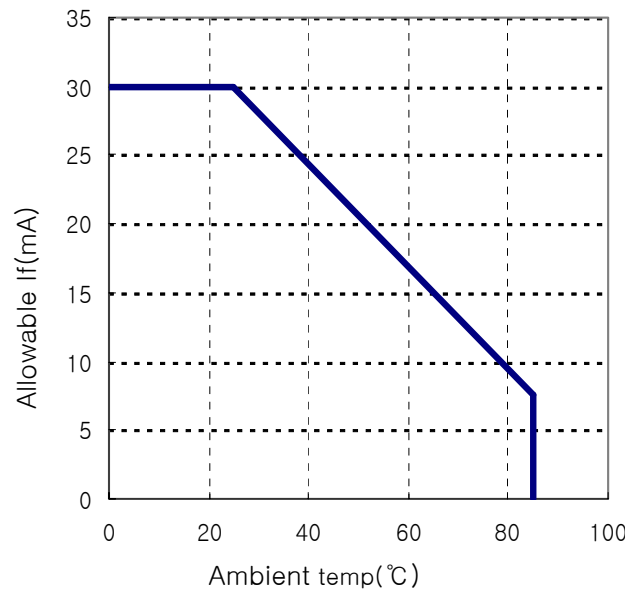

(3) Forward Current vs Forward Voltage (I_f - V_f)

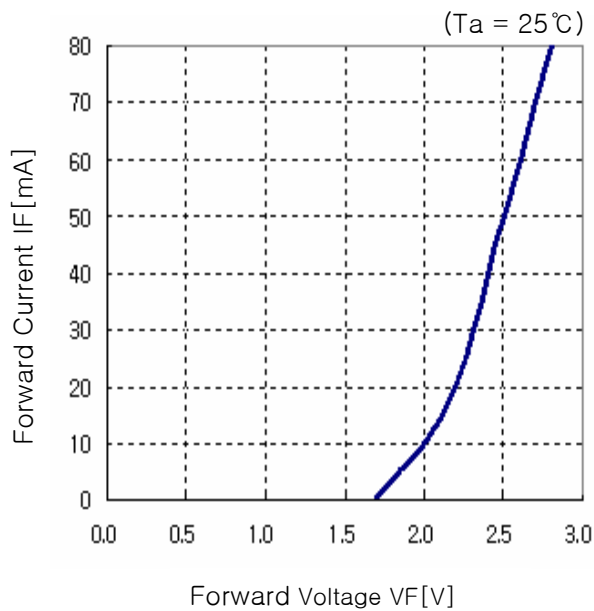

(4) Ambient Temperature vs Relative Luminosity

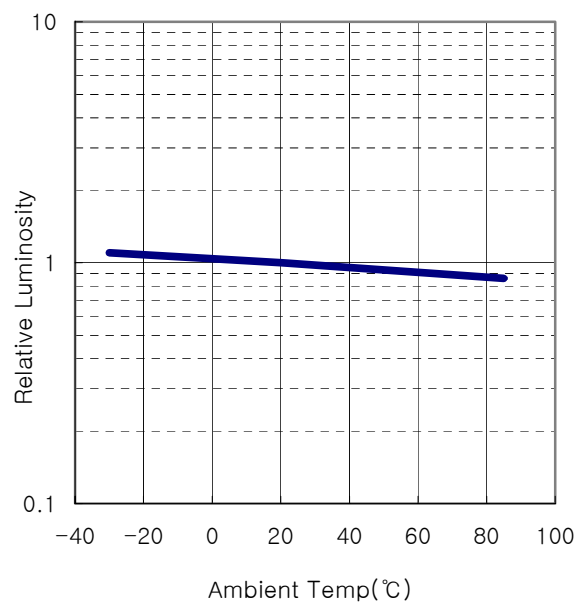

2)Blue

(1) Relative Luminous Intensity vs Forward Current (I_f - I_v)

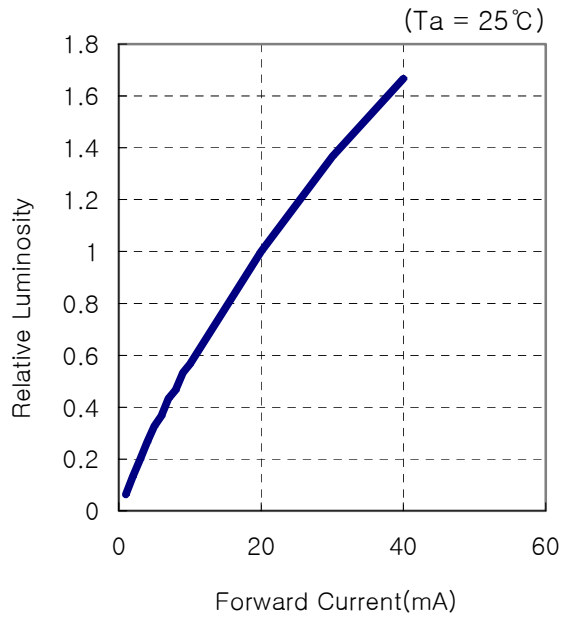

(2) Max. Permissible Forward Current

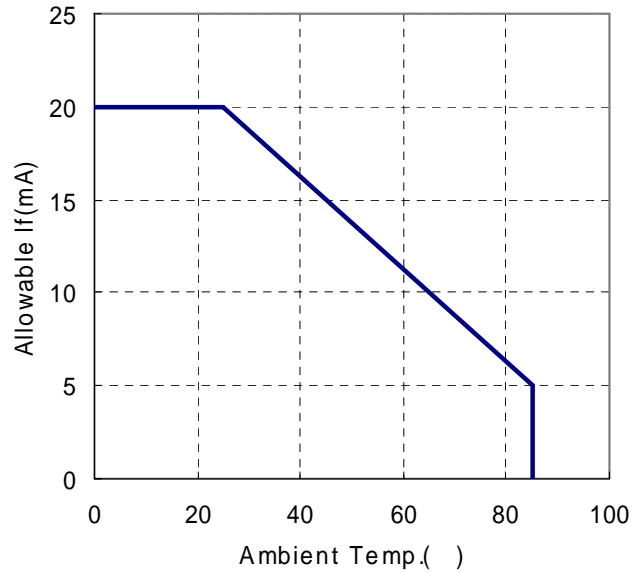

(3) Forward Current vs Forward Voltage (I_f - V_f)

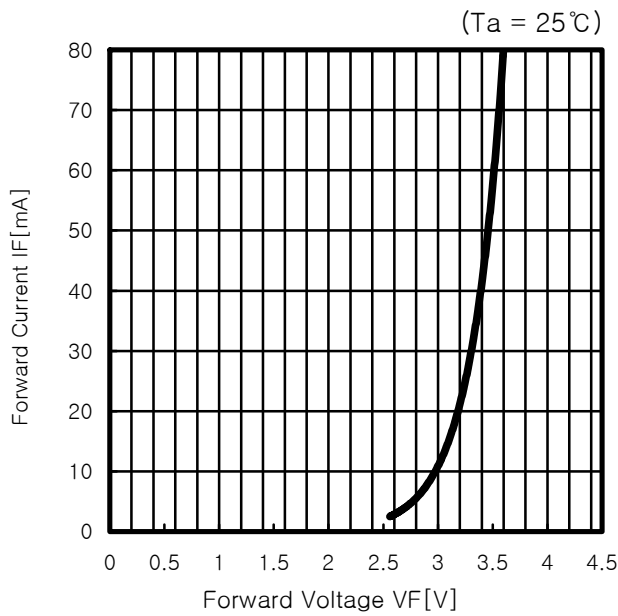

(4) Ambient Temperature vs Relative Luminosity

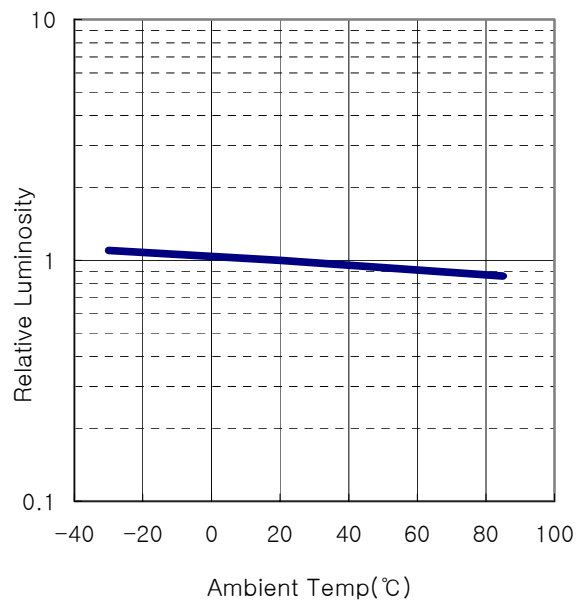

3)Green

(1) Relative Luminous Intensity vs Forward Current (I_F-I_v)

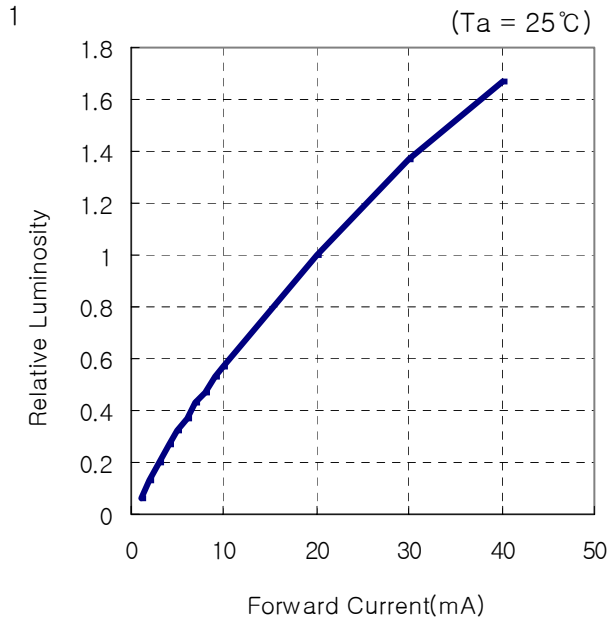

(2) Max. Permissible Forward Current

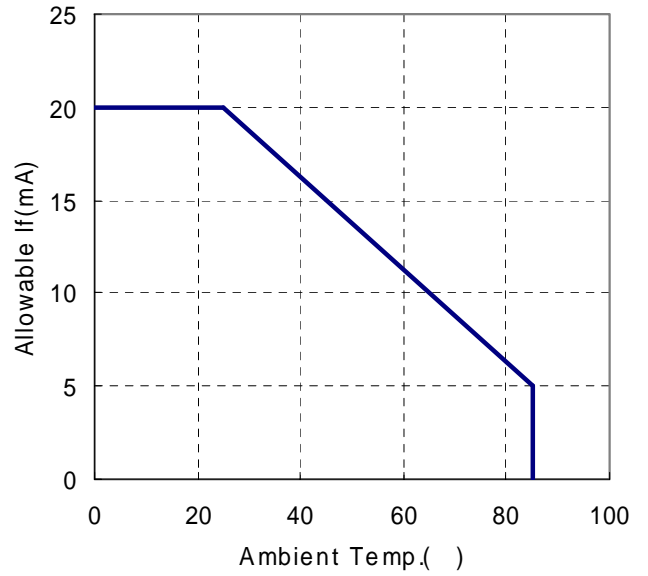

(3) Forward Current vs Forward Voltage (I_F-V_F)

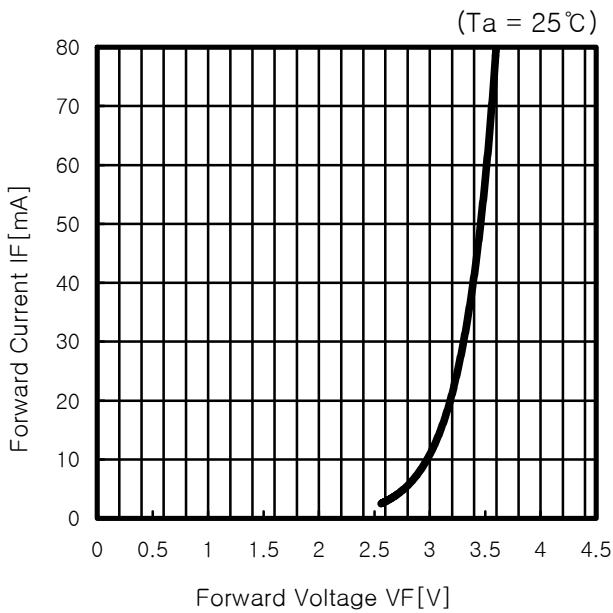

(4) Ambient Temperature vs Relative Luminosity

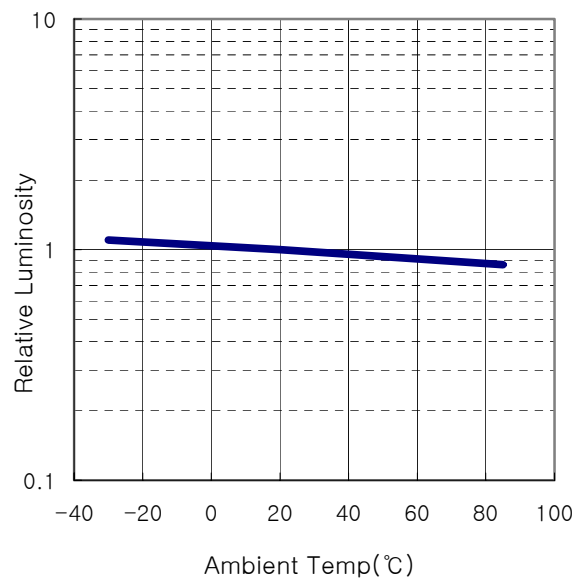

9. Spectrum Distribution

(Ta = 25°C, If=20mA)

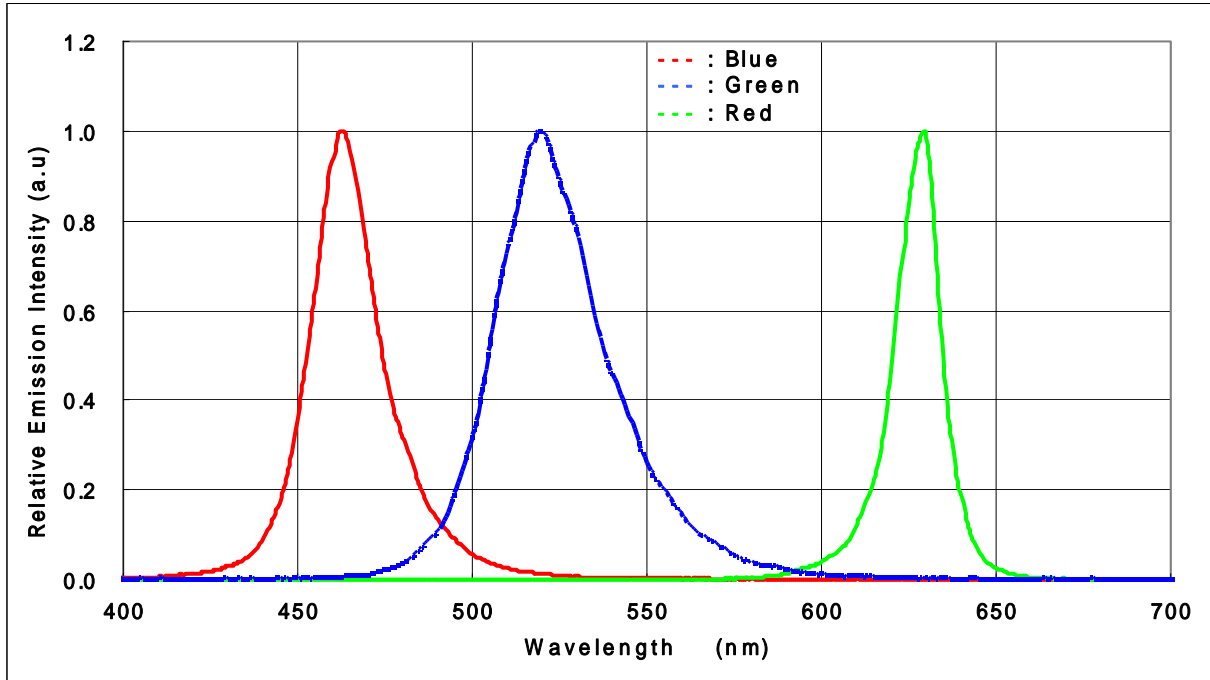

10. Radiation Characteristics

(Ta = 25°C, If=20mA)

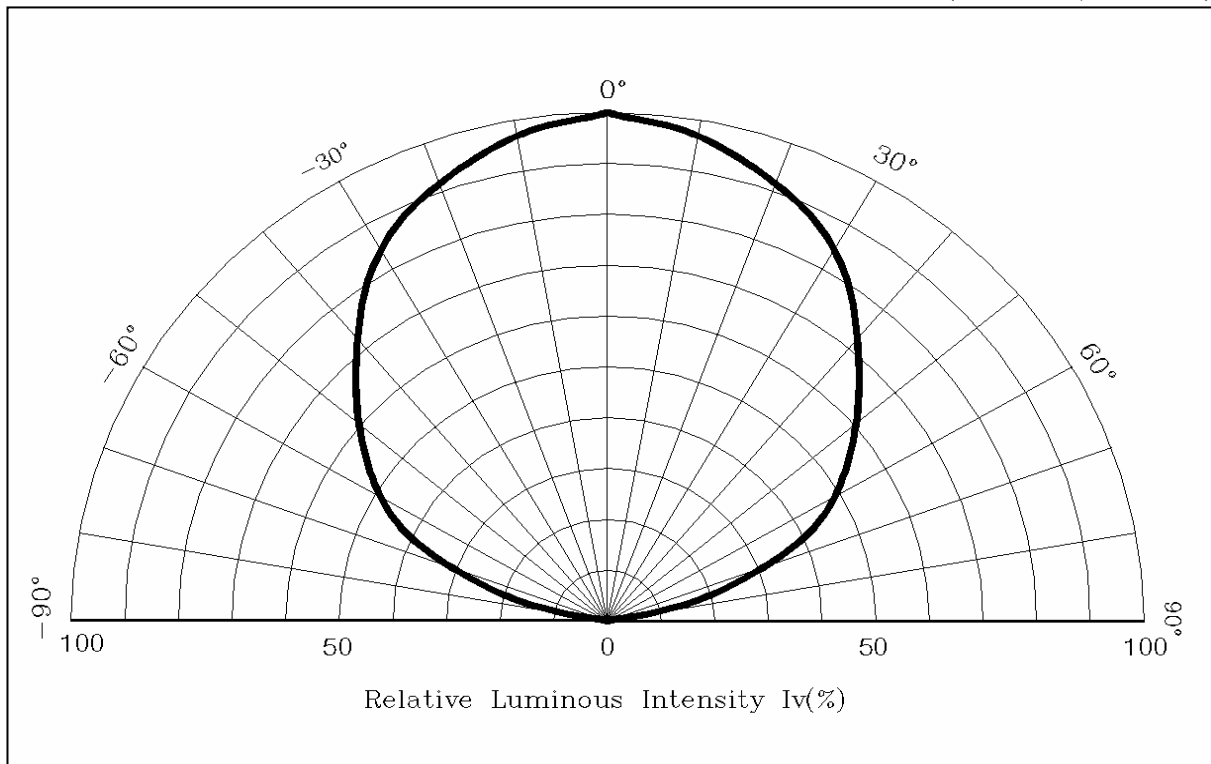

11. Cautions

(1) Moisture Proof Package

- When moisture is absorbed into the SMT package it may vaporize and expand during soldering. There is a possibility that this can cause exfoliation of the contacts and damage to the optical characteristics of the LEDs. For this reason, the moisture proof package is used to keep moisture to a minimum in the package.
- A package of a moisture absorbent material (silica gel) is inserted into the shielding bag. The silica gel changes its color from blue to pink as it absorbs moisture.

(2) Storage

• Storage Conditions

Before opening the package :

The LEDs should be kept at 30°C or less and 90%RH or less. The LEDs should be used within a year. When storing the LEDs, moisture proof packaging with absorbent material (silica gel) is recommended.

After opening the package :

The LEDs should be kept at 30°C or less and 70%RH or less. The LEDs should be soldered within 168 hours (7days) after opening the package. If unused LEDs remain, they should be stored in moisture proof packages, such as sealed containers with packages of moisture absorbent material (silica gel). It is also recommended to return the LEDs to the original moisture proof bag and to reseal the moisture proof bag again.

- If the moisture absorbent material (silica gel) has faded away or the LEDs have exceeded the storage time, baking treatment should be performed using the following conditions.
Baking treatment : more than 24 hours at 65±5°C.
- Luxpia LED electrode sections are comprised of a silver plated copper alloy. The silver surface may be affected by environments which contain corrosive gases and so on. Please avoid condition may cause difficulty during soldering operations. It is recommended that the User use the LEDs as soon as possible.
- Please avoid rapid transitions in ambient temperature, especially in high humidity environments where condensation can occur.

(3) Heat Generation

- Thermal design of the end product is of paramount importance. Please consider the heat generation of the LED when making the system design. The coefficient of temperature increase per input electric power is affected by the thermal resistance of the circuit board and density of LED placement on the board, as well as other components. It is necessary to avoid intense heat generation and operate within the maximum ratings given in this specification.
- The operating current should be decided after considering the ambient maximum temperature of LEDs.

(4) Soldering Conditions

- The LEDs can be soldered in place using the reflow soldering method. Luxpia cannot make a guarantee on the LEDs after they have been assembled using the dip soldering method.
- Recommended soldering conditions

	Reflow Soldering		Hand Soldering	
	Lead Solder	Lead-free Solder	Temperature	Soldering time
Pre-heat	120~150°C	180~200°C		
Pre-heat time	120sec Max	120sec Max		
Peak temperature	240°C Max	260°C Max		
Soldering time	10sec Max	10sec Max		

* After reflow soldering rapid cooling should be avoided.

Temperature-profile (Surface of circuit board)

Use the conditions shown to the under figure.

[① : Lead Solder]

[② : Lead-free Solder]

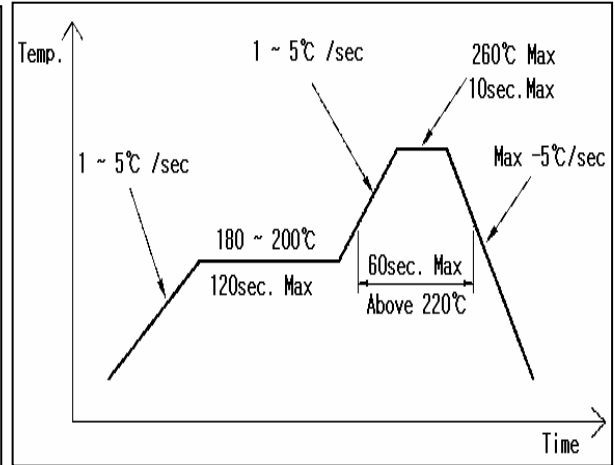
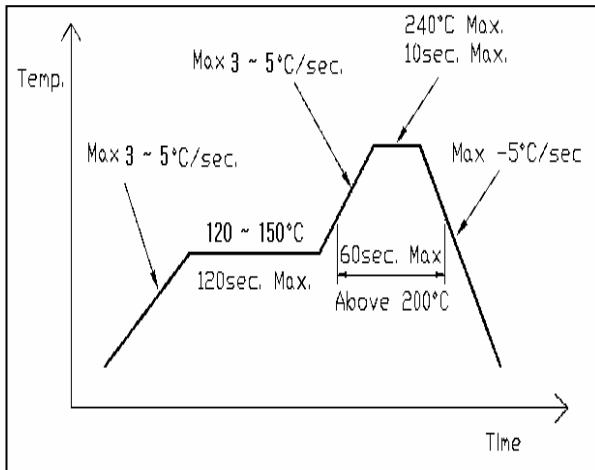

[Recommended soldering pad design]

Use the following conditions shown in the figure.

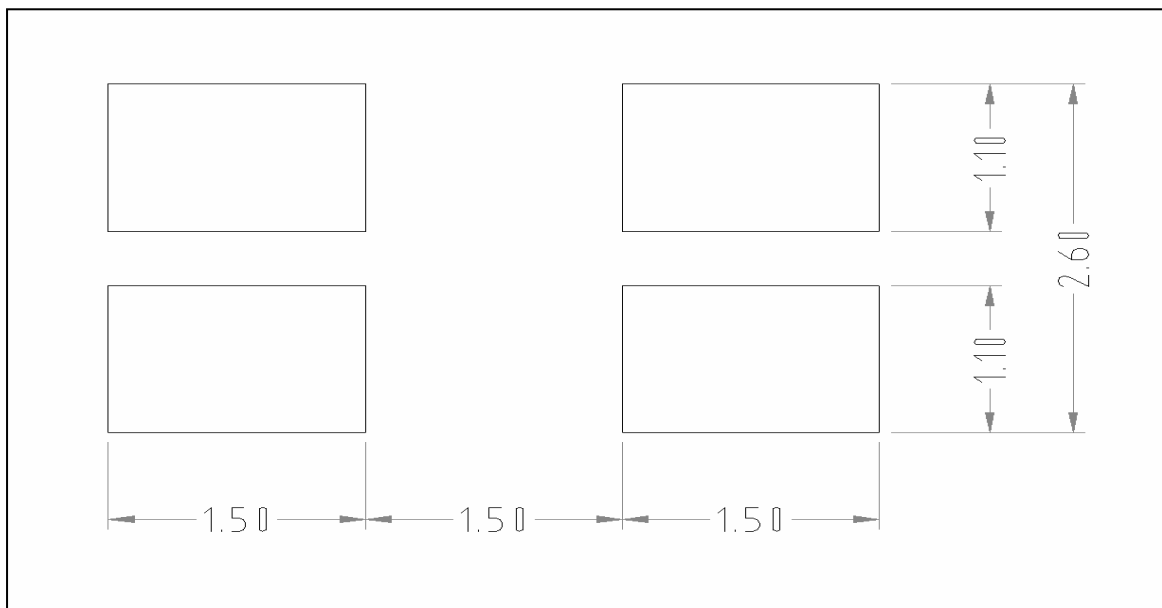

- Occasionally there is a brightness decrease caused by the influence of heat or ambient atmosphere during air reflow. It is recommended that the User use the nitrogen reflow method.
- Repairing should not be done after the LEDs have been soldered. When repairing is unavoidable, a double-head soldering iron should be used. It should be confirmed beforehand whether the characteristics of the LEDs will or will not be damaged by repairing.
- Reflow soldering should not be done more than two times.
- When soldering, do not put stress on the LEDs during heating.
- After soldering, do not warp the circuit board.

(5) Cleaning

- It is recommended that isopropyl alcohol be used as a solvent for cleaning the LEDs. When using other solvents, it should be confirmed beforehand whether the solvents will dissolve the package and the resin or not. Freon solvents should not be used to clean the LEDs because of worldwide regulations. Do not clean the LEDs by the ultrasonic. When it is absolutely necessary, the influence of ultrasonic cleaning on the LEDs depends on factors such as ultrasonic power and the assembled condition. Before cleaning, a pre-test should be done to confirm whether any damage to the LEDs will occur.

(6) Static Electricity

- Static electricity or surge voltage damages the Blue & Green LEDs. It is recommended that a wrist band or an anti-electrostatic glove be used when handling the LEDs.
- All devices, equipment and machinery must be properly grounded. It is recommended that measures be taken against surge voltage to the equipment that mounts The LEDs.
- When inspecting the final products in which LEDs were assembled, it is recommended to check whether the assembled LEDs are damaged by static electricity or not. It is easy to find static-damaged LEDs by a light-on test or a VF test at a lower current (below 1mA is recommended).
- Damaged LEDs will show some unusual characteristics such as the leak current remarkably increases, the forward voltage becomes lower, or the LEDs do not light at the low current.
Criteria : (VF > 2.0V at IF=0.5mA)

(7) Others

- Care must be taken to ensure that the reverse voltage will not exceed the absolute maximum rating when using the LEDs with matrix drive.
- The LED light output is strong enough to injure human eyes. Precautions must be taken to prevent looking directly at the LEDs with unaided eyes for more than a few seconds.
- Flashing lights have been known to cause discomfort in people; you can prevent this by taking precautions during use. Also, people should be cautious when using equipment that has had LEDs incorporated into it.

12. Reliability

(1) The Reliability criteria of SMD LED

ITEM	Symbol	Test Condition	Limit	
			Min.	Max.
Forward Voltage	V _F	I _F = 20mA	I.V × 0.9	I.V × 1.1
Reverse Current	I _R	V _R = 5V	-	10uA
Luminous intensity	I _v	I _F = 20mA	I.V × 0.5	-

* I.V : Initial Value U : Upper Spec Limit L : Lower Spec Limit

* These values are based on 1-die performance

(2) Results of reliability Test

NO	Item	Test Conditions	Time	Ac/Re
1	Steady State Operating Life	T _a =25°C B I _F = 20mA G I _F = 20mA R I _F = 20mA	500hrs	0/22
2	Steady State Operating Life of Low Temperature	T _a =-30°C B I _F = 20mA G I _F = 20mA R I _F = 20mA	500hrs	0/22
3	Steady State Operating Life of High Temperature	T _a =85°C B I _F = 5mA G I _F = 5mA R I _F = 5mA	500hrs	0/22
4	Steady State Operating Life of High Humidity Heat	T _a =60°C, RH=90%, B I _F = 10mA G I _F = 10mA R I _F = 10mA	500hrs	0/22
5	Temperature Cycle	T _a =-40°C~25°C~100°C~25°C Time=30min~5min~30min~5min	100Cycle	0/22
6	Low Temperature Storage	T _a =-40°C	500hrs	0/22
7	High Temperature Storage	T _a =100°C	500hrs	0/22
8	Temperature Humidity Storage	T _a =60°C, RH=90%	500hrs	0/22
9	SHT(Reflow)	T _{sld} =260°C, 10sec	1 time	0/22
10	Solderability(Reflow)	T _{sld} =215±5°C, 3sec	1 time (over5%)	0/22

13. Warranty

- (1) Luxpia warrants that its LEDs conform to the foregoing specifications and that Luxpia will convey good title to all LEDs sold.
- (2) Luxpia Disclaims all other warranties including the implied warranties of merchantability and fitness for a particular purpose.
- (3) In the event any LED supplied by Luxpia is found not to conform to the foregoing specifications within ninety days of receipt, Luxpia will repair or replace the LED, at Luxpia's discretion, provided that the User (1) promptly notifies Luxpia in writing of the details of the defect (2) ships the LEDs at the User's expense to Luxpia for examination, and (3) the defect is due to the negligence of Luxpia and not mishandling or misuse by the User.
- (4) Luxpia will not take responsibility for any trouble that is caused by using the LEDs at conditions exceeding our specifications.
- (5) These specifications are applied only when a LED stands alone and it is strongly recommended that the User of the LEDs confirms the properties upon assembly. Luxpia is not responsible for failures caused during and after assembling. It will be excepted from the rule if the failure would caused undoubtedly by Luxpia.
- (6) A claim report stating details about the defect shall be made when returning defective LEDs. Luxpia will investigate the report immediately and inform the user of the results.
- (7) The LEDs described in this brochure are intended to be used for ordinary electronic equipment (Such as office equipment, communications equipment, on the applications in which exceptional quality and reliability are required, particularly when the failure or malfunction of the LEDs may directly jeopardize life or health (such as for airplanes, aerospace, submersible repeaters, nuclear reactor control systems, automobiles, traffic control equipment, life support systems and safety devices)
- (8) Luxpia's liability for defective lamps shall be limited to replacement and in no event shall Luxpia be liable for consequential damage or lost profits.

14. Others

- (1) The warranties of quality set forth herein are exclusive. All previous negotiations and agreements not specifically incorporated herein are superseded and rendered null and void.
- (2) Both parties shall sincerely try to find a solution when any disagreement occurs regarding these specifications.
- (3) User shall not reverse engineer by disassembling or analysis of the LEDs without having prior written consent from Luxpia. When defective LEDs are found, the User shall inform Luxpia directly before disassembling or analysis.
- (4) These specifications can be revised upon mutual agreement.
- (5) Luxpia understands that the User accepts the content of these specifications, if the User does not return these specifications with signatures within 3 weeks after receipt.