

PA140

FEATURES

- MONOLITHIC MOS TECHNOLOGY
- LOW COST
- HIGH VOLTAGE OPERATION—350V, 250V DERATE
- LOW QUIESCENT CURRENT—2mA
- NO SECOND BREAKDOWN
- HIGH OUTPUT CURRENT—120 mA PEAK

APPLICATIONS

- TELEPHONE RING GENERATOR
- PIEZO ELECTRIC POSITIONING
- ELECTROSTATIC TRANSDUCER & DEFLECTION
- DEFORMABLE MIRROR FOCUSING
- PACKAGING OPTIONS

- 7T0-220 Plastic Package (PA140CD)
- 7T0-220 with staggered Lead Form (PA140CX)
- 7 DPAK Surface Mount Package (PA140CC)

DESCRIPTION

The PA140 is a high voltage monolithic MOSFET operational amplifier achieving performance features previously found only in hybrid designs while increasing reliability. Inputs are protected from excessive common mode and differential mode voltages. The safe operating area (SOA) has no second breakdown limitations. External compensation provides the user flexibility in choosing optimum gain and bandwidth for the application.

The PA140 is packaged in three standard package designs. The surface mount version of the PA140, the PA140CC, is an industry standard non-hermetic plastic 7-pin DPAK. The through hole versions of the PA140, the PA140CD, and the PA140CX, are industry standard non-hermetic plastic 7-pin TO-220 packages. The PA140CX is a staggered lead formed PA140CD and offers industry standard 100 mil spacing, this allows for easier PC board layout. (Please reference to the lead form datasheet drawing LF005 for package dimensions of the PA140CX.)

High voltage considerations should be taken when designing board layouts for the PA140. The PA140CD may require a derate in supply voltage depending on the spacing used for board layout. The 15-mil and 14-mil minimum spacing of the 7T0-220 and 7DDPAK respectively is adequate to standoff the 350V rating of the PA140. However, a supply voltage derate to 250V is required if the spacing of circuit board artwork is less than 11 mils. In cases where the PA140 is used to its maximum voltage rating, the PA140BP is recommended given that the staggered lead form allows for 100-mil standard spacing.

The monolithic amplifier is directly attached to the metal tabs of the PA140CC, PA140CD, and PA140CX. The metal tabs are directly tied to $-V_s$.

The PA140 is set for a gain of 38.5 boosting the 2.33V signal to 90V. The recommended compensation for gains above 30 is used. If capacitive loading is at least 330pF at all times, the recommended snubber network may be omitted.



TYPICAL APPLICATION

Ref Application Note 31 "Basic Op Amp Theory and Practice"

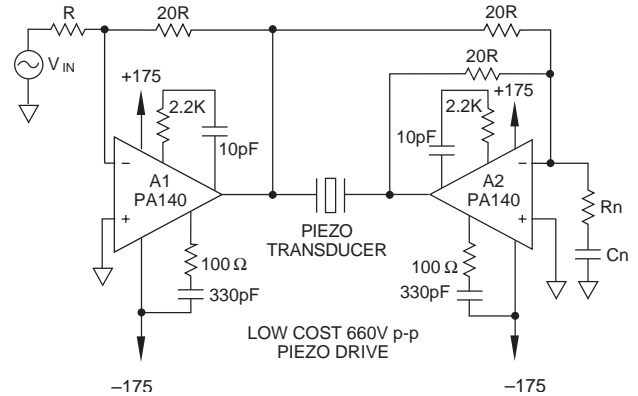

EXTERNAL CONNECTIONS

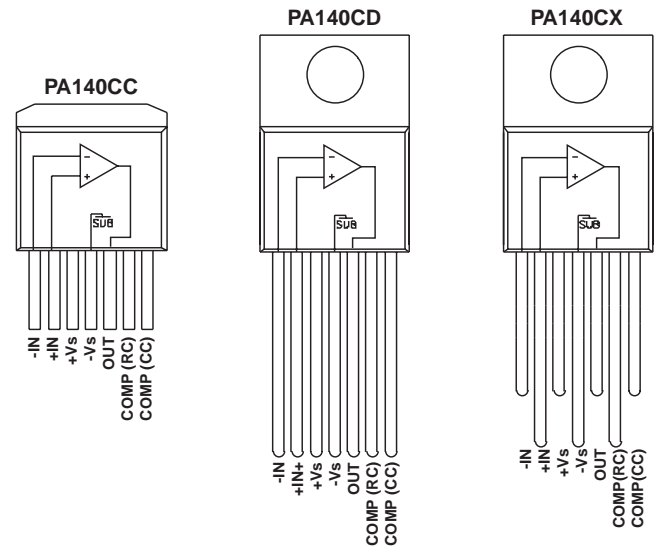

PHASE COMPENSATION

Gain	C_c	R_c
1	18pF	2.2K
10	10pF	2.2K
30	3.3pF	2.2K

C_s, C_c ARE RATED FOR FULL SUPPLY VOLTAGE. C_c IS NPO

$$R_{CL} = \frac{3}{I_{LIM}}$$

PA140

ABSOLUTE MAXIMUM RATINGS SPECIFICATIONS

ABSOLUTE MAXIMUM RATINGS

SUPPLY VOLTAGE, $+V_S$ to $-V_S$	350V
DERATED SUPPLY VOLTAGE $+V_S$ to $-V_S$	250V
OUTPUT CURRENT, continuous within SOA	60 mA
OUTPUT CURRENT, peak	120 mA
POWER DISSIPATION, continuous @ $T_c = 25^\circ\text{C}$	14W
INPUT VOLTAGE, differential	$\pm 16\text{ V}$
INPUT VOLTAGE, common mode	$\pm V_S$
TEMPERATURE, pin solder – 10 sec	220°C
TEMPERATURE, junction ²	150°C
TEMPERATURE, storage	-65 to $+150^\circ\text{C}$
TEMPERATURE RANGE, powered (case)	-40 to $+125^\circ\text{C}$

SPECIFICATIONS

PARAMETER	TEST CONDITIONS ¹	PA140			UNITS
		MIN	TYP	MAX	
INPUT					
OFFSET VOLTAGE, initial	Full temperature range		15	30	mV
OFFSET VOLTAGE, vs. temperature ⁴			70	130	$\mu\text{V}/^\circ\text{C}$
OFFSET VOLTAGE, vs supply			20	32	$\mu\text{V}/\text{V}$
OFFSET VOLTAGE, vs time			75		$\mu\text{V kh}$
BIAS CURRENT, initial			50	200	pA
BIAS CURRENT, vs supply			2	20	pA/V
OFFSET CURRENT, initial			50	200	pA
INPUT IMPEDANCE, DC			101^1		
INPUT CAPACITANCE			5		pF
COMMON MODE, voltage range		$\pm\text{VS}-12$			V
COMMON MODE REJECTION, DC	VCM = $\pm 90\text{V DC}$	84	94		dB
NOISE, broad band	10kHz BW, RS = 1K		50		$\mu\text{V RMS}$
NOISE, low frequency	1-10 Hz		110		$\mu\text{V p-p}$
GAIN					
OPEN LOOP at 15Hz	RL = 5K	94	106		dB
BANDWIDTH, open loop			1.6		MHz
POWER BANDWIDTH	CC = 10pf, 280V p-p		26		kHz
PHASE MARGIN	Full temperature range		60		°
OUTPUT					
VOLTAGE SWING	IO = 40mA	$\pm\text{VS}-12$	$\pm\text{VS}-10$		V
CURRENT, peak ⁵				120	mA
CURRENT, continuous		60			mA
SETTLING TIME to .1%	CC = 10pF, 10V step, AV = $_{-}10$		12		μs
SLEW RATE	CC = OPEN		40		V/ μs
CAPACITIVE LOAD	AV = +1	10			nF
RESISTANCE ⁶ , n° load	RCL = 0		150		
RESISTANCE ⁶ , 20 mA load	RCL = 0		25		
POWER SUPPLY					
VOLTAGE ³	See Note 3	± 50	± 150	± 175	V
CURRENT, quiescent			1.6	2.0	mA
THERMAL					
RESISTANCE, AC junction to case ⁶	F > 60Hz		5.9	6.85	$^\circ\text{C}/\text{W}$
RESISTANCE, DC junction to case ⁶	F < 60Hz		7.7	8.9	$^\circ\text{C}/\text{W}$
RESISTANCE, junction to air	Full temperature range				$^\circ\text{C}/\text{W}$
TEMPERATURE RANGE, case	Meets full range specifications	-25	25	+85	$^\circ\text{C}$

- NOTES: 1. Unless otherwise noted $T_c = 25^\circ\text{C}$, $C_c = 18\text{pF}$, $R_c = 2.2\text{K}$. DC input specifications are \pm value given. Power supply voltage is typical rating.
2. Long term operation at the maximum junction temperature will result in reduced product life. Derate internal power dissipation to achieve high MTTF.
3. Derate maximum supply voltage .5 V/ $^\circ\text{C}$ below case temperature of 25°C . No derating is needed above $TC = 25^\circ\text{C}$.
4. Sample tested by wafer to 95%.
5. Guaranteed but not tested.

CAUTION

The PA140 is constructed from MOSFET transistors. ESD handling procedures must be observed.

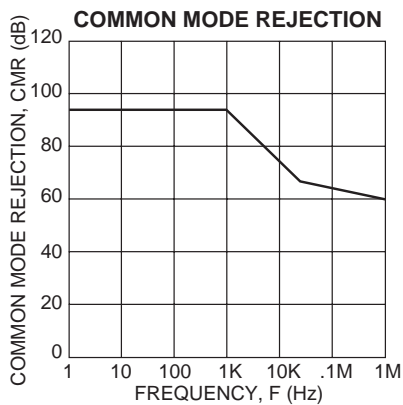
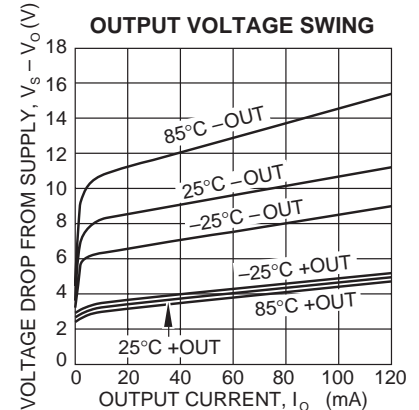
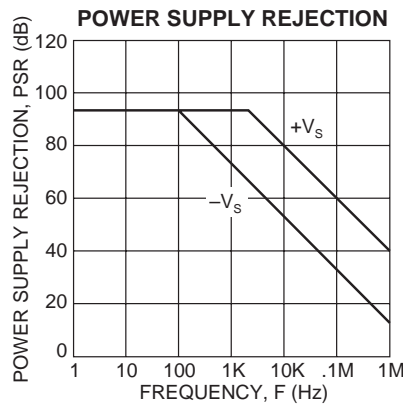
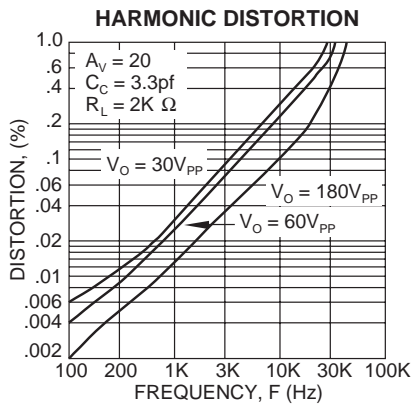
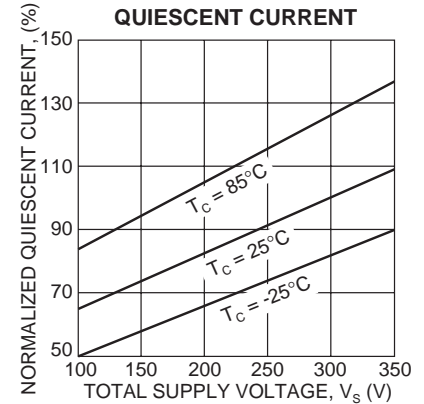
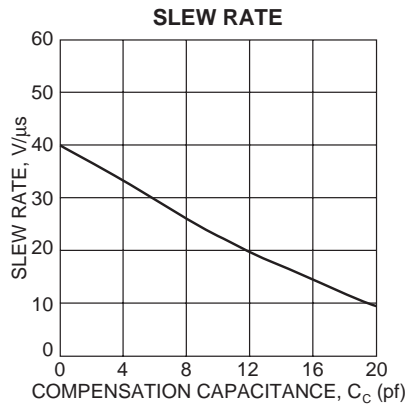
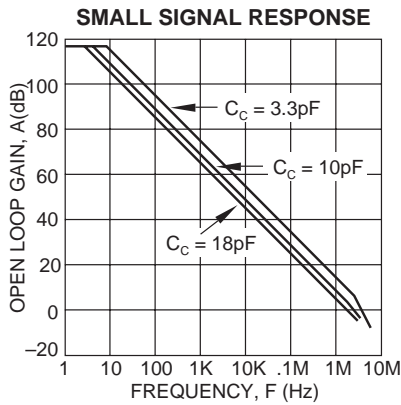
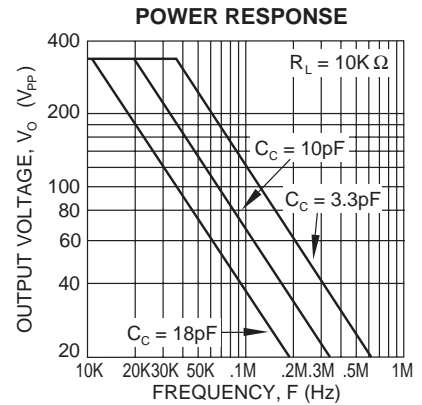
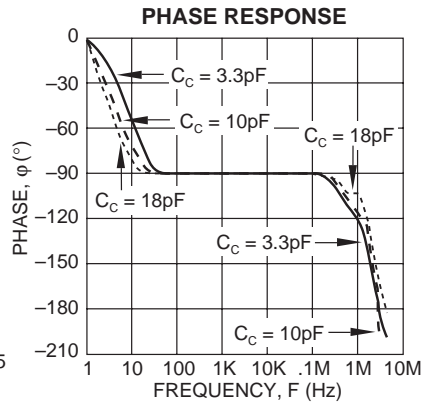
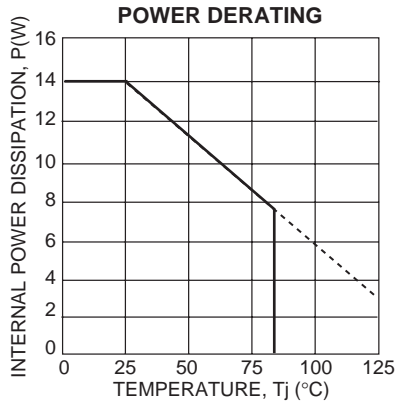

GENERAL

Please read Application Note 1 "General Operating Considerations" which covers stability, supplies, heat sinking, mounting, current limit, SOA interpretation, and specification interpretation. Visit www.apexmicrotech.com for design tools that help automate tasks.

INPUT PROTECTION

The PA140 inputs are protected against common mode voltages up the supply rails and differential voltages up to ± 16 volts as well as static discharge. Differential voltages exceeding 16 volts will be clipped by the protection circuitry. However, if more than a few milliamps of current is available from the overload source, the protection circuitry could be destroyed. The protection circuitry includes 300 ohm current limiting resistors at each input, but this may be insufficient for severe overloads. It may be necessary to add external resistors to the application circuit where severe overload conditions are expected. Limiting input current to 1mA will prevent damage.

STABILITY

The PA140 has sufficient phase margin when compensated for unity gain to be stable with capacitive loads of at least 10 nF. However, the low pass circuit created by the sumpoint (-in) capacitance and the feedback network may add phase shift and cause instabilities. As a general rule, the sumpoint load resistance (input and feedback resistors in parallel) should be 1K ohm or less at low gain settings (up to 10). Alternatively, use a bypass capacitor across the feedback resistor. The time constant of the feedback resistor and bypass capacitor combination should match the time constant of the sumpoint resistance and sumpoint capacitance.

The PA140 is externally compensated and performance can be tailored to the application. Use the graphs of small signal gain and phase response as well as the graphs for slew rate and power response as a guide. The compensation capacitor C_c must be rated at 350V. The compensation capacitor and associated resistor R_c must be mounted closely to the amplifier pins to avoid spurious oscillation. An NPO capacitor is recommended for compensation. The PA140 monolithic amplifier uses an all NMOS output topology that presents a special stability problem. An output snubber network of 330pF and 100 Ω in series from the output to $-V_s$ will eliminate this problem. This network is not required if the load capacitance is greater than 330pF.

MOUNTING

The PA140CC 7-pin DDPAK surface mountable package has a large exposed integrated copper heatslug to which the monolithic amplifier is directly attached. The PA140CC requires surface mount techniques of heatsinking. A solder connection to an area of 1 to 2 square inches of foil is recommended for circuit board layouts. This may be adequate heatsinking but the large number of variables involved suggests temperature measurements to be made on the top of the package. Surface mount techniques include the use of a surface mount fan in combination with a surface mount

heatsink on the backside of the FR4/PC board, or copper slug. Do not allow the temperature to exceed 85°C. The heatslug is tied internally to $-V_s$.

EQUIVALENT SCHEMATIC

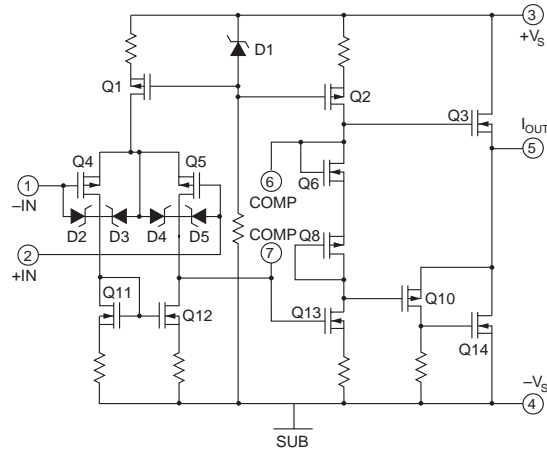

SAFE OPERATING AREA (SOA)

The MOSFET output stage of this power operational amplifier has two distinct limitations:

1. The current handling capability of the die metallization.
2. The temperature of the output MOSFETs.

NOTE: The output stage is protected against transient flyback. However, for protection against sustained, high energy flyback, external fast-recovery diodes should be used.

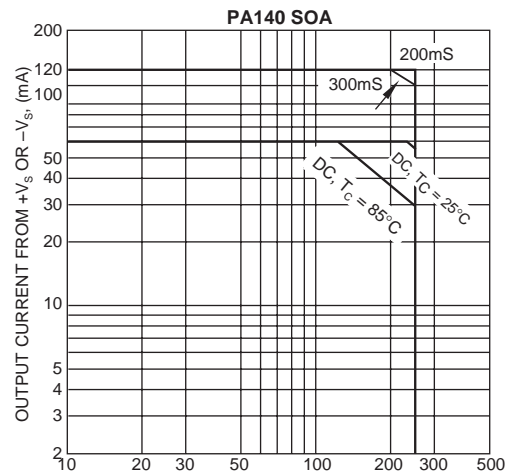

APPLICATION REFERENCES:

For additional technical information please refer to the following Application Notes:

- AN 01: General Operating Considerations
- AN 25: Driving Capacitive Loads
- AN 38: Loop Stability with Reactive Loads