

Silicon NPN Power Transistors

2SC3795 2SC3795A

DESCRIPTION

- With TO-220Fa package
- High breakdown voltage
- High speed switching
- Low collector saturation voltage

APPLICATIONS

- For high breakdown voltate ,high-speed switching applications

PINNING

PIN	DESCRIPTION
1	Base
2	Collector
3	Emitter

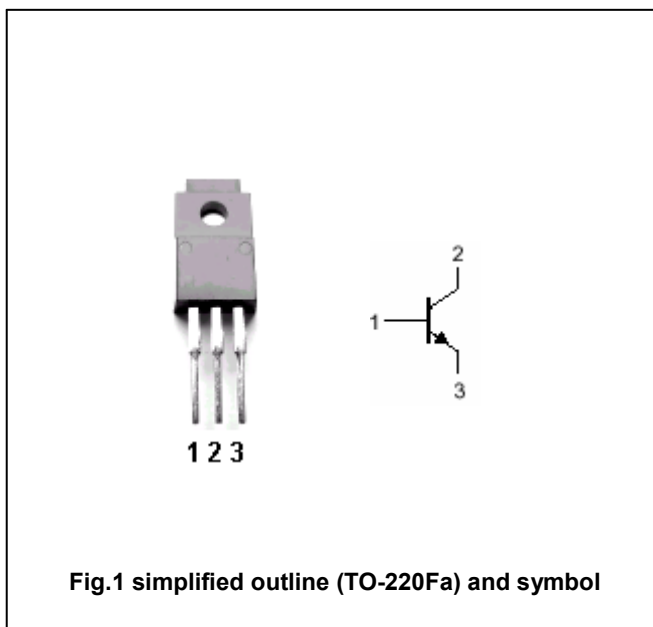

Absolute maximum ratings (Ta=25°C)

SYMBOL	PARAMETER	CONDITIONS	VALUE	UNIT
V _{CBO}	Collector-base voltage	2SC3795	800	V
		2SC3795A	900	
V _{CEO}	Collector-emitter voltage	Open base	500	V
V _{EBO}	Emitter-base voltage	Open collector	8	V
I _C	Collector current (DC)		5	A
I _{CM}	Collector current-Peak		10	A
I _B	Base current		3	A
P _C	Collector power dissipation	T _C =25°C	40	W
		T _a =25°C	2	
T _j	Junction temperature		150	°C
T _{stg}	Storage temperature		-55~150	°C

Silicon NPN Power Transistors

2SC3795 2SC3795A

CHARACTERISTICS

T_j=25 °C unless otherwise specified

SYMBOL	PARAMETER	CONDITIONS	MIN	TYP.	MAX	UNIT
V _{CEO(SUS)}	Collector-emitter sustaining voltage	I _C =0.2A, L=25mH	500			V
V _{CEsat}	Collector-emitter saturation voltage	I _C =3A; I _B =0.6A			1.0	V
V _{BEsat}	Base-emitter saturation voltage	I _C =3A; I _B =0.6A			1.5	V
I _{CBO}	Collector cut-off current	2SC3795			0.1	mA
		2SC3795A				
I _{EBO}	Emitter cut-off current	V _{EB} =5V; I _C =0			0.1	mA
h _{FE-1}	DC current gain	I _C =0.1A; V _{CE} =5V	15			
h _{FE-2}	DC current gain	I _C =3A; V _{CE} =5V	8			
f _T	Transition frequency	I _C =0.5A; V _{CE} =10V		8		MHz

Switching times

t _{on}	Turn-on time	2SC3795				1.0	μs
		2SC3795A				1.2	
t _s	Storage time		I _C =3A; I _{B1} =- I _{B2} =0.6A V _{CC} =200V			3.0	μs
t _f	Fall time	2SC3795				1.0	μs
		2SC3795A	1.2				

Silicon NPN Power Transistors

2SC3795 2SC3795A

PACKAGE OUTLINE

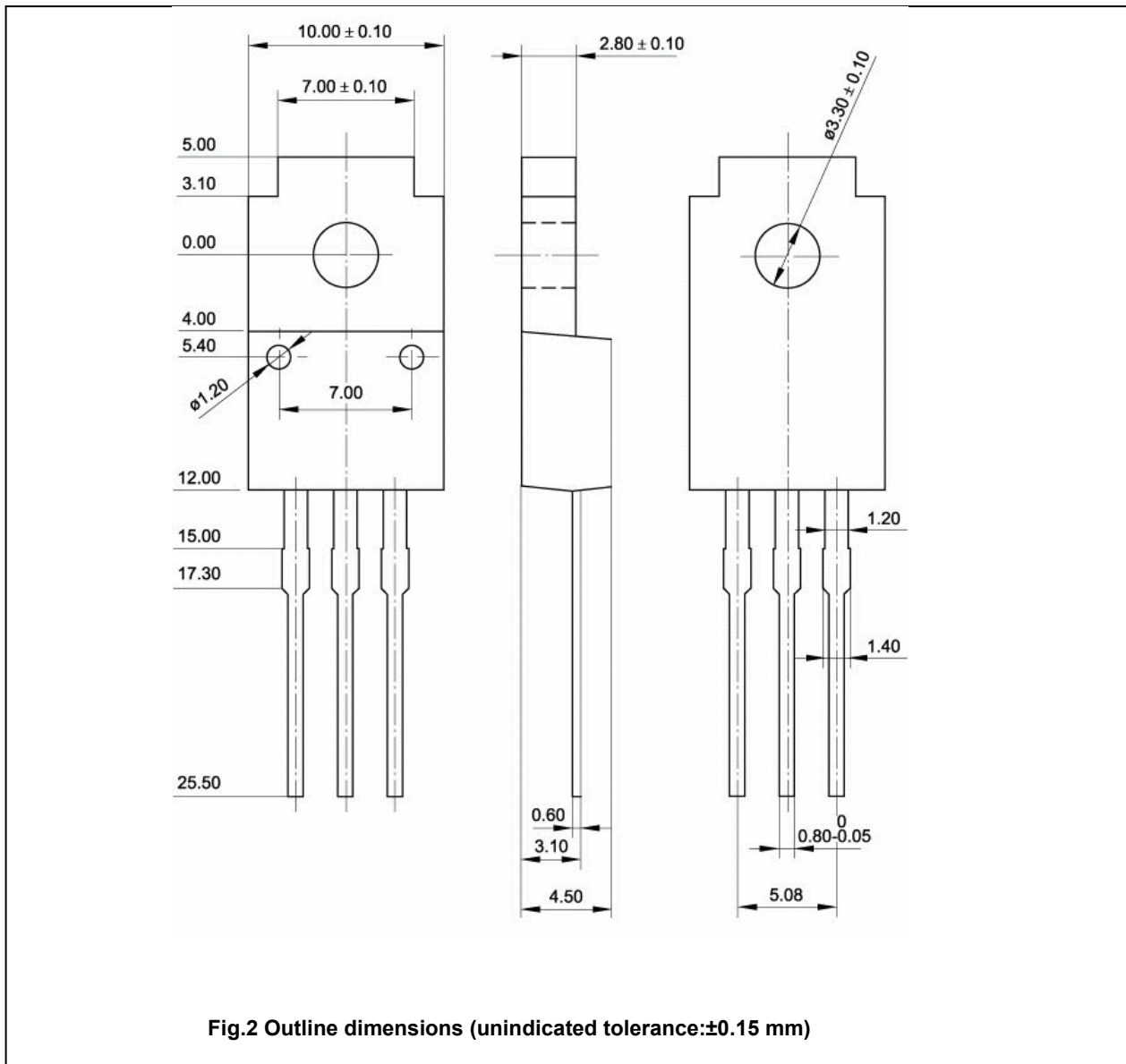

Silicon NPN Power Transistors

2SC3795 2SC3795A

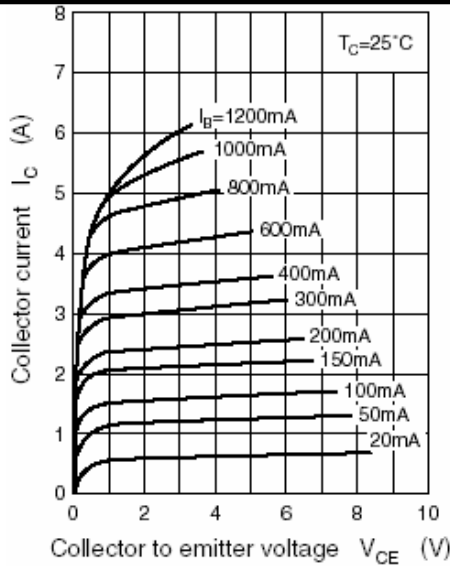

Fig.3 Static Characteristic

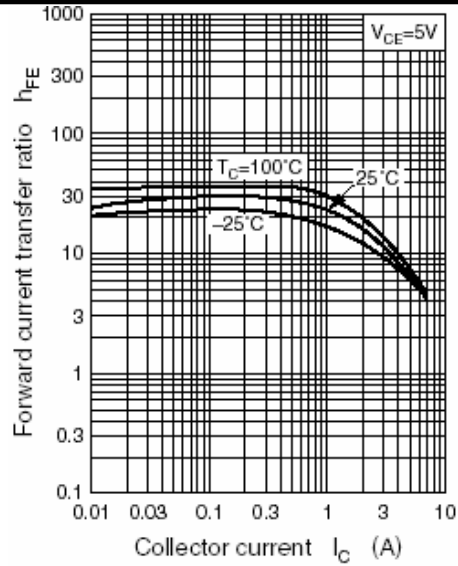

Fig.4 DC current Gain

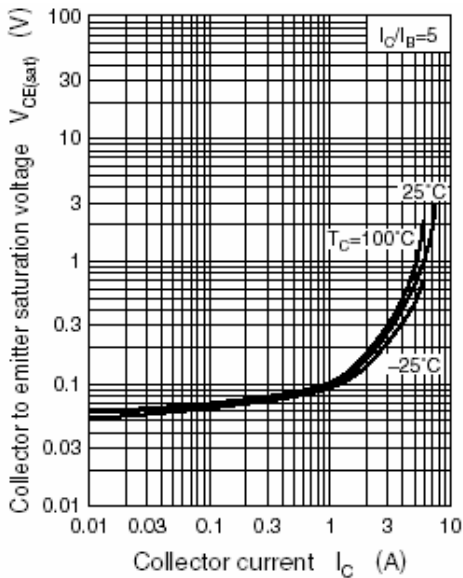

Fig.5 Collector-Emitter Saturation Voltage

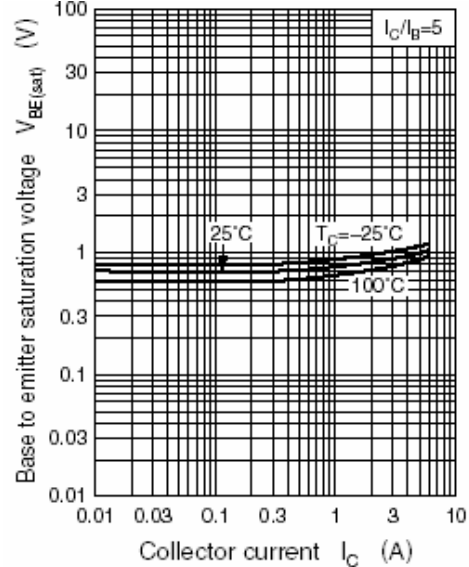

Fig.6 Base-Emitter Saturation Voltage

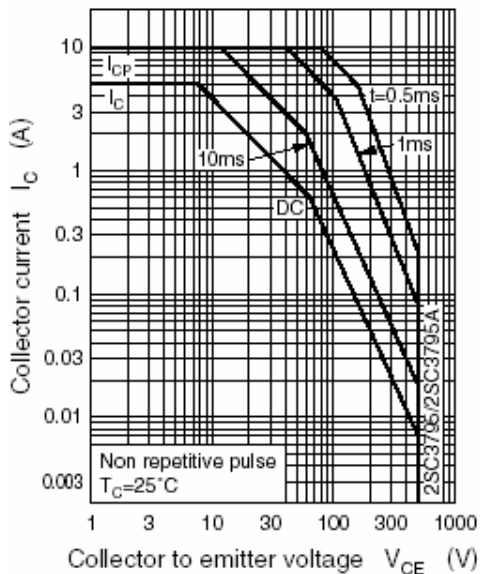

Fig.7 Safe Operating Area