



## Technical Data Sheet

### Mini Top View LEDs

**65-21/Y2C-CJ2L2X/3T**

#### Features

- White SMT package.
- Optical indicator.
- Wide viewing angle.
- Soldering methods: IR reflow soldering
- Available on tape and reel
- Pb-free
- The product itself will remain within RoHS compliant version.

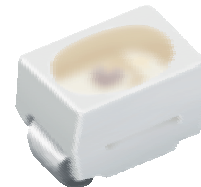

#### Descriptions

The 65-21 series is available in soft orange, green, blue, and yellow. Due to the package design, the LED has wide viewing angle and optimized light coupling by inter reflector. Besides, LED is mounted top down and emits through the PCB. This feature makes the ideal for light pipe application.

#### Applications

- Optical indicators.
- Coupling into light guides.
- Backlighting (LCD, cellular phones, switches, keys, displays, illuminated advertising, general lighting).
- Coupling into light guides; Interior automotive lighting (e.g. dashboard backlighting, etc.).

#### Device Selection Guide

Chip	Emitted Color	Resin Color
Material		
AlGaInP	Brilliant Yellow	Water Clear

**65-21/Y2C-CJ2L2X/3T**

**Package Outline Dimensions**

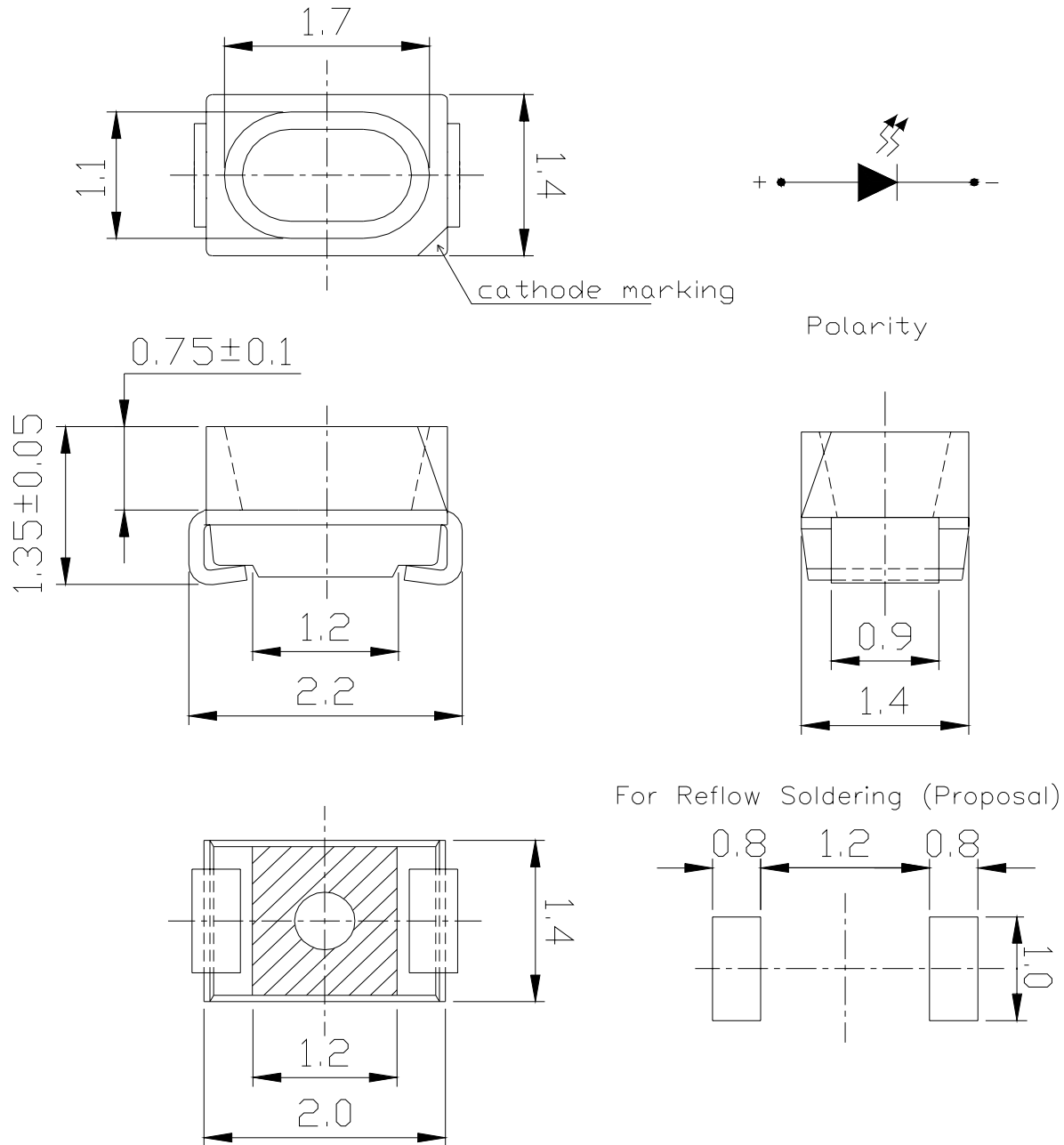

**Notes: Tolerance of Dimension : ±0.1mm. Unit = mm**

**65-21/Y2C-CJ2L2X/3T**
**Absolute Maximum Ratings (Ta=25 )**

Parameter	Symbol	Rating	Unit
Reverse Voltage	$V_R$	5	V
Forward Current	$I_F$	25	mA
Power Dissipation	$P_d$	60	mW
Peak Forward Current (Duty 1/10 @1KHz)	$I_{FP}$	60	mA
Electrostatic Discharge (HBM)	ESD	2000	V
Operating Temperature	$T_{opr}$	-40 ~ +85	
Storage Temperature	$T_{stg}$	-40 ~ +90	
Soldering Temperature	$T_{sol}$	Reflow Soldering : 260 for 10 sec. Hand Soldering : 350 for 3 sec.	

**Electro-Optical Characteristics (Ta=25 )**

Parameter	Symbol	Min.	Typ.	Max.	Unit	Condition
Luminous Intensity	$I_v$	5.8	-----	18.0	mcd	$I_F=2mA$
Viewing Angle	2 1/2	-----	120	-----	deg	$I_F=2mA$
Peak Wavelength	$\lambda_p$	-----	591	-----	nm	$I_F=2mA$
Dominant Wavelength	$\lambda_d$	586	-----	592	nm	$I_F=2mA$
Spectrum Radiation Bandwidth	$\Delta\lambda$	-----	15	-----	nm	$I_F=2mA$
Forward Voltage	$V_F$	-----	2.0	2.4	V	$I_F=2mA$
Reverse Current	$I_R$	-----	-----	10	$\mu A$	$V_R=5V$

**Notes:**

1. Tolerance of Luminous Intensity  $\pm 11\%$
2. Tolerance of Dominant Wavelength  $\pm 1nm$

**65-21/Y2C-CJ2L2X/3T****Bin Range of Dominant Wavelength**

Bin Code	Min	Max	Unit	Condition
1	586	589	nm	I <sub>F</sub> =2mA
2	589	592		

**Bin Range of Luminous Intensity**

Bin Code	Min.	Max.	Unit	Condition
J2	5.8	7.2	mcd	I <sub>F</sub> =2mA
K1	7.2	9.0		
K2	9.0	11.5		
L1	11.5	14.5		
L2	14.5	18.0		

**65-21/Y2C-CJ2L2X/3T**

**Typical Electro-Optical Characteristics Curves**

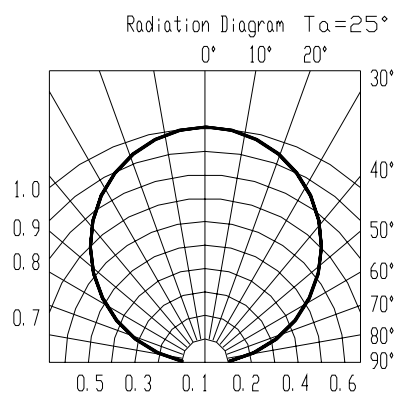
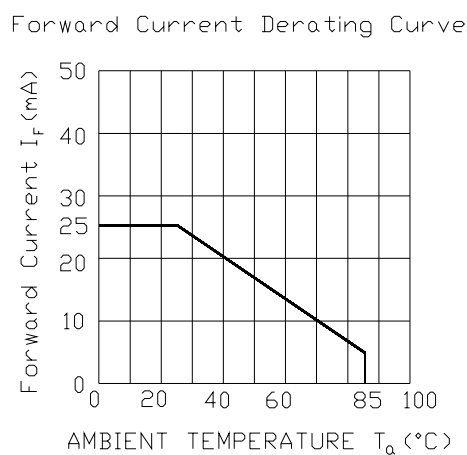
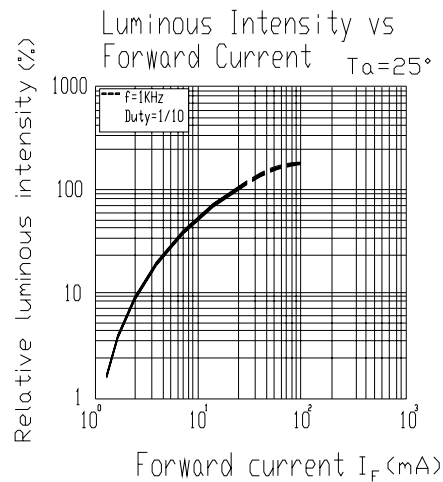
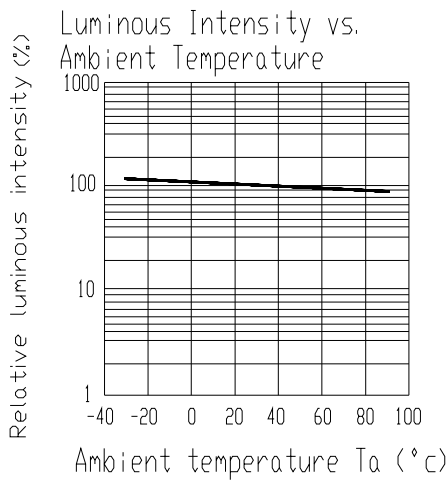
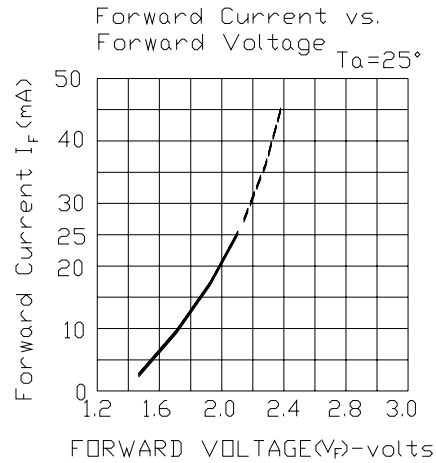
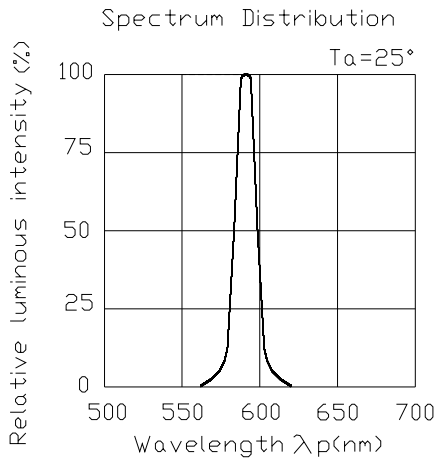

**65-21/Y2C-CJ2L2X/3T**

**Packing specification**

Label explanation

- (1) CPN : Customer's Production Number
- (2) P/N : Production Number
- (3) QTY : Packing Quantity
- (4) CAT : Luminous Intensity Rank
- (5) HUE : Dom. Wavelength Rank
- (6) REF : Forward Voltage Rank
- (7) LOT No : Lot Number

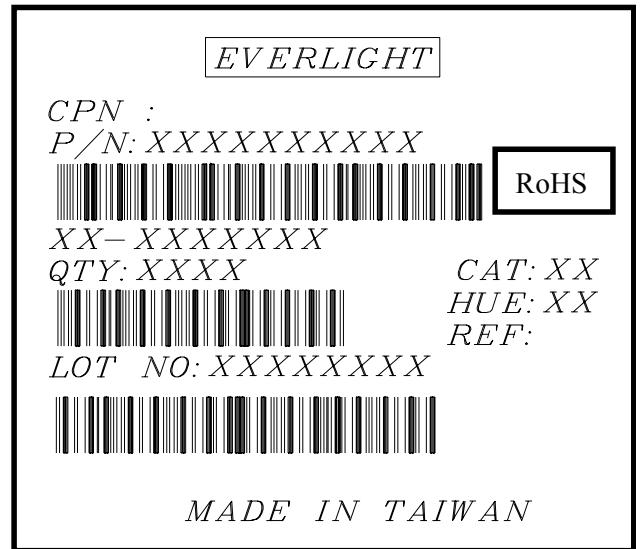

Reel Dimensions

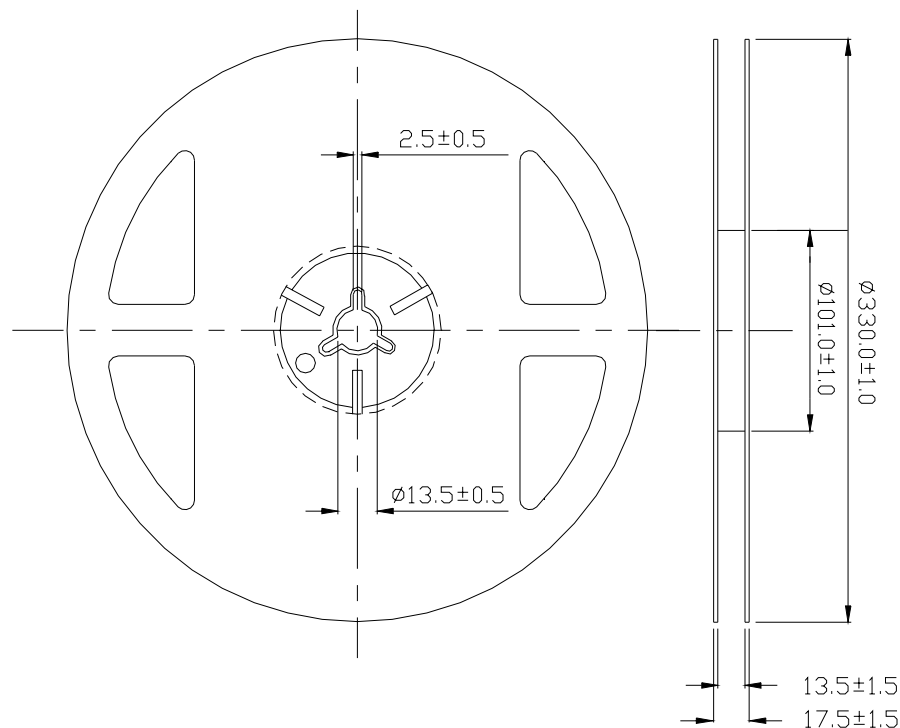

**Note :** Tolerances unless dimension ±0.1mm. Unit = mm

**65-21/Y2C-CJ2L2X/3T**

Carrier Tape Dimensions; Loaded quantity per reel 3000 PCS/reel

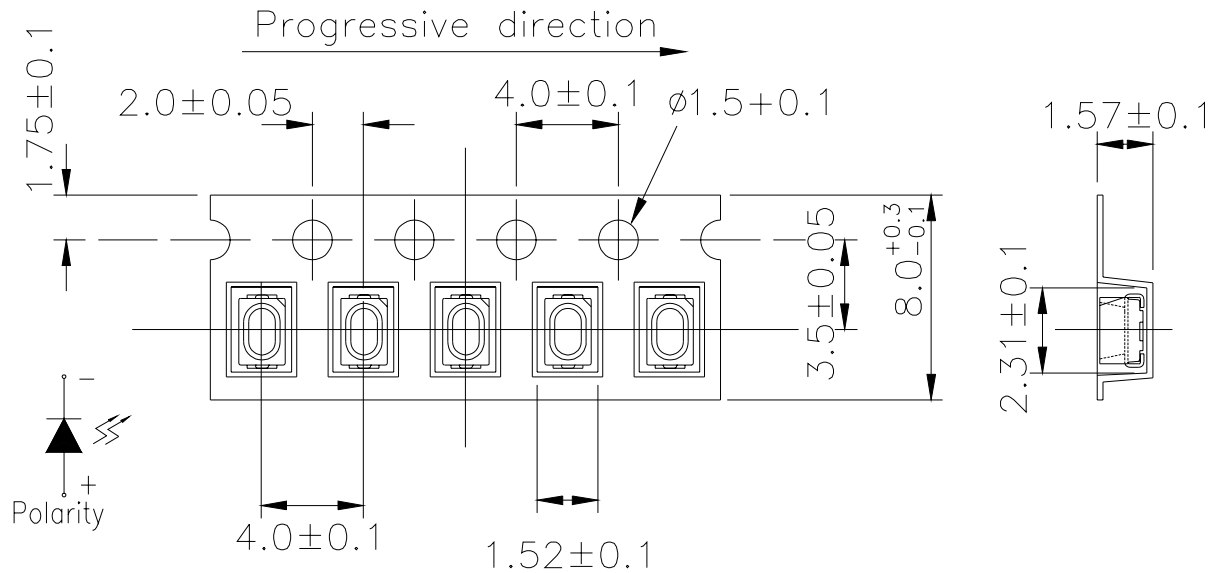

**Note:** The tolerances unless mentioned is  $\pm 0.1$ mm ,Unit = mm

**Moisture Resistant Packaging**

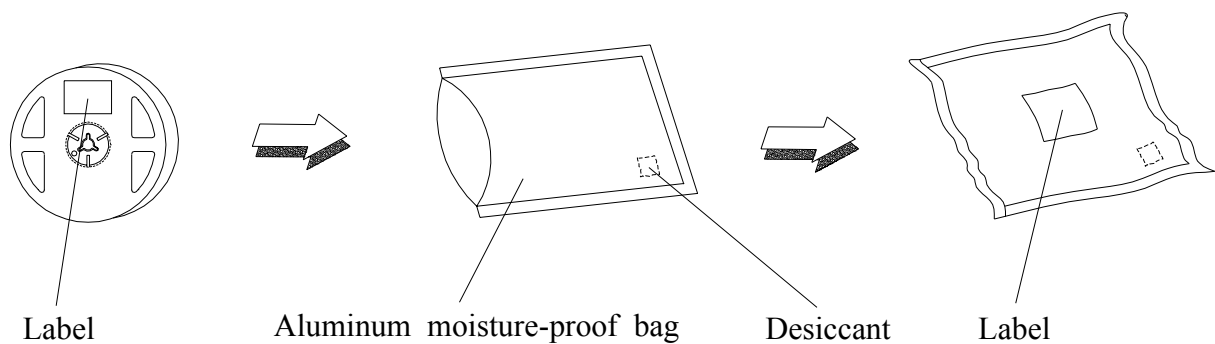

**65-21/Y2C-CJ2L2X/3T**

**Reliability Test Items and Conditions**

The reliability of products shall be satisfied with items listed below.

Confidence level : 90%

LTPD : 10%

No.	Items	Test Condition	Test Hours/Cycles	Sample Size	Ac/Re
1	Reflow Soldering	Temp. : 260 ±5 Min. 5sec.	6 min	22 PCS.	0/1
2	Temperature Cycle	H : +100 15min ∫ 5 min L : -40 15min	300 Cycles	22 PCS.	0/1
3	Thermal Shock	H : +100 5min ∫ 10 sec L : -10 5min	300 Cycles	22 PCS.	0/1
4	High Temperature Storage	Temp. : 100	1000 Hrs.	22 PCS.	0/1
5	Low Temperature Storage	Temp. : -40	1000 Hrs.	22 PCS.	0/1
6	DC Operating Life	I <sub>F</sub> = 20 mA	1000 Hrs.	22 PCS.	0/1
7	High Temperature / High Humidity	85 / 85%RH	1000 Hrs.	22 PCS.	0/1



**Precautions for Use**

1. Over-current-proof

Customer must apply resistors for protection, otherwise slight voltage shift will cause big current change ( Burn out will happen ).

2. Storage

2.1 Do not open moisture proof bag before the products are ready to use.

2.2 Before opening the package: The LEDs should be kept at 30 or less and 90%RH or less.

2.3 After opening the package: The LED's floor life is 1 year under 30 or less and 60% RH or less. If unused LEDs remain, it should be stored in moisture proof packages.

2.4 If the moisture absorbent material (silica gel) has faded away or the LEDs have exceeded the storage time, baking treatment should be performed using the following conditions.

Baking treatment: 60±5 for 24 hours.

3. Soldering Condition

3.1 Pb-free solder temperature profile

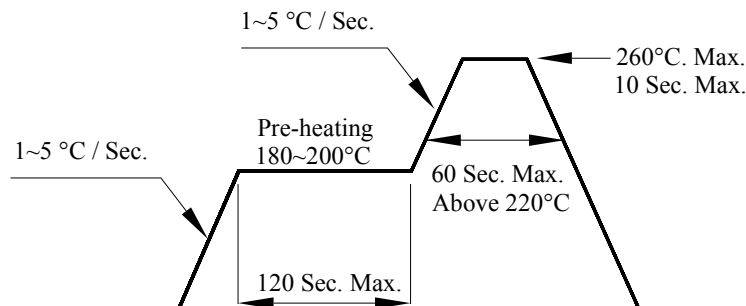

3.2 Reflow soldering should not be done more than two times.

3.3 When soldering, do not put stress on the LEDs during heating.

3.4 After soldering, do not warp the circuit board.

4. Soldering Iron

Each terminal is to go to the tip of soldering iron temperature less than 350 for 3 seconds within once in less than the soldering iron capacity 25W. Leave two seconds and more intervals, and do soldering of each terminal. Be careful because the damage of the product is often started at the time of the hand solder.

### 5. Repairing

Repair should not be done after the LEDs have been soldered. When repairing is unavoidable, a double-head soldering iron should be used (as below figure). It should be confirmed beforehand whether the characteristics of the LEDs will or will not be damaged by repairing.

