

RoHS Compliant Product

A suffix of "-C" specifies halogen & lead-free

**FEATURES**

- Ultra-Small Surface Mount Package
- Fast Switching
- PN Junction Guard Ring for Transient and ESD Protection

**MECHANICAL DATA**

- Case: SOT-523, Molded Plastic
- Terminals: Solderable per MIL-STD-202, Method 208
- Polarity: See Diagrams Below
- Weight: 0.004 grams (approx.)
- Mounting Position: Any

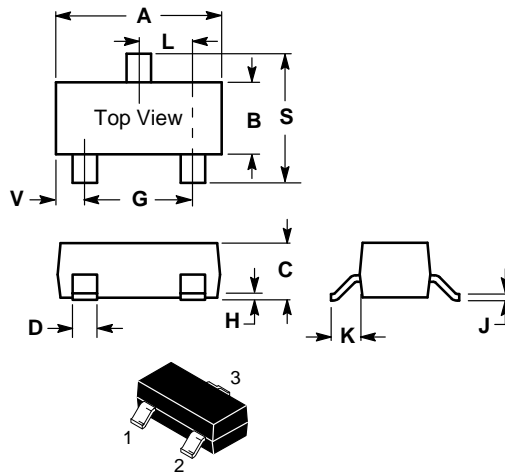

SOT-523		
Dim	Min	Max
A	1.500	1.700
B	0.780	0.820
C	0.800	0.820
D	0.280	0.320
G	0.900	1.100
H	0.000	0.100
J	0.100	0.200
K	0.350	0.410
L	0.490	0.510
S	1.500	1.700
V	0.280	0.320
All Dimension in mm		

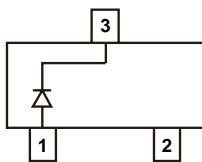

BAT54T Marking: L1

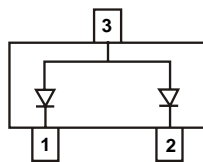

BAT54AT Marking: L2

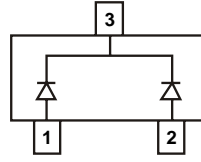

BAT54CT Marking: L3

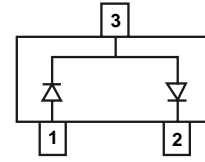

BAT54ST Marking: L4

**MAXIMUM RATINGS** ( $T_J = 125^\circ\text{C}$  unless otherwise noted)

Rating	Symbol	Value	Unit
Reverse Voltage	$V_R$	30	Volts
Forward Power Dissipation @ $T_A = 25^\circ\text{C}$ Derate above $25^\circ\text{C}$	$P_F$	150 4.2	mW mW/ $^\circ\text{C}$
Forward Current (DC)	$I_F$	200 Max	mA
Junction Temperature	$T_J$	125 Max	$^\circ\text{C}$
Storage Temperature Range	$T_{stg}$	-55 to +150	$^\circ\text{C}$

**ELECTRICAL CHARACTERISTICS** ( $T_A = 25^\circ\text{C}$  unless otherwise noted) (EACH DIODE)

Characteristic	Symbol	Min	Typ	Max	Unit
Reverse Breakdown Voltage ( $I_R = 10 \mu\text{A}$ )	$V_{(BR)R}$	30	—	—	Volts
Total Capacitance ( $V_R = 1.0 \text{ V}$ , $f = 1.0 \text{ MHz}$ )	$C_T$	—	7.6	10	pF
Reverse Leakage ( $V_R = 25 \text{ V}$ )	$I_R$	—	0.5	2.0	$\mu\text{A}_{dc}$
Forward Voltage ( $I_F = 0.1 \text{ mAdc}$ )	$V_F$	—	0.22	0.24	Vdc
Forward Voltage ( $I_F = 1.0 \text{ mAdc}$ )	$V_F$	—	0.29	0.32	Vdc
Forward Voltage ( $I_F = 10 \text{ mAdc}$ )	$V_F$	—	0.35	0.40	Vdc
Reverse Recovery Time ( $I_F = I_R = 10 \text{ mAdc}$ , $I_{R(REC)} = 1.0 \text{ mAdc}$ ) Figure 1	$t_{rr}$	—	—	5.0	ns
Forward Voltage ( $I_F = 30 \text{ mAdc}$ )	$V_F$	—	0.41	0.50	Vdc
Forward Voltage ( $I_F = 100 \text{ mAdc}$ )	$V_F$	—	0.52	1.00	Vdc
Forward Current (DC)	$I_F$	—	—	200	mAdc
Repetitive Peak Forward Current	$I_{FRM}$	—	—	200	mAdc
Non-Repetitive Peak Forward Current ( $t < 1.0 \text{ s}$ )	$I_{FSM}$	—	—	400	mAdc

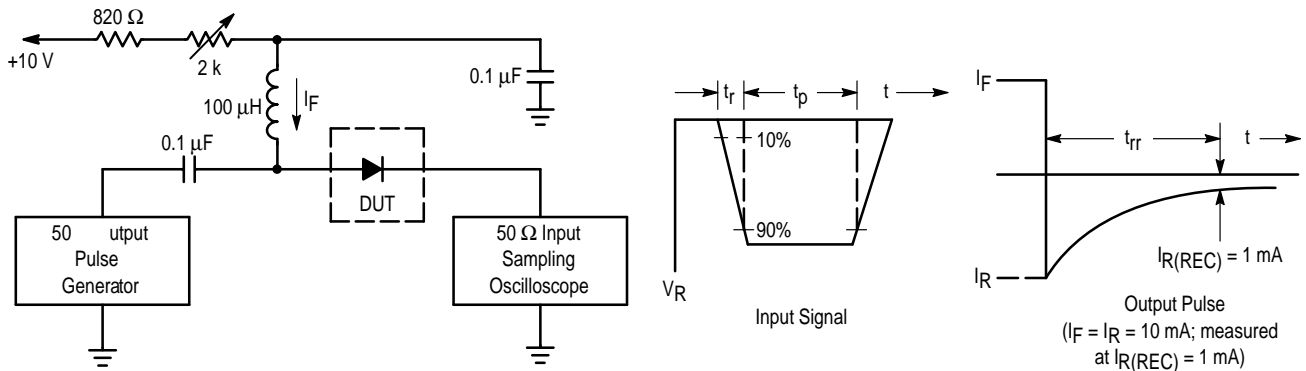

- Notes: 1. A 2.0 kΩ variable resistor adjusted for a Forward Current ( $I_F$ ) of 10 mA.  
2. Input pulse is adjusted so  $I_{R(peak)}$  is equal to 10 mA.  
3.  $t_p \gg t_{rr}$

**Figure 1. Recovery Time Equivalent Test Circuit**

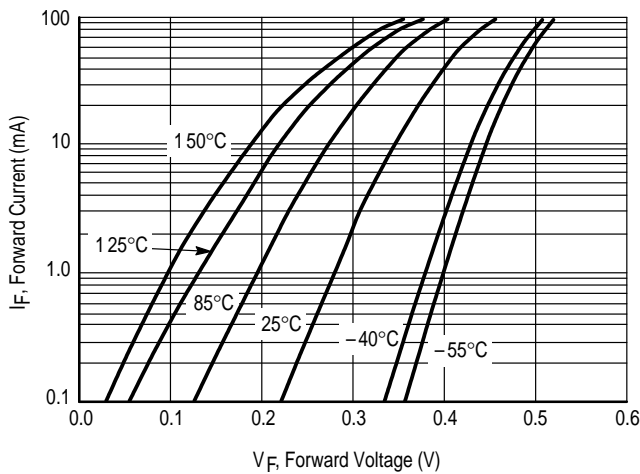

**Figure 2. Forward Voltage**

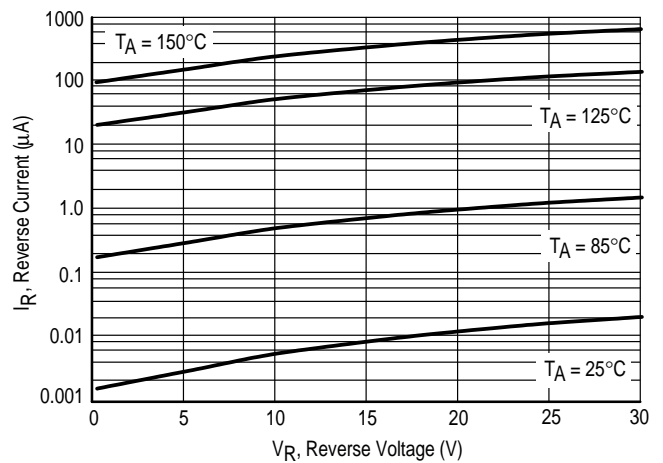

**Figure 3. Leakage Current**

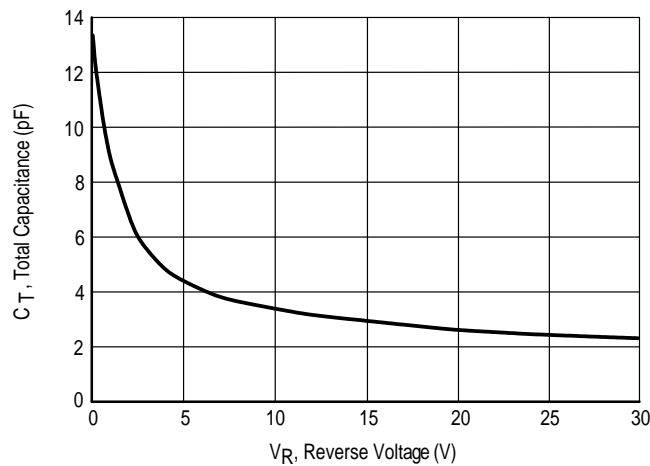

**Figure 4. Total Capacitance**