

1.0A Low Dropout Positive Voltage Regulator

IL2940CT-xx

General Description

- Maximum output current up to 1A
- Dropout voltage less than 0.8V at load current 1A
- Internal limitation of short circuit current
- Built-in overheat protection
- Protection from reverse polarity installation

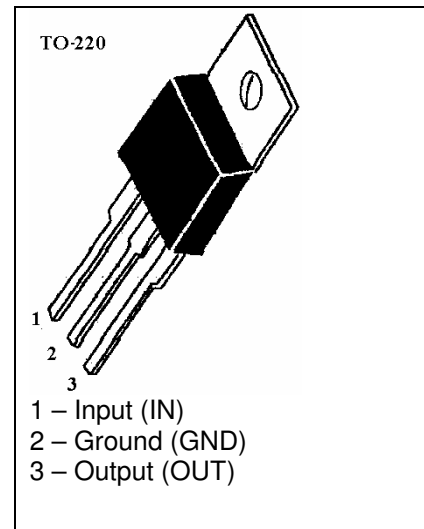

Absolute Maximum Ratings

Parameter	Symbol	Value	Unit
Maximum Line Transient ($T \leq 1\text{ms}$, $R_0 = 100\ \Omega$)	V_{MIN}	45	V
Reverse Polarity Transient Input Voltage ($T \leq 1\text{ms}$, $R_0 = 100\ \Omega$)	V_{MIN}	-45	V
Reverse Polarity DC Input Voltage ($R_0 = 100\ \Omega$)	V_{MIN}	-15	V
Maximum Junction Temperature	T_J	150	$^{\circ}\text{C}$
Thermal Resistance Junction-to-Case	R_{θ}	3	$^{\circ}\text{C}/\text{W}$
Thermal Resistance Junction-to-Ambient	R_{θ}	62	$^{\circ}\text{C}/\text{W}$
Working Temperature Range	T_C	-10 ~ 125	$^{\circ}\text{C}$

Application Circuit

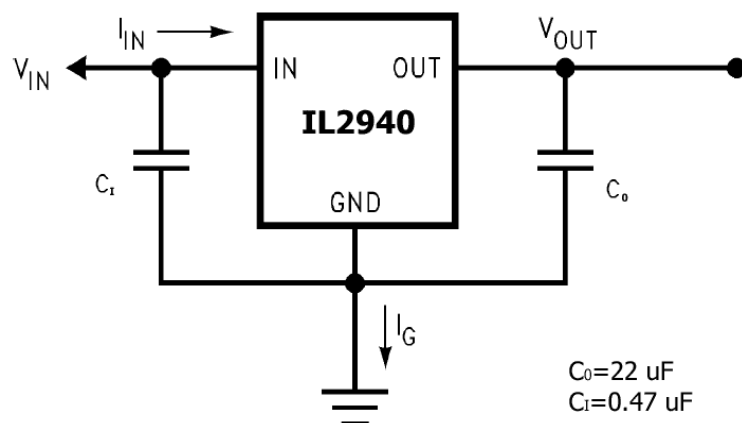

IL2940CT-5V ELECTRICAL CHARACTERISTICS

Parameter	Symbol	Test Conditions	Norm		Chip Temperature
			min	max	
Output Voltage, V	V_0	$6.25V \leq V_{IN} \leq 26V$ $5mA \leq I_0 \leq 1A$	4.85	5.15	25±10 °C
			4.75	5.25	-10 ~ 125 °C
Dropout Voltage, V	V_{DS}	$I_0 = 1A$		0.8	25±10 °C
				1.0	-10 ~ 125 °C
		$I_0 = 100mA$		0.15	25±10 °C
				0.2	-10 ~ 125 °C
Line Regulation, mV	$\Delta V_{0(V)}$	$7V \leq V_{IN} \leq 26V$ $I_0 = 5mA$		50	25±10 °C
Load Regulation, mV	$\Delta V_{0(I)}$	$50mA \leq I_0 \leq 1A$ $V_{IN} = 10V$		50	
Short Circuit Current, A	I_{OS}	$V_0 = 0V, V_{IN} = 10V$	1.6		
Quiescent Current, mA	I_{CC}	$7V \leq V_{IN} \leq 26V$ $I_0 = 5mA$		15	25±10 °C
		$I_0 = 1A, V_{IN} = 10V$		45	25±10 °C
					60
Ripple Rejection, dB	RR	$f_0=120Hz, V_{IN}=10V$ $I_0 = 100mA, V_{i\sim}=1V$	60		25±10 °C

NOTES

1. All parameters are tested with input capacitor $C_I=0,47\mu F$ and output capacitor $C_O=22\mu F$
2. Line Regulation and Load Regulation are guaranteed for constant junction temperature. Impulse equipment should be used to exclude temperature drift effects.

IL2940CT-12V ELECTRICAL CHARACTERISTICS

Parameter	Symbol	Test Conditions	Norm		Chip Temperature
			min	max	
Output Voltage, V	V_0	$13.6V \leq V_{IN} \leq 26V$ $5mA \leq I_0 \leq 1A$	11.64	12.36	25±10 °C
			11.4	12.6	-10 ~ 125 °C
Dropout Voltage, V	V_{DS}	$I_0 = 1A$		0.8	25±10 °C
				1.0	-10 ~ 125 °C
		$I_0 = 100mA$		0.15	25±10 °C
				0.2	-10 ~ 125 °C
Line Regulation, mV	$\Delta V_{0(V)}$	$14V \leq V_{IN} \leq 26V$ $I_0 = 5mA$		120	25±10 °C
Load Regulation, mV	$\Delta V_{0(I)}$	$5mA \leq I_0 \leq 1A$ $V_{IN} = 17V$		120	
Short Circuit Current, A	I_{OS}	$V_0 = 0V, V_{IN} = 17V$	1.6		
Quiescent Current, mA	I_{CC}	$14V \leq V_{IN} \leq 26V$ $I_0 = 5mA$		15	25±10 °C
		$I_0 = 1A, V_{IN} = 17V$		45	25±10 °C
					60
Ripple Rejection, dB	RR	$f_0=120Hz, V_{IN}=17V$ $I_0 = 100mA, V_{i\sim}=1V$	54		25±10 °C

NOTES

3. All parameters are tested with input capacitor $C_I=0,47\mu F$ and output capacitor $C_O=22\mu F$
4. Line Regulation and Load Regulation are guaranteed for constant junction temperature. Impulse equipment should be used to exclude temperature drift effects.

Typical Performance Characteristics

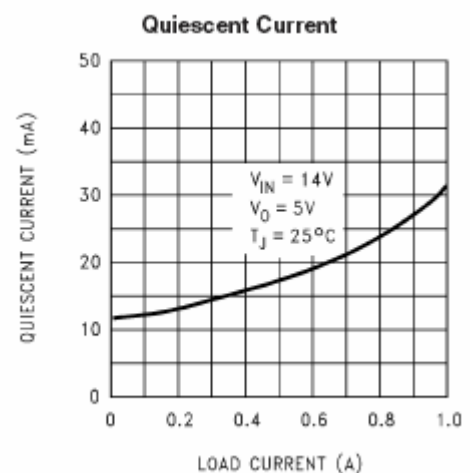
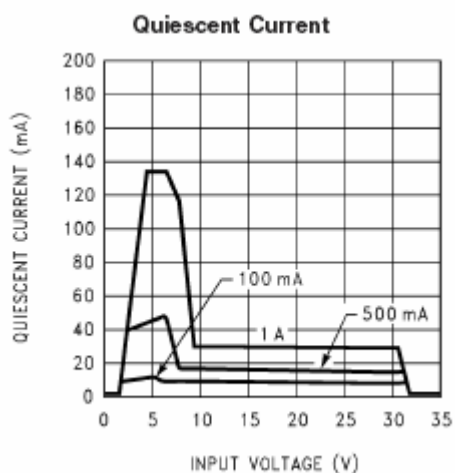
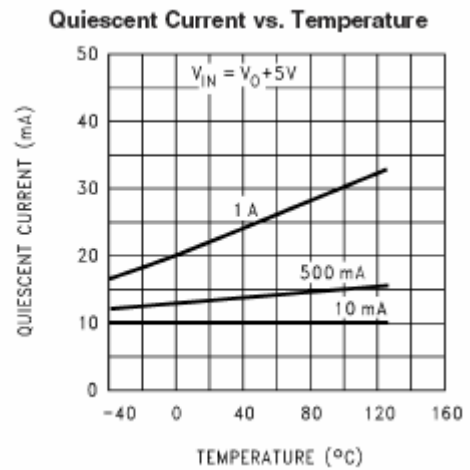
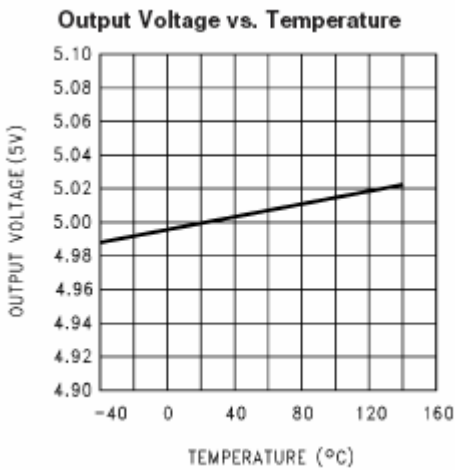
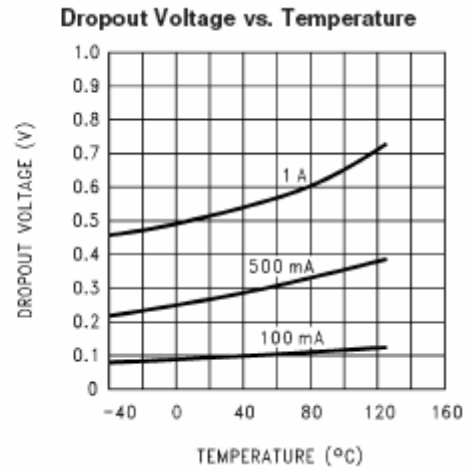
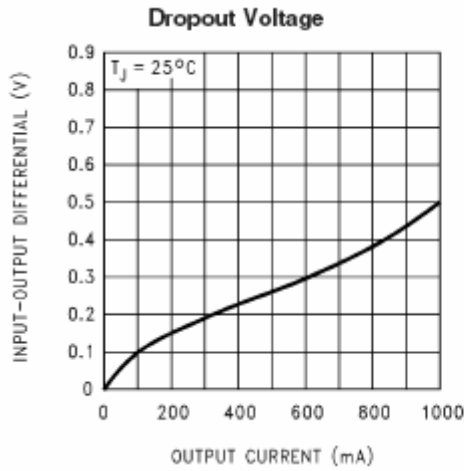

Typical Performance Characteristics (Continued)

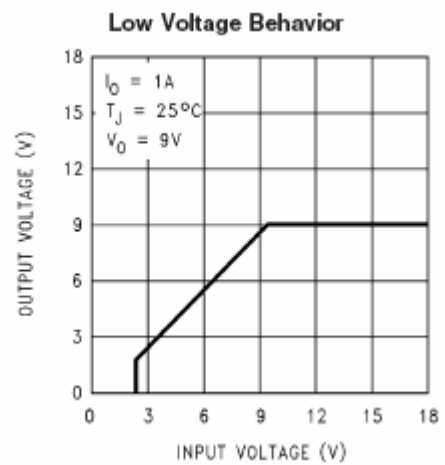
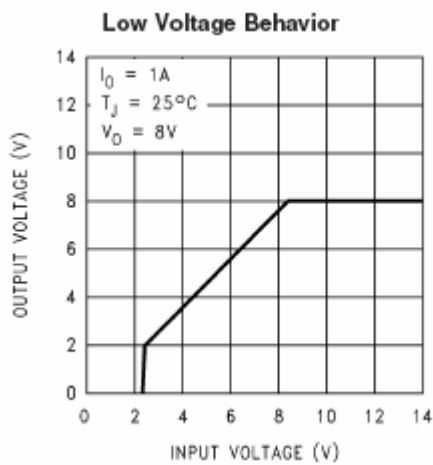
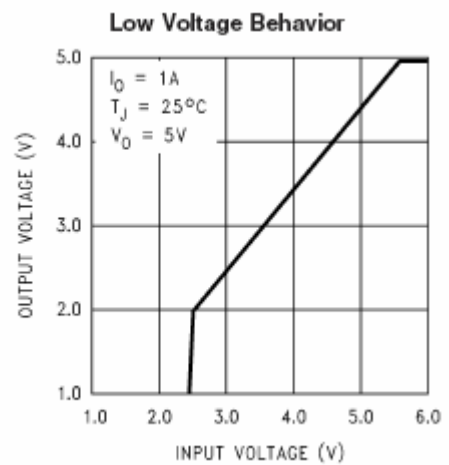
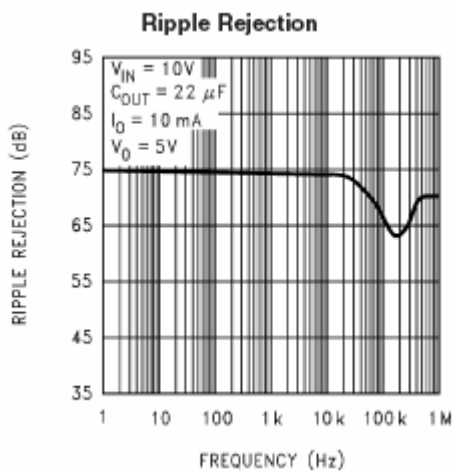
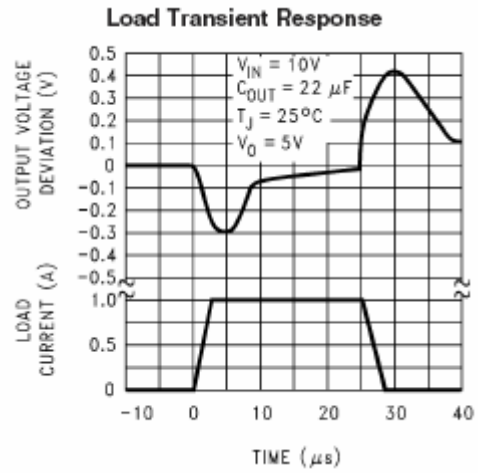
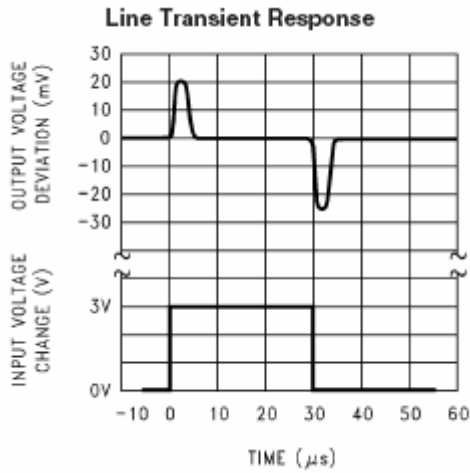

Typical Performance Characteristics (Continued)

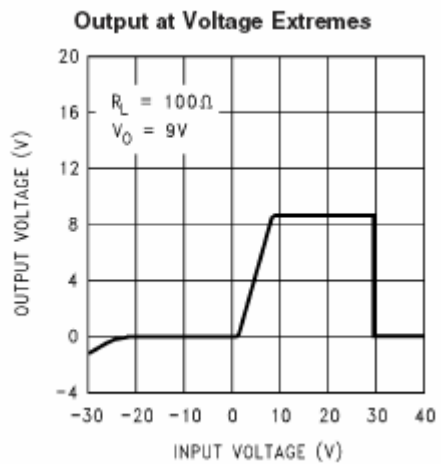
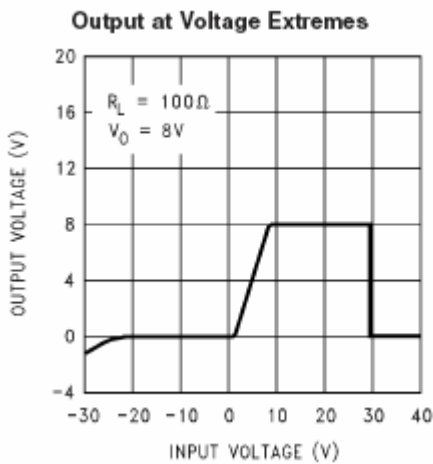
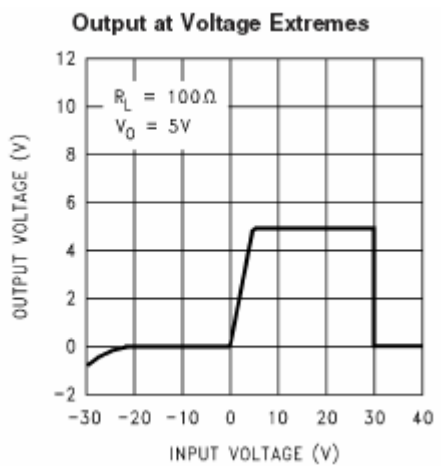
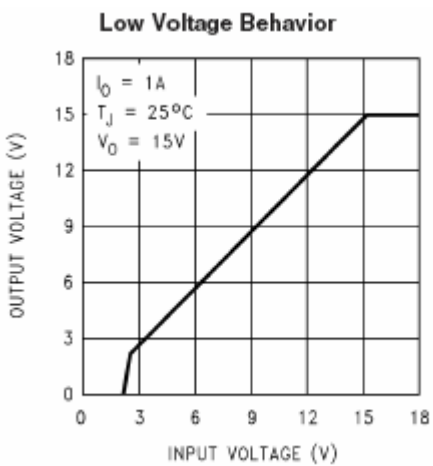
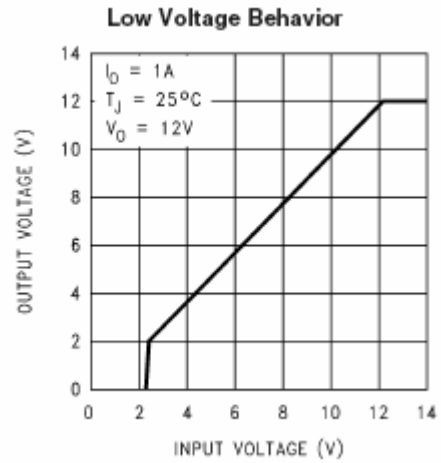
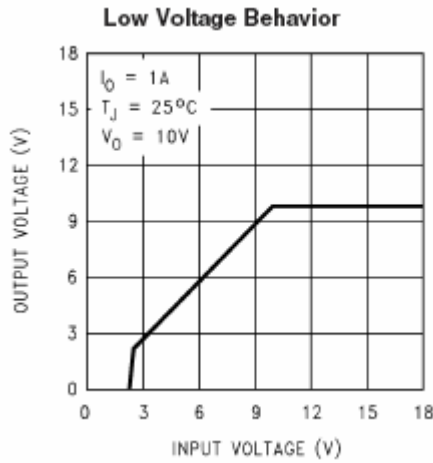

Typical Performance Characteristics (Continued)

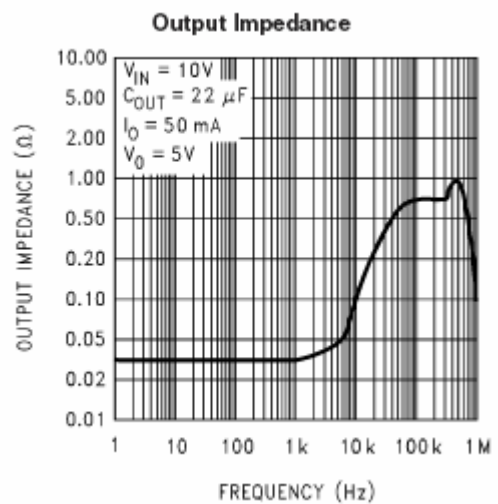
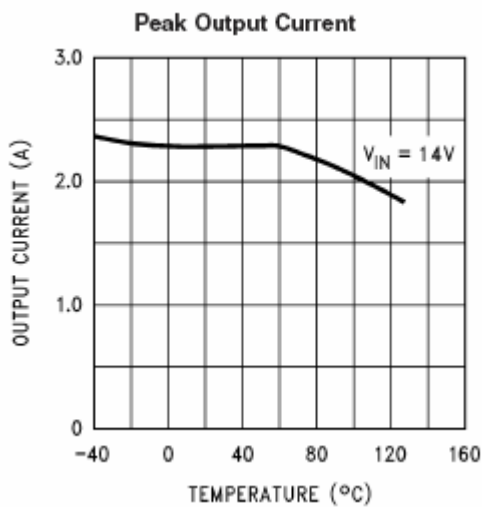
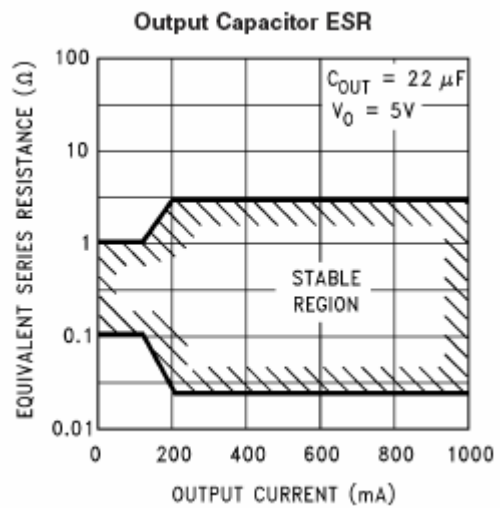
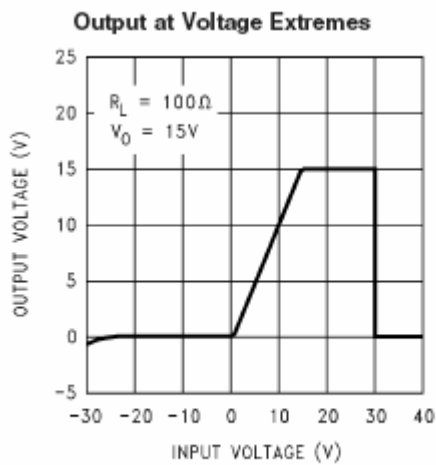
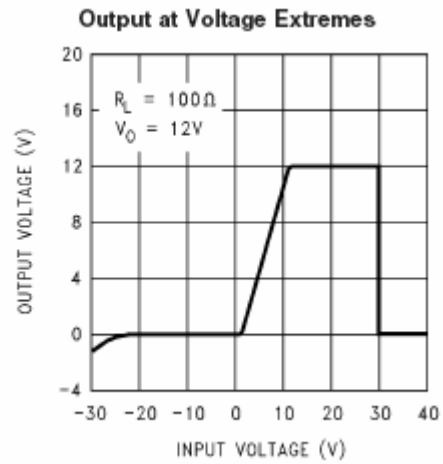
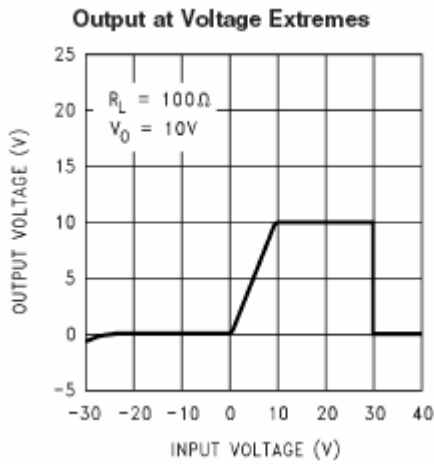

Typical Performance Characteristics (Continued)

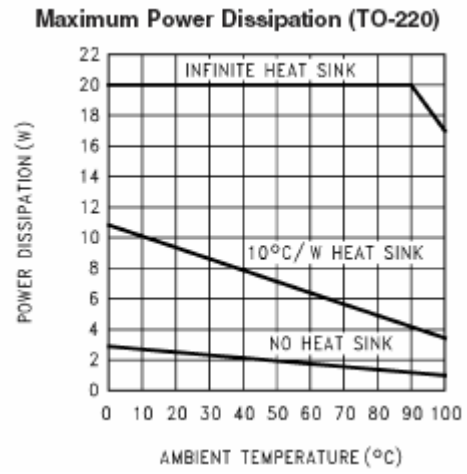

PKG OUTLINE DIMENSIONS

TO-220AB

