

FEATURES

- Ranges 0...±30 to 0...±1000 sccm¹ or 0...±4 "H₂O (0...±10 mbar)
- Bidirectional sensing
- Actual mass flow sensing
- Low differential pressure sensing

SERVICE

To be used with dry gases only

The AWM series is NOT designed for liquid flow and will be damaged by liquid flow through the sensor

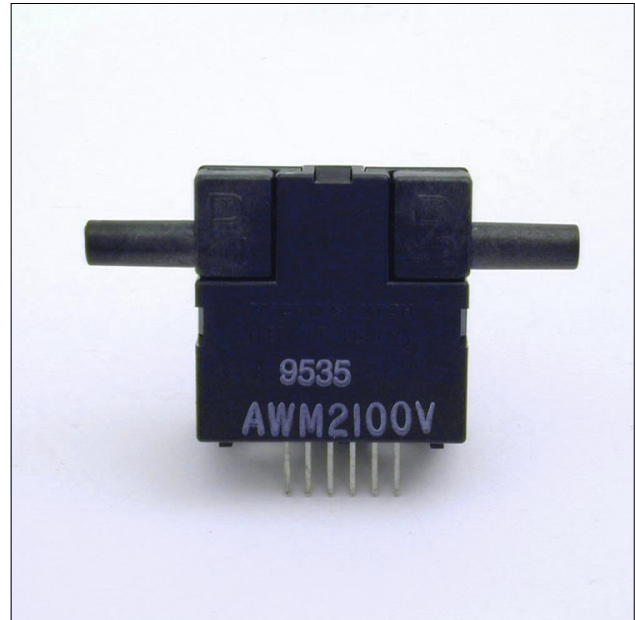

SPECIFICATIONS

Maximum ratings

Supply voltage ²	8 to 15 V typ. 10 ±0.01 V
Power consumption	max. 50 mW typ. 30 mW
Temperature limits	
Operating	-25 to 85°C
Storage	-40 to 90°C
Mechanical shock	100 g (5 drops, 6 axes)

Note:

¹ sccm denotes standard cubic centimeters per minute

² Output voltage is ratiometric to supply voltage

ELECTRICAL CONNECTION

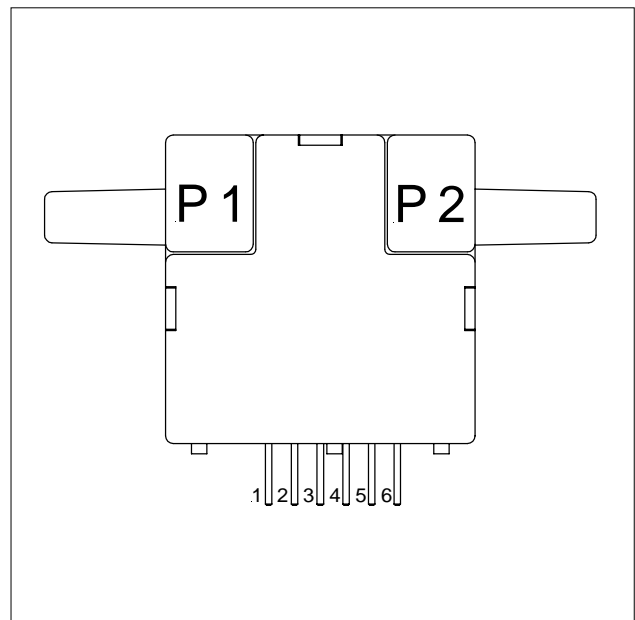

FLOW SENSOR CHARACTERISTICS³

$V_s = 10 \pm 0.01 \text{ V}$, $T_A = 25^\circ\text{C}$

Part no.	Flow range (full scale)	Pressure range	Max. flow change ⁴	Output voltage @ trim point
AWM2100V	±200 sccm		5.0 l/sec	30 mV @ 100 sccm
AWM2150V	±30 sccm		5.0 l/sec	11.8 mV @ 25 sccm
AWM2200V		±4 "H ₂ O	5.0 l/sec	20 mV @ 2 "H ₂ O
AWM2300V	±1000 sccm		5.0 l/sec	50 mV @ 650 sccm

PERFORMANCE CHARACTERISTICS

$V_s = 10 \pm 0.01 \text{ V}$, $T_A = 25^\circ\text{C}$

Characteristics		Min.	Typ.	Max.	Unit	
Zero offset		-1.0	0	1.0	mV	
Repeatability and hysteresis (combined)				±1.0 ±0.35	% reading	
Temperature effects ⁵	Offset	-25 to 85 °C ⁶			mV	
	Span	-25 to 25 °C	AWM2100V		2.5	% reading
			AWM2150V		5.0	
			AWM2200V		22.0 ⁵	
			AWM2300V		5.0	
		25 to 85 °C	AWM2100V		-2.5	
			AWM2150V		-5.0	
			AWM2200V		-22.0 ⁵	
AWM2300V				-5.0		
Sensor resistance (Pin 2 - Pin 1, Pin 6 - Pin 1)			5		kOhm	
Sensor current (Pin 2 - Pin 1, Pin 6 - Pin 1)				0.6	mA	
Response time			1.0	3.0	ms	
Common mode pressure				25	psi	

Notes:

³ A 5 micron filter is recommended for all devices.

⁴ Maximum allowable rate of flow change to prevent damage.

⁵ Temperature shifts in differential pressure devices are mostly due to the density change of the gas over temperature.

⁶ Shift is relative to 25 °C.

OUTPUT FLOW VS INTERCHANGEABILITY

$V_s = 10 \pm 0.01 \text{ V}$, $T_A = 25^\circ\text{C}$

AWM2100V				AWM2150V				AWM2200V ⁸				AWM2300V			
Press. mBar	Flow sccm	Nom. mV	Tol. \pm mV	Press. μ Bar	Flow sccm	Nom. mV	Tol. \pm mV	Flow sccm	Press. " H ₂ O	Nom. mV	Tol. \pm mV	Press. mBar	Flow sccm	Nom. mV	Tol. \pm mV
0.49	200	44.50	4.25	53	30	14.0	2.5	120	4.00	31.75	3.50	3.4	1000	55.50	3.70
0.35	150	38.75	3.00	36	20	9.5	1.5	90	3.00	26.75	2.50	2.4	800	52.90	3.50
0.21	100	30.00	1.50	17	10	5.0	1.5	60	2.00	20.00	1.20	1.8	650	50.00	2.50
0.09	50	16.50	2.50	9.8	5	2.5	1.0	30	1.00	11.20	1.80	0.83	400	42.50	3.00
0.00	0	0.00	1.00	7.4	4	2.0	1.0	0	0.00	0.00	1.00	0.31	200	29.20	3.20
-0.09	-50	-16.50	4.50	6.2	3	1.5	1.0	-30	-1.00	-11.20	3.00	0	0	0.00	1.00
-0.21	-100	-30.00	5.00	5	2	1.0	1.0	-60	-2.00	-20.00	3.30	-0.31	-200	-28.90	15.00
-0.35	-150	-38.80	7.65	2.5	1	0.5	0.8	-90	-3.00	-26.75	5.30	-0.83	-400	-41.20	26.00
-0.49	-200	-44.50	9.75	0	0	0.0	0.6	-120	-4.00	-31.75	7.00	-1.6	-600	-48.20	29.50
				-9.8	-5	-2.5	2.0					-2.4	-800	-52.20	32.50
				-53	-30	-14.0	5.0					-3.4	-1000	-55.00	36.00

Notes:

- ⁷ Numbers in **BOLD** type indicate calibration type, mass flow or differential pressure. Tolerance values apply to calibration type only.
- ⁸ Differential pressure calibrated devices are not recommended for flow measurement. Use flow calibrated devices for flow measurement.

OUTPUT CURVES

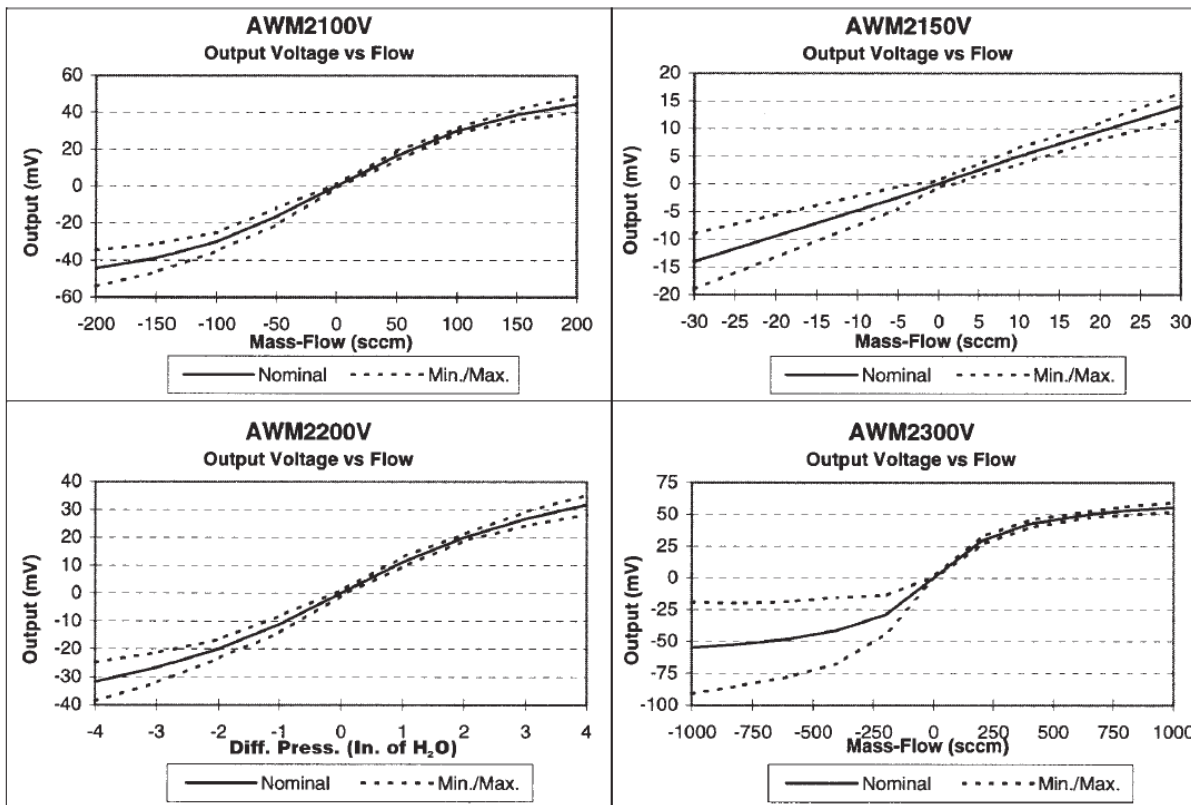

HEATER CONTROL CIRCUIT

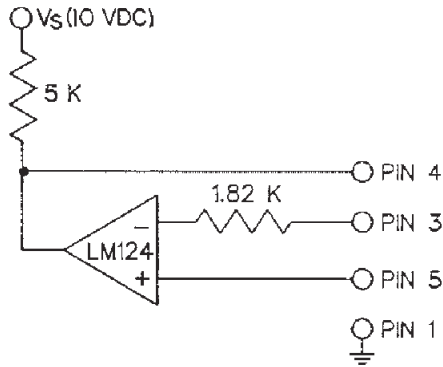

SENSING BRIDGE SUPPLY CIRCUIT

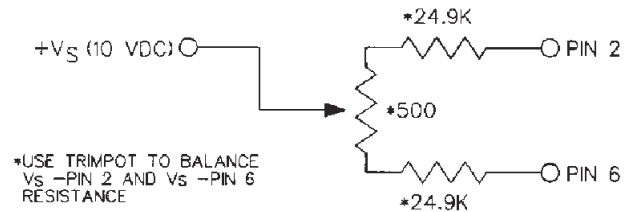

Note:
Circuits required for operation per specifications. Circuits are not on board the sensor.

DIFFERENTIAL INSTRUMENTATION AMPLIFIER CIRCUIT (OPTIONAL)

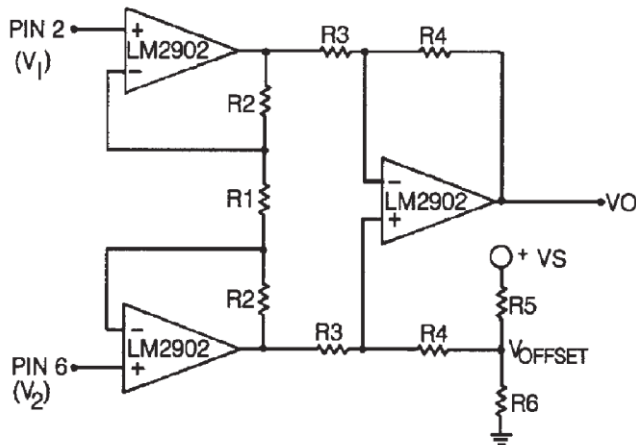

$$V_o = \left(\frac{2R_2 + R_1}{R_1} \right) \left(\frac{R_4}{R_3} \right) (V_2 - V_1) + V_{Offset}$$

where $V_{Offset} = V_s \left(\frac{R_6}{R_6 + R_5} \right)$

OUTLINE DRAWING

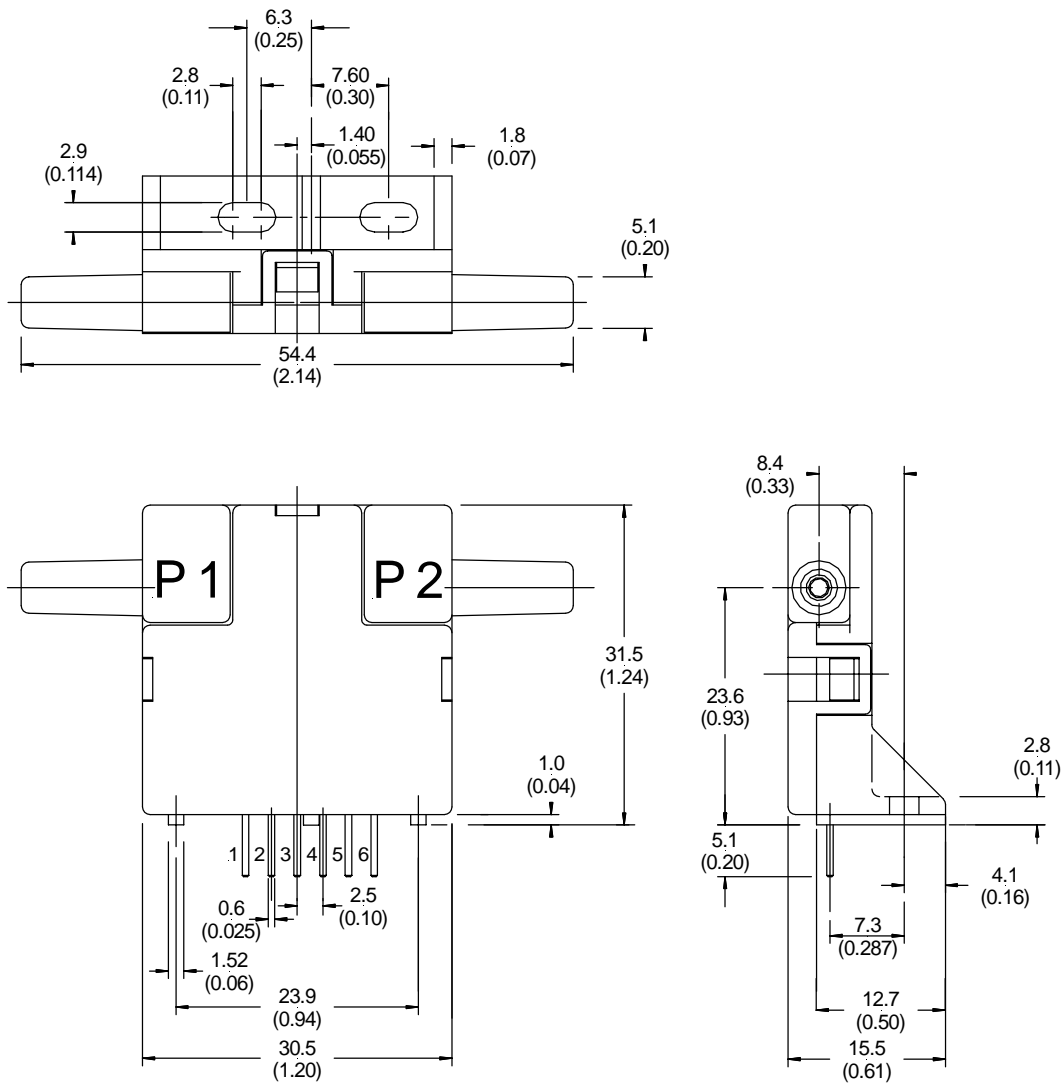

mass: approx. 10.8 g

dimensions in mm (inches)

Note:

Positive flow direction is defined as proceeding from port 1 (P1) to port 2 (P2) and results in positive output (Pin 6 > Pin 2). Negative flow direction is defined conversely and results in negative output (Pin 6 < Pin 2).

GAS CORRECTION FACTORS⁹

Gas type	Correction factor (approx.)
Helium (He)	0.5 ¹⁰
Hydrogen (H ₂)	0.7 ^{10,11}
Argon (Ar)	0.95
Nitrogen (N ₂)	1.0
Oxygen (O ₂)	1.0
Air	1.0
Nitric oxide (NO)	1.0
Carbon monoxide (CO)	1.0
Methane (CH ₄)	1.1
Ammonia (NH ₃)	1.1
Nitrous oxide (N ₂ O)	1.35
Nitrogen dioxide (NO ₂)	1.35
Carbon dioxide (CO ₂)	1.35

Notes:

⁹ Gas correction factors are referenced to nitrogen (N₂) as calibration gas type. Approximate gas correction factors are provided as guidelines only. Individual gas types may perform differently at temperature extremes and varying flow rates.

¹⁰ When sensing Hydrogen (H₂) or Helium (He) it may be necessary to power the mass flow sensor using increased supply voltage: Hydrogen typ. 12 V, Helium typ. 15 V

¹¹ Hydrogen (H₂) flow measurement requires the use of a special sensor. These devices provide normal operation when sensing hydrogen flow and are designated with an "H" at the end of the order number.

ORDERING INFORMATION

Flow range	Dry gas	Hydrogen gas ¹¹
±30 sccm	AWM2150V	---
±200 sccm	AWM2100V	AWM2100VH
±1000 sccm	AWM2300V	AWM2300VH

Pressure range	Dry gas
±4 "H ₂ O (±10 mbar)	AWM2200V

Sensortech reserves the right to make changes to any products herein. Sensortech does not assume any liability arising out of the application or use of any product or circuit described herein, neither does it convey any license under its patent rights nor the rights of others.