

# Distinctive Characteristics

Subminiature size (1/3 size of Series M switches) saves space on PC boards.

Specifically developed for logic-level applications.

Available in momentary and maintained circuits.

Industry's smallest alternate action (maintained) pushbutton with latchdown feature providing visible, audible, and tactile feedback.

Antistatic superstructure, consisting of the carbon impregnated bushing and the support bracket, prevents static discharge to the contacts. Static electricity from an operator's touch travels from the actuator through the bushing and bracket to the PC board.

Award-winning STC contact mechanism with benefits unavailable in conventional mechanisms: smoother, positive detent actuation, increased contact stability and unparalleled logic-level reliability. (Additional STC details in Terms & Acronyms; see Supplement section.)

Smooth, 6mm diameter bushing simplifies panel layout.

Totally sealed body construction prevents contact contamination and allows time- and money-saving soldering and cleaning.

.100" x .100" (2.54mm x 2.54mm) terminal spacing conforms to standard PC board grids.

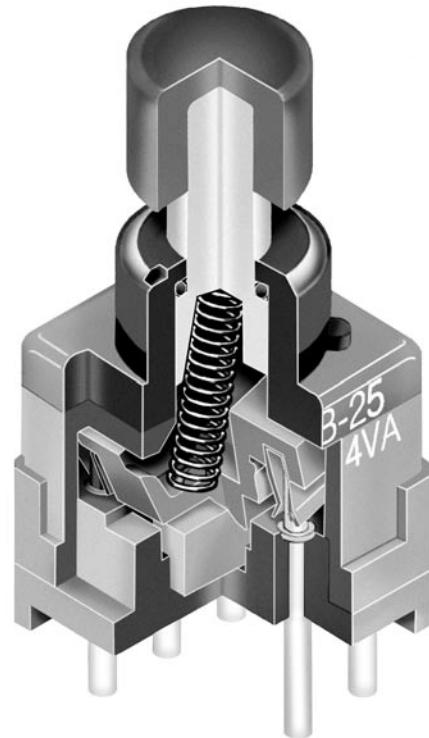

Actual Size

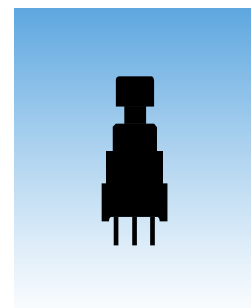

# General Specifications

## Electrical Capacity (Resistive Load)

**Logic Level:** 0.4VA maximum @ 28V AC/DC maximum  
 (Applicable Range 0.1mA ~ 0.1A @ 20mV ~ 28V)  
 Note: Find additional explanation of operating range in Supplement section.

## Other Ratings

**Contact Resistance:** 50 milliohms maximum  
**Insulation Resistance:** 500 megohms minimum @ 500V DC  
**Dielectric Strength:** 500V AC minimum for 1 minute minimum  
**Mechanical Life:** 50,000 operations minimum (momentary)  
 25,000 operations minimum (alternate action)  
**Electrical Life:** 50,000 operations minimum (momentary)  
 25,000 operations minimum (alternate action)  
**Nominal Operating Force:** 2.55N (momentary); 2.94N (alternate action)  
**Contact Timing:** Nonshorting  
**Travel:** Momentary: Pretravel .028" (0.7mm); Overtravel .016" (0.4mm); Total Travel .043" (1.1mm)  
 Alternate: Pretravel .039" (1.0mm); Overtravel .039" (1.0mm); Total Travel .079" (2.0mm)

## Materials & Finishes

**Plunger:** Polyacetal  
**Bushing:** Carbon blended polyamide  
**Case Housing:** Glass fiber reinforced polyamide  
**Support Bracket:** Tin plated phosphor bronze  
**Movable Contact:** Phosphor bronze with gold plating  
**Stationary Contacts:** Copper alloy with gold plating  
**Terminals:** Copper alloy with gold plating

## Environmental Data

**Operating Temp Range:** -30°C through +85°C (-22°F through +185°F)  
**Humidity:** 90 ~ 95% humidity for 96 hours @ 40°C (104°F)  
**Vibration:** 10 ~ 55Hz with peak-to-peak amplitude of 1.5mm traversing the frequency range & returning in 1 minute; 3 right angled directions for 2 hours  
**Shock:** 50G (490m/s<sup>2</sup>) acceleration (tested in 6 right angled directions, with 5 shocks in each direction)

## Installation

**Cap Installation Force:** 49.03N (11.2 lbf) maximum downward force on actuator;  
 actuator must be in UP position to remove cap from alternate action models

## PCB Processing

**Soldering:** Wave Soldering Recommended: See Profile A in Supplement section.  
 Manual Soldering: See Profile B in Supplement section.  
**Cleaning:** Automated cleaning. See Cleaning specifications in Supplement section.

## Standards & Certifications

**Flammability Standards:** UL94V-0 available  
**UL Recognition or CSA Certification:** The BB Series pushbuttons have not been tested for UL recognition or CSA certification. These switches are designed for use in a low-voltage, low-current, logic-level circuit. When used as intended in a logic-level circuit, the results do not produce hazardous energy.

### TYPICAL SWITCH ORDERING EXAMPLE

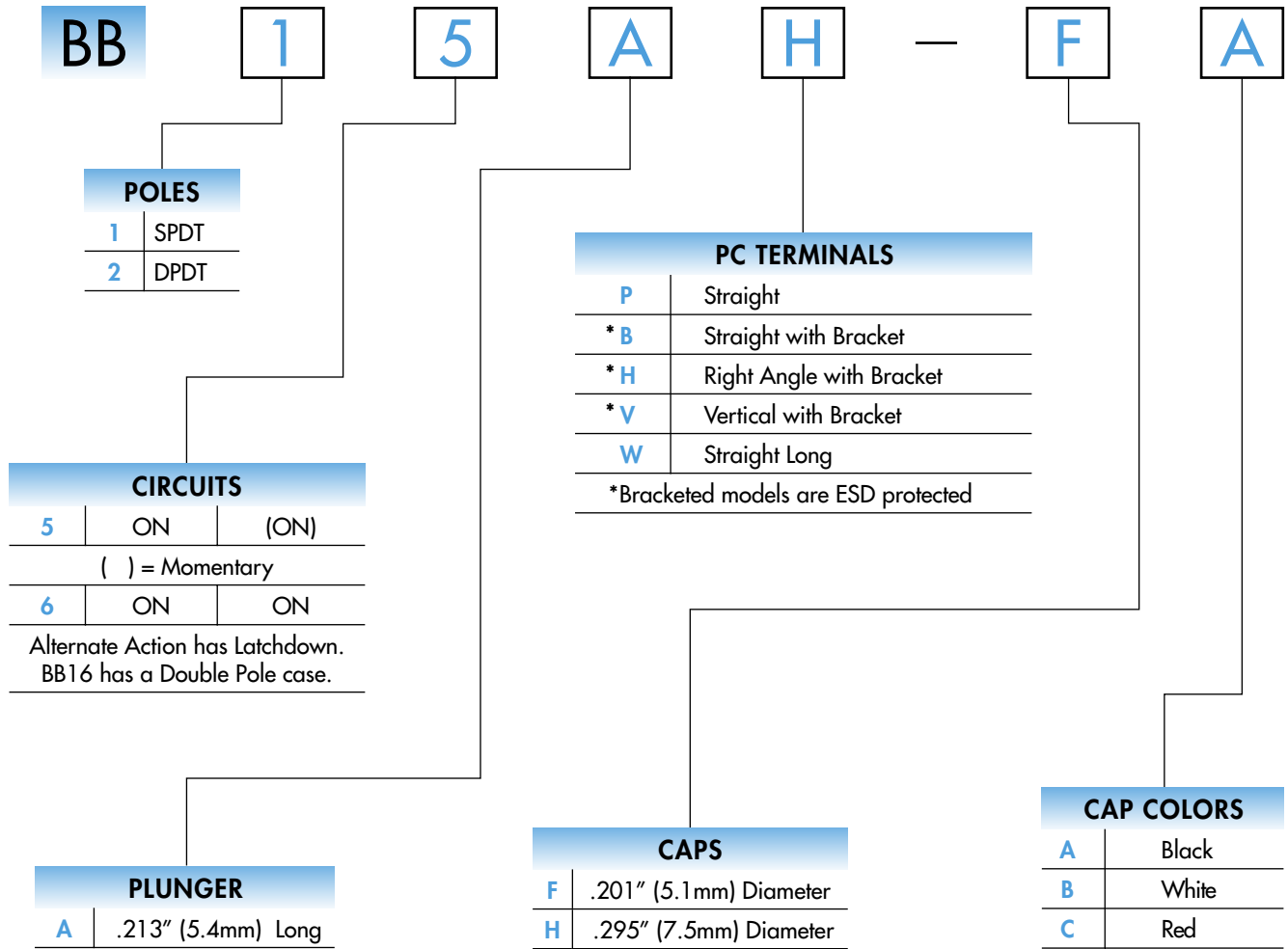



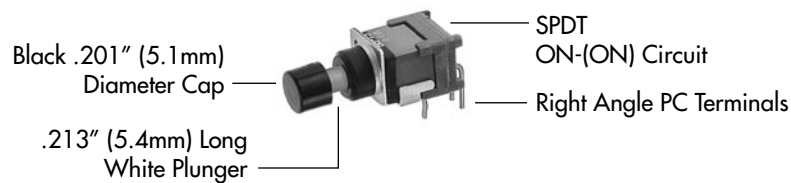

### DESCRIPTION FOR TYPICAL ORDERING EXAMPLE

#### BB15AH-FA

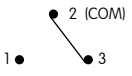
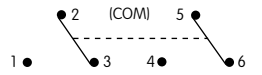

### POLES & CIRCUITS

Pole	Model	Plunger Position ( ) = Momentary		Connected Terminals		Throw & Schematics
		Normal 	Down 	Normal 	Down 	
SP	BB15 BB16	ON ON	(ON) ON	2-3	2-1	SPDT 
DP	BB25 BB26	ON ON	(ON) ON	2-3 5-6	2-1 5-4	DPDT 

Note: Terminal numbers are not actually on the switch.

### PLUNGERS

**A** .213" (5.4mm) Long

Standard Plunger Color: White

Contact factory for other colors and lengths.

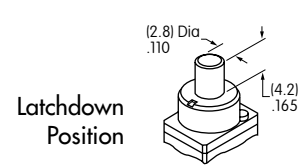
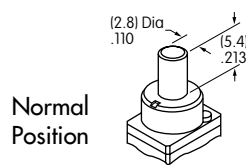

### PC TERMINALS

Use of a support bracket is recommended to increase PCB mounting strength and stability.

Both single pole and double pole alternate action models have double pole bases.

See Typical Switch Dimensions for details.

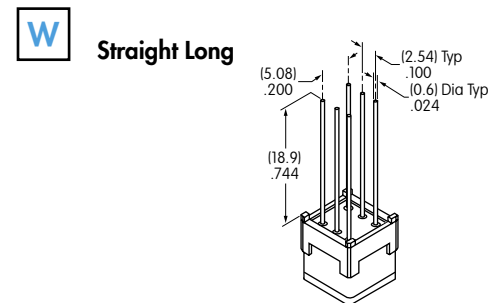
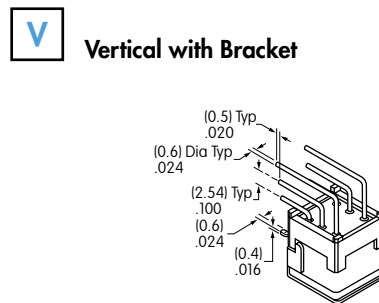
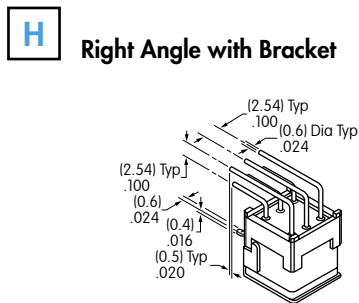
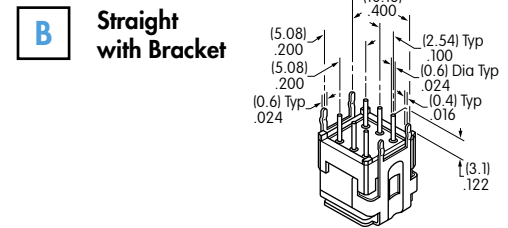
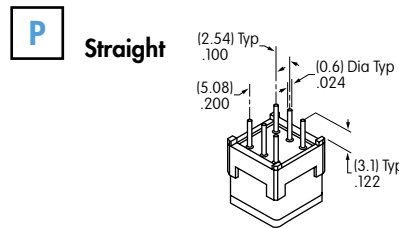

### SLIP-ON CAPS

**F** AT475  
.201" (5.1mm) Diameter Cap

Material: Polyamide

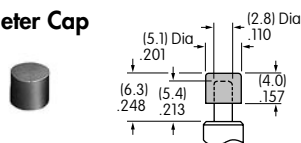

**H** AT496  
.295" (7.5mm) Diameter Cap

Material: Polyamide

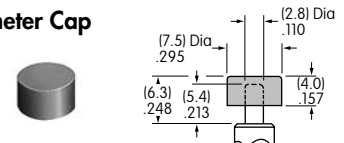

Colors Available:

**A** Black

**B** White

**C** Red

### TYPICAL SWITCH DIMENSIONS

#### Straight PC

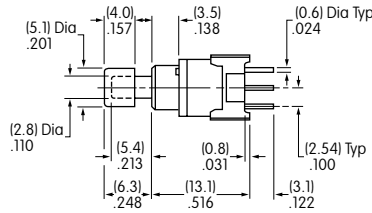
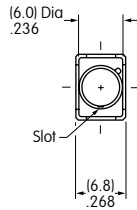

#### Single Pole

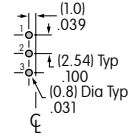
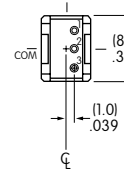

BB15AP-FA

Momentary

#### Straight PC

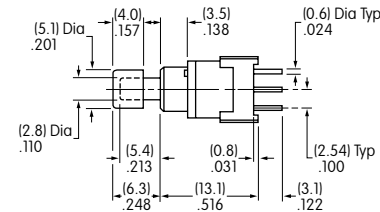
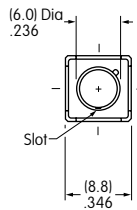

#### Double Pole

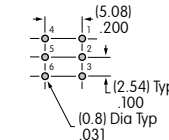
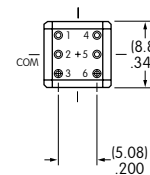

#### BB16AP

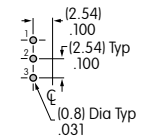
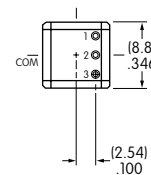

BB25AP-FA

Momentary & Alternate

Alternate

#### Straight PC • Bracket

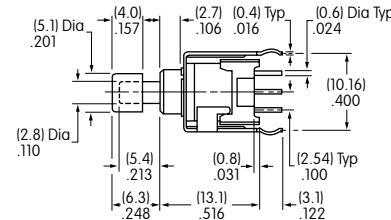
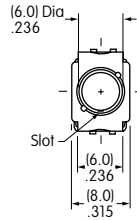

#### Single Pole

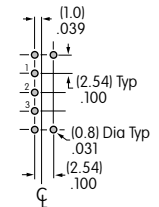
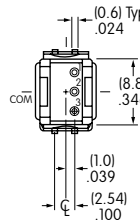

BB15AB-FA

Momentary

#### Straight PC • Bracket

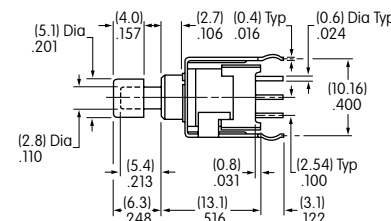
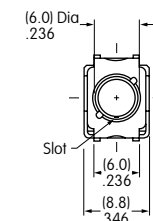

#### Double Pole

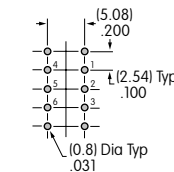
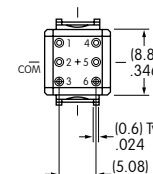

#### BB16AB

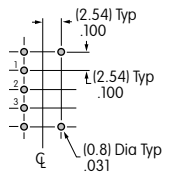
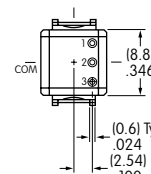

BB25AB-FA

Momentary & Alternate

Alternate

### TYPICAL SWITCH DIMENSIONS

#### Right Angle PC



BB15AH-FA

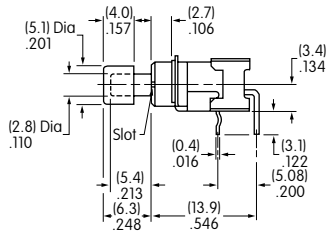
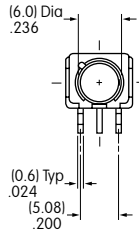

#### Single Pole

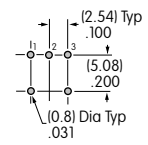
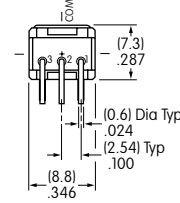

Momentary

#### Right Angle PC



BB25AH-FA

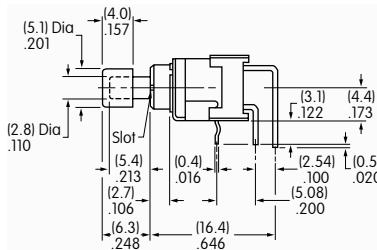
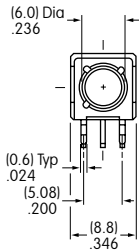

#### Double Pole

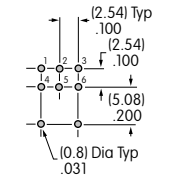
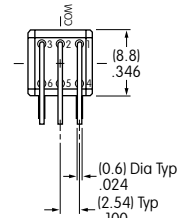

Momentary & Alternate

#### BB16AH

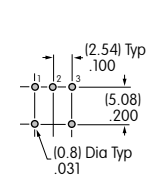
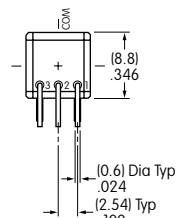

Alternate

#### Vertical PC



BB15AV-FA

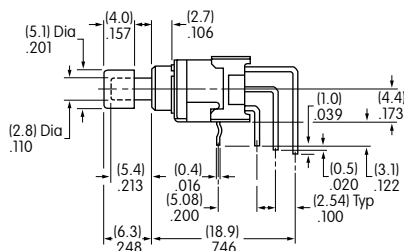
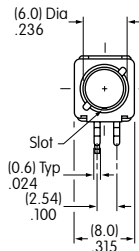

#### Single Pole

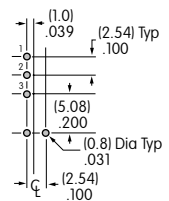
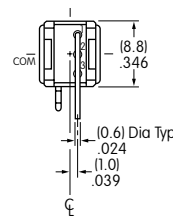

Momentary

#### Vertical PC



BB25AV-FA

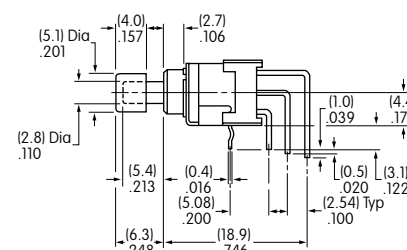
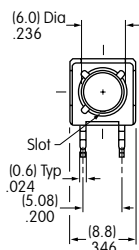

#### Double Pole

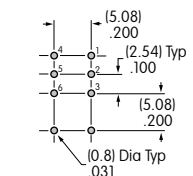
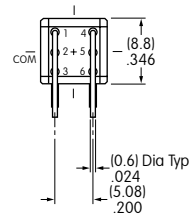

Momentary & Alternate

#### BB16AV

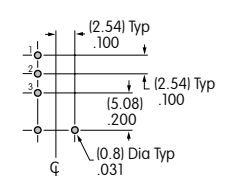
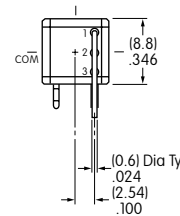

Alternate