



# PRODUCT SPECIFICATION

**Model No : CSLR-N319TG4-A0**

Descriptions:	
■ LED Type	: Lighting LED Lamp
■ LED Package	: Round LED Lamp
■ Emitting Color	: Green
■ Viewing Angle	: 50°
■ No Stopper	



CUSTOMER APPROVED SIGNATURES	APPROVED BY	CHECKED BY	PREPARED BY

**CHINA SEMICONDUCTOR CORPORATION**  
Address: 2FL. NO.909, Chung-Cheng Road,  
Chung-Ho City Taipei Hsien, Taiwan.

**OPTO PLUS TECHNOLOGIES CO.,LTD**  
Address: 696 Shun jiang Rd., Ji Shan St. Shaoxing,  
ZheJiang, China

Tel: 886-2-2223-9696  
Fax: 886-2-2223-9377

Tel: 86-0575-88623888  
Fax: 86-0575-88623112



**Model No : CSLR-N319TG4-A0**

**Features -**

1. Low Power Consumption.
2. High Luminous Output
3. High Reliability and Solid Performance
4. Optimal Optical/Mechanical Design
5. Rohs Compliant

**Device Selection Guide -**

Part No.	Chip		LED Lens
	Material	Emitted Color	
CSLR-N319TG4-A0	InGaN	Green	Water Transparent

**Package Outline Dimensions -**

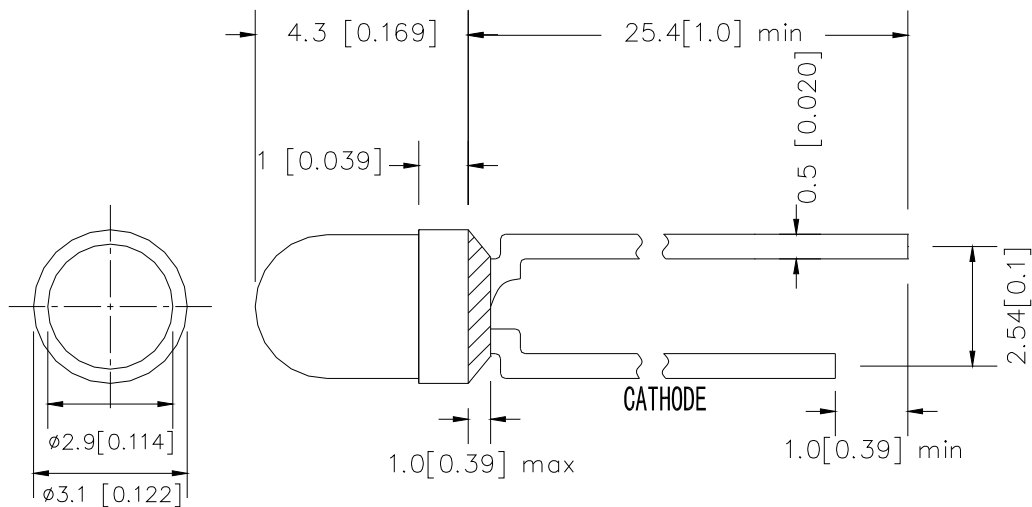

\* Tolerance :  $\pm \frac{0.01}{0.25}$  Unit :  $\pm \frac{\text{inch}}{\text{mm}}$



Model No : CSLR-N319TG4-A0

■ Absolute Maximum Rating -

(Ta=25°C)

Parameter	Symbol	Rating	Unit
Power Dissipation	Pd	76	mW
Forward Current (DC)	IF	30	mA
Peak Forward Current *	IFP	100	mA
Reverse Voltage	VR	5	V
Operating Temp.	Topr	-30 ~ +80	°C
Storage Temp.	Tstg	-40 ~ +100	°C
Lead Soldering Temperature	Tsol	Max. 260°C for 5 sec Max. (3mm from the epoxy body)	

\* Pulse width  $\leq 0.1$  msec. duty  $\leq 1/10$

■ Electro-optical Characteristics

(Ta=25°C)

Parameter	Symbol	Min.	Typ.	Max.	Unit	Condition
Forward Voltage	VF	-----	3.3	3.8	V	IF=20mA
Luminous Intensity	Iv	6600	14000	-----	mcd	
Dominant Wavelength	$\lambda D$	-----	525	-----	nm	
Viewing Angle	2 $\theta$ 1/2	-----	50	-----	deg	
Reverse Current	IR	-----	-----	50	$\mu A$	VR=5V



**Model No : CSLR-N319TG4-A0**

**■ Luminous Intensity Rank Limits (  $I_f = 20\text{mA}$  )**

unit : mcd

Part No. Code	CSLR-N319TG4-A0	
	min.	max.
V	6600	8600
W	8600	11200
X	11200	14600
Y	14600	19000
Z	19000	24700

**■ Dominant Wavelength Rank Limits (  $I_f = 20\text{mA}$  )**

unit : nm

Part No. Code	CSLR-N319TG4-A0	
	min.	max.
TG2	520	525
TG3	525	530
TG4	530	535

**■ Forward Voltage Rank Limits (  $I_f = 20\text{mA}$  )**

unit : v

Part No. Code	CSLR-N319TG4-A0	
	min.	max.
H	2.8	3.0
J	3.0	3.2
K	3.2	3.4
L	3.4	3.6
M	3.6	3.8

Notes:

1. Tolerance of measurement of luminous intensity :±15%
2. Tolerance of measurement of Color Coordinates :±0.01
3. Tolerance of measurement of forward voltage :±0.05v
4. All data are measured by CSC's test equipment.
5. One delivery will include several color rank, VF rank and Iv ranks of the products.
6. The quantity-ratio of the ranks is decided by CSC.
7. Please confirm with CSC salesman, if your request different from standard specification.



Model No : CSLR-N319TG4-A0

■ Typical Electrical / Optical Characteristics Curves -

(Ta = 25°C Unless Otherwise Noted)

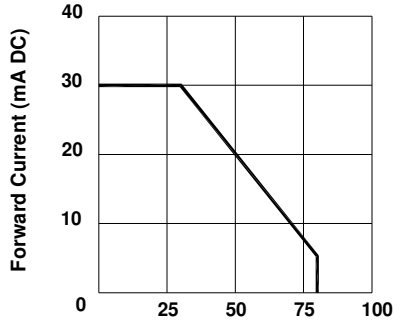

Ambient Temperature Ta (°C)  
Fig 1. Forward Current  
Vs. Ambient Temperature

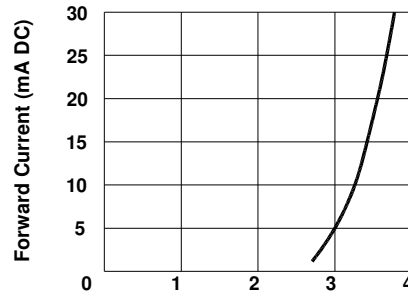

Forward Voltage VF (V)  
Fig 2. Forward Current  
Vs. Forward Voltage

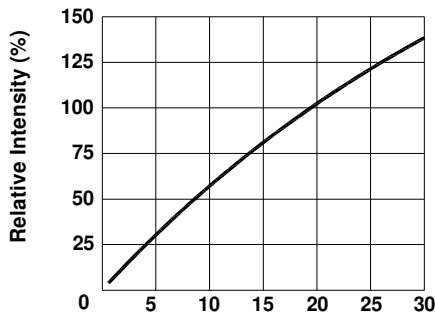

Forward Current IF (mA DC)  
Fig 3. Relative Intensity  
Vs. Forward Current

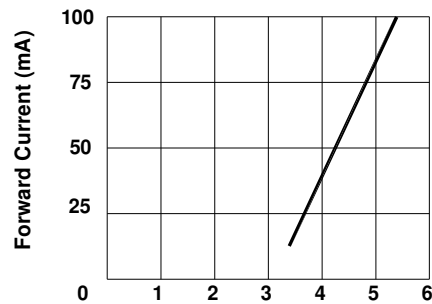

Forward Voltage (V)  
Fig 4. Peak Forward Voltage  
Vs. Forward Current  
(100us test pulse, 1% duty cycle)

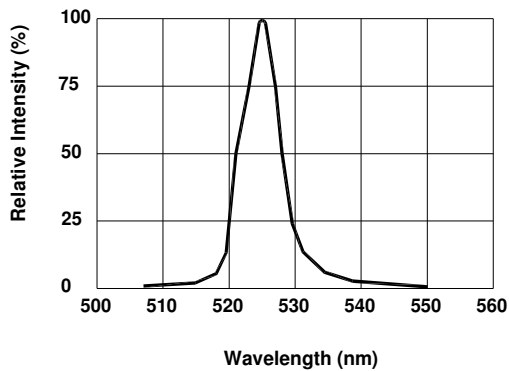

Fig 5. Relative Intensity Vs. Wavelength

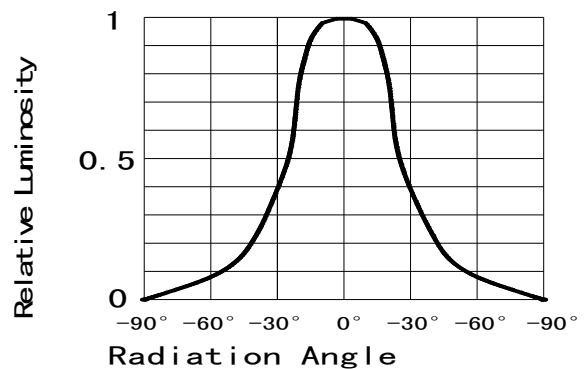

Fig 6. Relative Luminous Intensity vs. Radiation Angle



Model No : CSLR-N319TG4-A0

## ■ Precautions For Use -

### 1. Recommended Soldering conditions

#### Wave Soldering

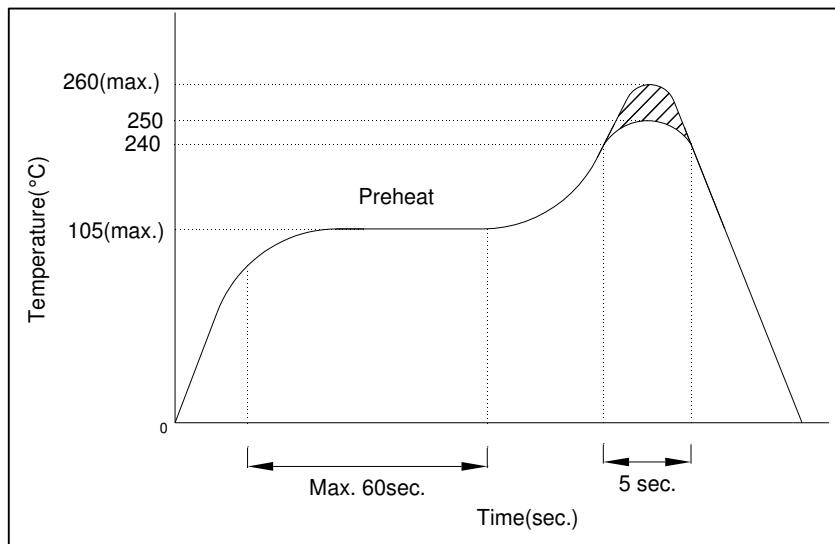

### 2. Soldering Iron

Basic SPEC. is  $\leq 5$ sec. When  $260^{\circ}\text{C}$ . If temperature is higher, time should be shorter ( $+10^{\circ}\text{C} \rightarrow -1$ sec.). Power dissipation of iron should be smaller than 15W, and temperature should be controllable. Surface temperature of the device should be under  $230^{\circ}\text{C}$ .

### 3. Static Electricity

- Static electricity or surge voltage damages LEDs..  
It is recommended that a wrist band or an anti-electrostatic glove be used when handling the LEDs.
- All devices, equipment and machinery must be properly grounded. It is recommended that measures be taken against surge voltage to the equipment that mounts the LEDs.

Note: The specifications are subject to change without notice. Please contact us for updated information.