

RoHS Compliant Product

Description

The SSL4407 provide the designer with the best combination of fast switching, ruggedized device design, low on-resistance and cost-effectiveness.

The TO-263 is universally preferred for all commercial-industrial surface mount applications and suited for low voltage applications such as DC/DC converters and high efficiency switching circuit.

Features

- * Lower On-Resistance
- * Simple Drive Requirement
- * Fast Switching Characteristics

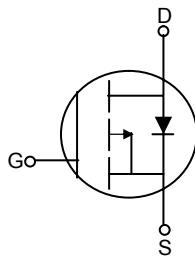
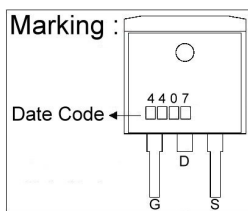
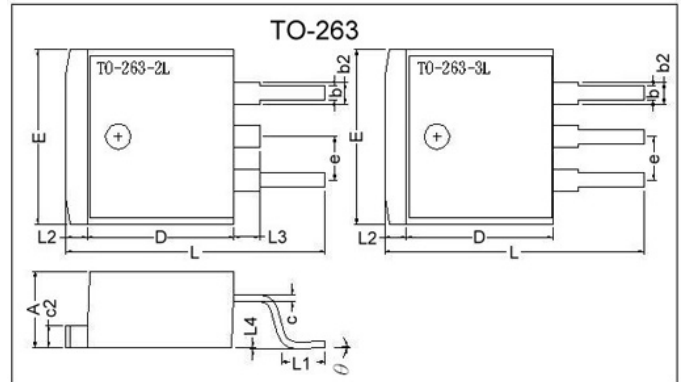

REF.	Millimeter		REF.	Millimeter	
	Min.	Max.		Min.	Max.
A	4.40	4.80	c2	1.25	1.45
b	0.76	1.00	b2	1.17	1.47
L4	0.00	0.30	D	8.6	9.0
c	0.36	0.5	e	2.54 REF.	
L3	1.50 REF.		L	14.6	15.8
L1	2.29	2.79	θ	0°	8°
E	9.80	10.4	L2	1.27 REF.	

Absolute Maximum Ratings

Parameter	Symbol	Ratings	Unit
Drain-Source Voltage	V _{DS}	-30	V
Gate-Source Voltage	V _{GS}	±25	V
Continuous Drain Current, V _{GS} @10V	I _D @T _A =25°C	-50	A
Continuous Drain Current, V _{GS} @10V	I _D @T _A =100°C	-32	A
Pulsed Drain Current ¹	I _{DM}	-180	A
Total Power Dissipation	P _D @T _A =25°C	54	W
Linear Derating Factor		0.4	W/°C
Operating Junction and Storage Temperature Range	T _j , T _{stg}	-55~+150	°C

Thermal Data

Parameter	Symbol	Ratings	Unit
Thermal Resistance Junction-case	R _{thj-c}	2.3	°C/W
Thermal Resistance Junction-ambient	R _{thj-a}	62	°C/W

Electrical Characteristics (T_j=25°C Unless otherwise specified)

Parameter	Symbol	Min.	Typ.	Max.	Unit	Test Condition
Drain-Source Breakdown Voltage	BV _{DSS}	-30	-	-	V	V _{GS} =0V, I _D =-250uA
Breakdown Voltage Temp. Coefficient	ΔBV _{Ds} /ΔT _j	-	-0.01	-	V/°C	Reference to 25°C, I _D =-1mA
Gate Threshold Voltage	V _{GS(th)}	-1.0	-	-3.0	V	V _{DS} =V _{GS} , I _D =-250uA
Gate-Source Leakage Current	I _{GSS}	-	-	±100	nA	V _{GS} =±25V
Drain-Source Leakage Current (T _j =25°C)	I _{DSS}	-	-	-1	uA	V _{DS} =-30V, V _{GS} =0
Drain-Source Leakage Current(T _j =150°C)		-	-	-25	uA	V _{DS} =-24V, V _{GS} =0
Static Drain-Source On-Resistance ²	R _{DS(ON)}	-	-	14	mΩ	V _{GS} =-10V, I _D =-24A
		-	-	23		V _{GS} =-4.5V, I _D =-16A
Total Gate Charge ²	Q _g	-	35	60	nC	I _D =-24A V _{DS} =-24V V _{GS} =4.5V
Gate-Source Charge	Q _{gs}	-	5	-		
Gate-Drain ("Miller") Charge	Q _{gd}	-	26	-		
Turn-on Delay Time ²	T _{d(ON)}	-	11	-	nS	V _{DD} =-15V I _D =-24A V _{GS} =-10V R _G =3.3Ω R _D =0.63Ω
Rise Time	T _r	-	64	-		
Turn-off Delay Time	T _{d(OFF)}	-	63	-		
Fall Time	T _f	-	100	-		
Input Capacitance	C _{iss}	-	2120	3390	pF	V _{GS} =0V V _{DS} =-25V f=1.0MHz
Output Capacitance	C _{oss}	-	630	-		
Reverse Transfer Capacitance	C _{rss}	-	550	-		
Forward Transconductance	G _{fs}	-	36	-	S	V _{DS} =-10V, I _D =-24A

Source-Drain Diode

Parameter	Symbol	Min.	Typ.	Max.	Unit	Test Condition
Forward On Voltage ²	V _{SD}	-	-	-1.2	V	I _S =-24A, V _{GS} =0V.
Reverse Recovery Time ²	T _{rr}	-	39	-	nS	I _S =-24A, V _{GS} =0V. dI/dt=100A/us
Reverse Recovery Charge	Q _{rr}	-	38	-	nC	

Notes: 1. Pulse width limited by safe operating area.

2. Pulse width ≤300us, duty cycle ≤2%.

Characteristics Curve

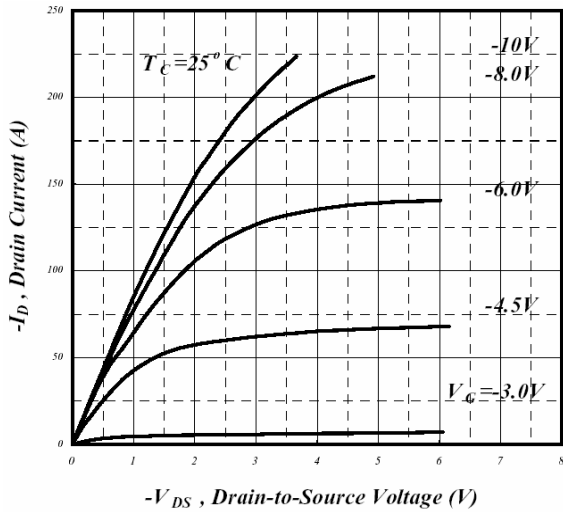

Fig 1. Typical Output Characteristics

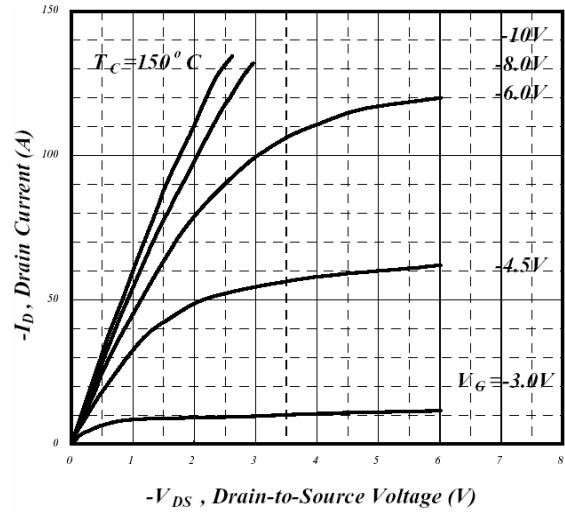

Fig 2. Typical Output Characteristics

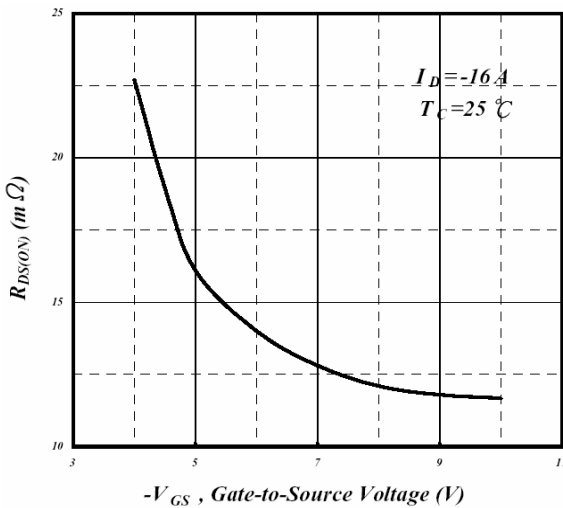

Fig 3. On-Resistance v.s. Gate Voltage

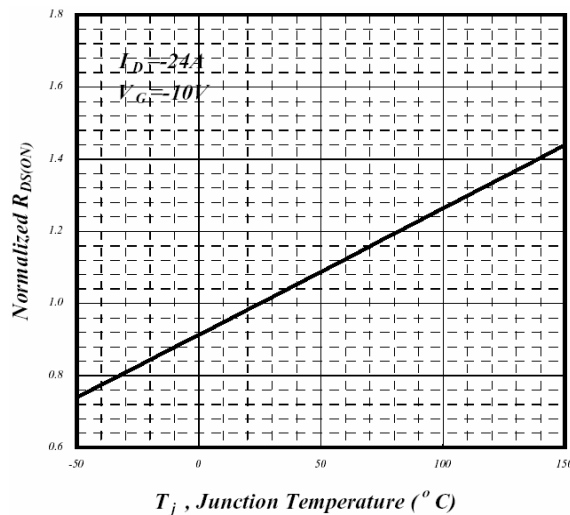

Fig 4. Normalized On-Resistance v.s. Junction Temperature

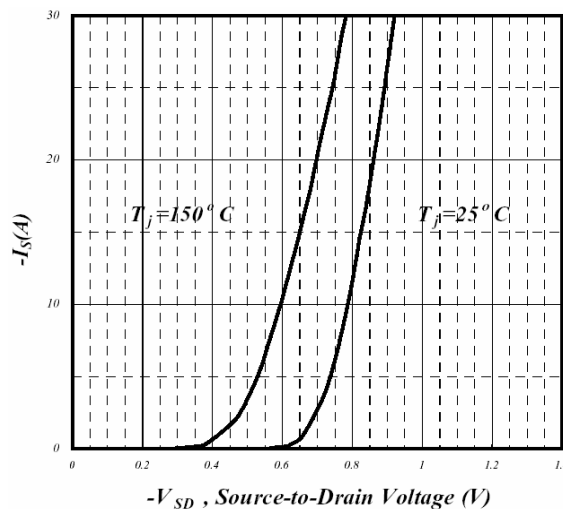

Fig 5. Forward Characteristics of Reverse Diode

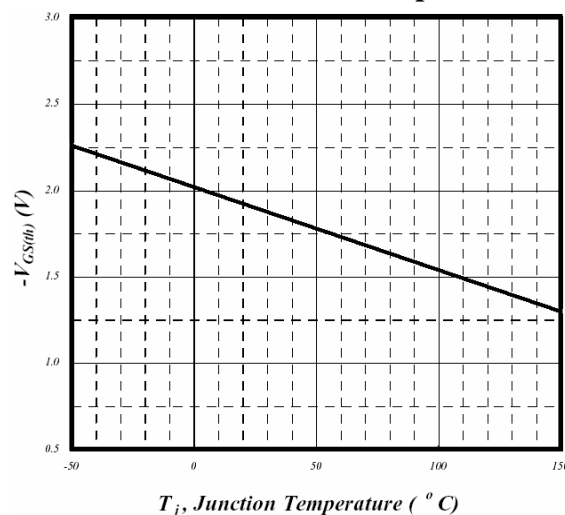

Fig 6. Gate Threshold Voltage v.s. Junction Temperature

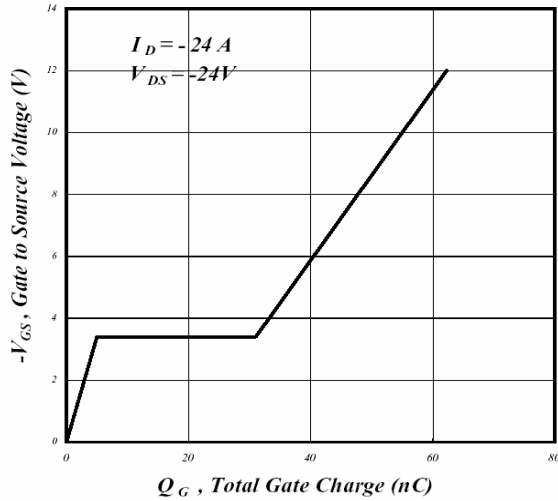

Fig 7. Gate Charge Characteristics

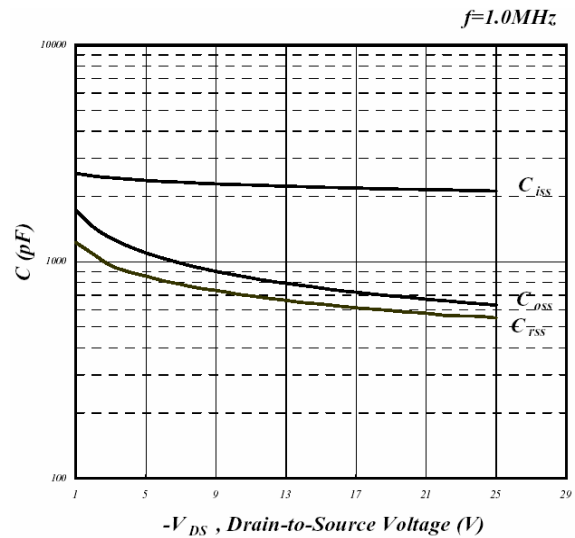

Fig 8. Typical Capacitance Characteristics

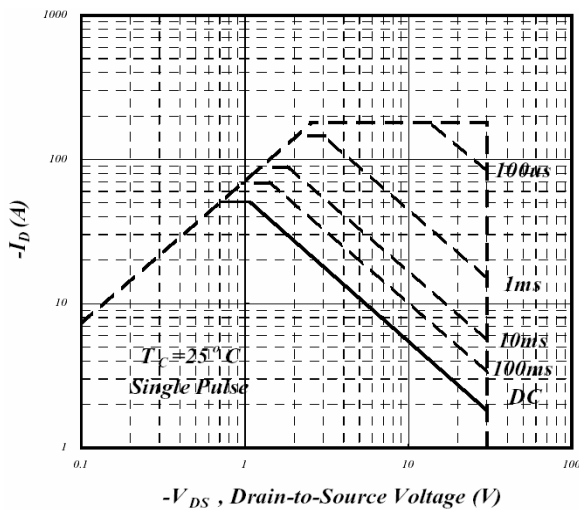

Fig 9. Maximum Safe Operating Area

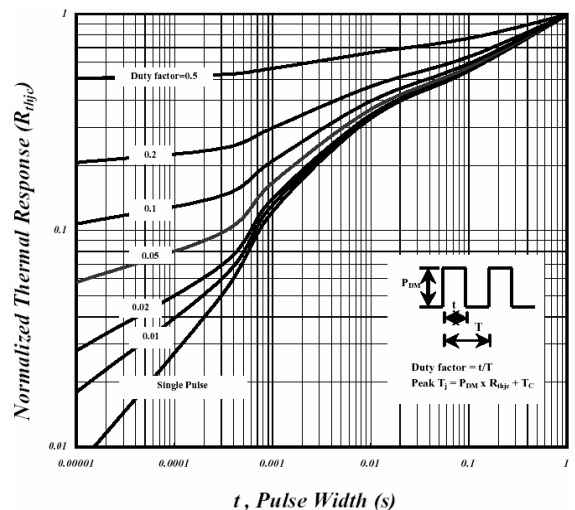

Fig 10. Effective Transient Thermal Impedance

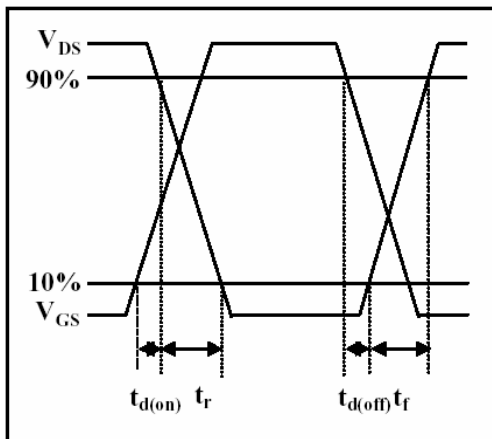

Fig 11. Switching Time Waveform

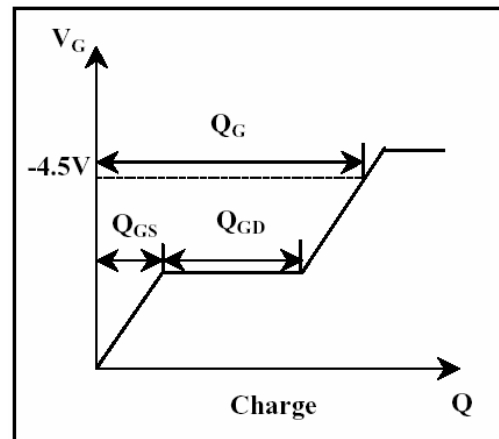

Fig 12. Gate Charge Waveform