

**LED NUMERIC DISPLAY, 1 DIGIT**
**BL-S230X-11XX**
**Features:**

- 56.80mm (2.3") single digit numeric display series, BI-COLOR TYPE
- Low current operation.
- Excellent character appearance.
- Easy mounting on P.C. Boards or sockets.
- I.C. Compatible.
- ROHS Compliance.

**Electrical-optical characteristics: (Ta=25°C) (Test Condition: IF=20mA)**

Part No		Chip			VF Unit:V		Iv TYP.(mcd)
Common Cathode	Common Anode	Emitted Color	Material	$\lambda_p$ (nm)	Typ	Max	
BL-S230E-11SG-XX	BL-S230F-11SG-XX	Super Red	AlGaInP	660	2.10	2.50	150
		Green	GaP/GaP	570	2.20	2.50	165
BL-S230E-11EG-XX	BL-S230F-11EG-XX	Orange	GaAsP/GaP	635	2.10	2.50	165
		Green	GaP/GaP	570	2.20	2.50	165
BL-S230E-11DUG-X X	BL-S230F-11DUG-X X	Ultra Red	AlGaInP	660	2.10	2.50	220
		Ultra Green	AlGaInP	574	2.20	2.50	220
BL-S230E-11UEUG- XX	BL-S230F-11UEUG- XX	Ultra Orange	AlGaInP	630	2.10	2.50	170
		Ultra Green	AlGaInP	574	2.20	2.50	220

**-XX: Surface / Lens color:**

Number	0	1	2	3	4	5
<b>Ref Surface Color</b>	White	Black	Gray	Red	Green	
<b>Epoxy Color</b>	Water clear	White diffused	Red Diffused	Green Diffused	Yellow Diffused	

**Absolute maximum ratings (Ta=25°C)**

Parameter	S	G	E	D	UG	UE		U nit
Forward Current $I_F$	30	30	30	30	30	30		mA
Power Dissipation $P_d$	75	80	80	75	75	65		mW
Reverse Voltage $V_R$	5	5	5	5	5	5		V
Peak Forward Current $I_{PF}$ (Duty 1/10 @1KHZ)	150	150	150	150	150	150		mA
Operation Temperature $T_{OPR}$	-40 to +80							°C
Storage Temperature $T_{STG}$	-40 to +85							°C
Lead Soldering Temperature $T_{SOL}$	Max.260±5°C for 3 sec Max. (1.6mm from the base of the epoxy bulb)							°C

**LED NUMERIC DISPLAY, 1 DIGIT**

**BL-S230X-11XX**

■ **Package configuration & Internal circuit diagram**

**BL-S230X-11Series**

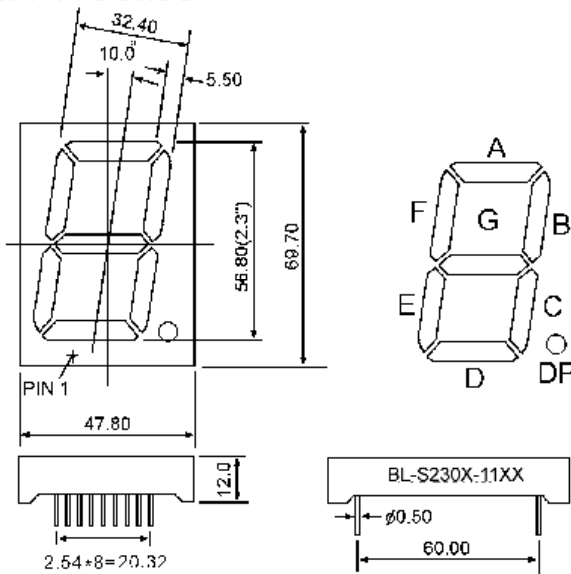

**BL-S230E-11xx**

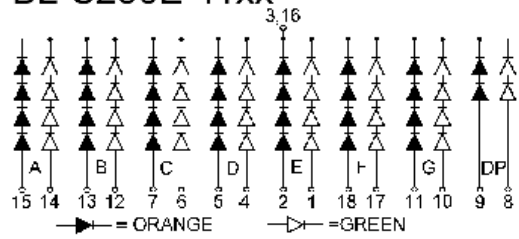

**BL-S230F-11xx**

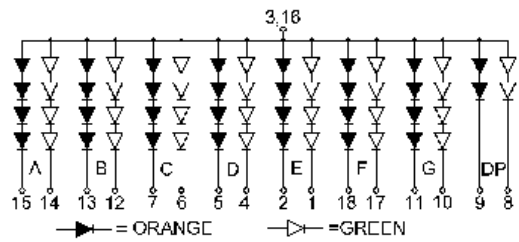

[WWW.BETLUX.COM](http://WWW.BETLUX.COM)

**Notes:**

1. All dimensions are in millimeters (inches)
2. Tolerance is  $\pm 0.25(0.01)$  unless otherwise noted.
3. Specifications are subject to change without notice.

## LED NUMERIC DISPLAY, 1 DIGIT

BL-S230X-11XX

### Typical electrical-optical characteristics curves:



- |   |                                      |
|---|--------------------------------------|
| (1) - GaAsP/GaAs 655nm/Red                | (9) - GaAlAs 880nm                   |
| (2) - GaP 570nm/Yellow Green              | (10) - GaAs/GaAs & GaAlAs/GaAs 940nm |
| (3) - GaAsP/GaP 585nm/Yellow              | (A) - GaN/SiC 430nm/Blue             |
| (4) - GaAsP/GaP 635nm/Orange & Hi-Eff Red | (B) - InGaN/SiC 470nm/Blue           |
| (5) - GaP 700nm/Bright Red                | (C) - InGaN/SiC 505nm/Ultra Green    |
| (6) - GaAlAs/GaAs 660nm/Super Red         | (D) - InGaN/SiC 525nm/Ultra Green    |
| (8) - GaAsP/GaP 610nm/Super Red           |                                      |

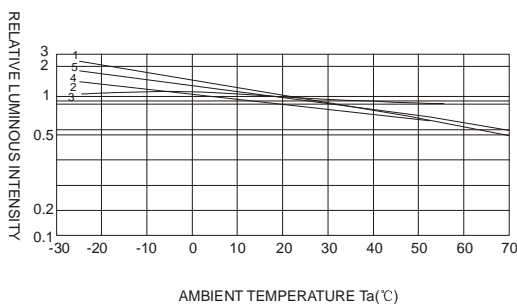
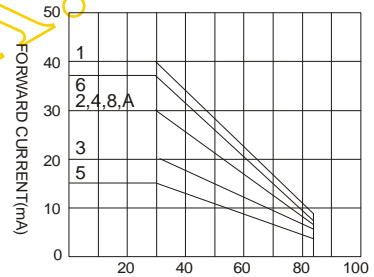
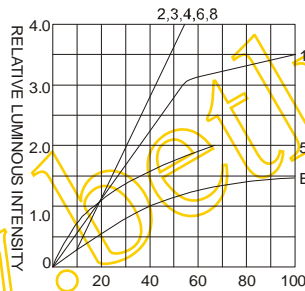
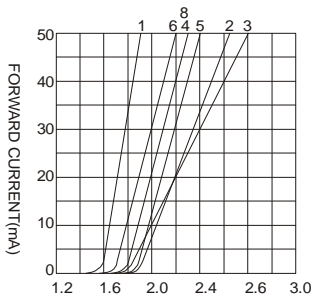

NOTE:25°C free air temperature unless otherwise specified