

MITSUBISHI IGBT MODULES
CM50RL-24NF

HIGH POWER SWITCHING USE

CM50RL-24NF



- IC 50A
- VCES 1200V
- Insulated Type
- 7-elements in a pack

APPLICATION

AC drive inverters & Servo controls, etc

OUTLINE DRAWING & CIRCUIT DIAGRAM

Dimensions in mm

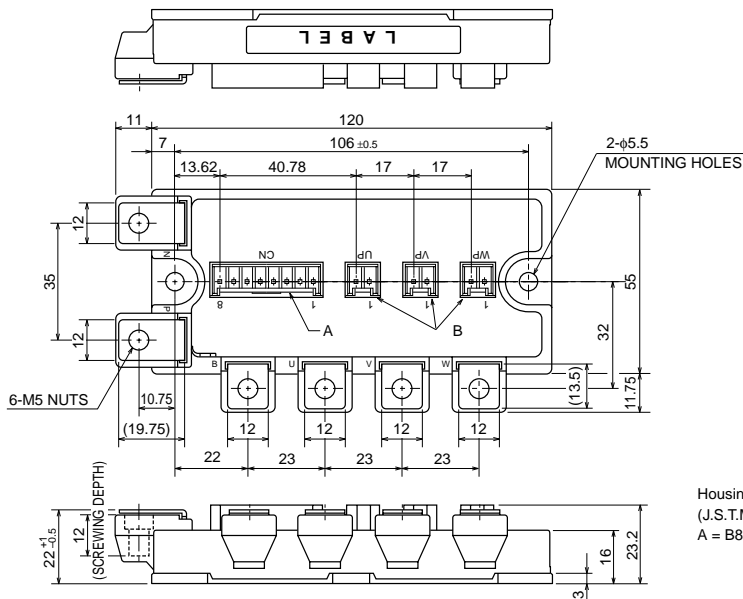

Housing Type of A and B
 (J.S.T.Mfg.Co.Ltd)
 A = B8P-VH-FB-B, B = B2P-VH-FB-B

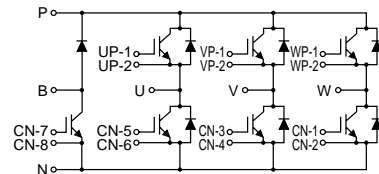

CIRCUIT DIAGRAM

CM50RL-24NF

HIGH POWER SWITCHING USE

ABSOLUTE MAXIMUM RATINGS (T_j = 25°C)
INVERTER PART

Symbol	Parameter	Conditions	Ratings	Unit
V _{CES}	Collector-emitter voltage	G-E Short	1200	V
V _{GES}	Gate-emitter voltage	C-E Short	±20	V
I _C	Collector current	DC, T _c = 94°C ^{*1}	50	A
I _{CM}		Pulse (Note 2)	100	A
I _E (Note 1)	Emitter current		50	A
I _{EM} (Note 1)		Pulse (Note 2)	100	A
P _C (Note 3)	Maximum collector dissipation	T _c = 25°C	390	W

BRAKE PART

Symbol	Parameter	Conditions	Ratings	Unit
V _{CES}	Collector-emitter voltage	G-E Short	1200	V
V _{GES}	Gate-emitter voltage	C-E Short	±20	V
I _C	Collector current	DC, T _c = 104°C ^{*1}	30	A
I _{CM}		Pulse (Note 2)	60	A
P _C (Note 3)	Maximum collector dissipation	T _c = 25°C	290	W
V _{RRM}	Repetitive peak reverse voltage	Clamp diode part	1200	V
I _{FM}	Forward current	Clamp diode part	30	A

(COMMON RATING)

Symbol	Parameter	Conditions	Ratings	Unit
T _j	Junction temperature		-40 ~ +150	°C
T _{stg}	Storage temperature		-40 ~ +125	°C
V _{iso}	Isolation voltage	Main Terminal to base plate, AC 1 min.	2500	V
—	Torque strength	Main Terminal M5	2.5 ~ 3.5	N • m
—		Mounting holes M5	2.5 ~ 3.5	N • m
—	Weight	Typical value	350	g

ELECTRICAL CHARACTERISTICS (T_j = 25°C)
INVERTER PART

Symbol	Parameter	Test conditions	Limits			Unit
			Min.	Typ.	Max.	
ICES	Collector cutoff current	VCE = VCES, VGE = 0V	—	—	1	mA
VGE(th)	Gate-emitter threshold voltage	IC = 5.0mA, VCE = 10V	6	7	8	V
IGES	Gate leakage current	VGE = VGES, VCE = 0V	—	—	0.5	μA
VCE(sat)	Collector-emitter saturation voltage	IC = 50A, VGE = 15V	—	2.1	3.0	V
		T _j = 25°C T _j = 125°C	—	2.4	—	
Cies	Input capacitance	VCE = 10V VGE = 0V	—	—	8.5	nF
Co _{es}	Output capacitance		—	—	0.75	nF
C _{res}	Reverse transfer capacitance		—	—	0.17	nF
QG	Total gate charge	VCC = 600V, IC = 50A, VGE = 15V	—	250	—	nC
td(on)	Turn-on delay time	VCC = 600V, IC = 50A VGE1 = VGE2 = 15V RG = 6.3Ω, Inductive load switching operation IE = 50A	—	—	100	ns
tr	Turn-on rise time		—	—	50	ns
td(off)	Turn-off delay time		—	—	300	ns
tf	Turn-off fall time		—	—	350	ns
t _{rr} (Note 1)	Reverse recovery time		—	—	100	ns
Q _{rr} (Note 1)	Reverse recovery charge	—	2	—	μC	
VEC(Note 1)	Emitter-collector voltage	IE = 50A, VGE = 0V	—	—	3.8	V
R _{th(j-c)Q}	Thermal resistance	IGBT part (1/6 module) ^{*1}	—	—	0.32	°C/W
R _{th(j-c)R}		FWDi part (1/6 module) ^{*1}	—	—	0.43	°C/W
R _{th(c-f)}	Contact thermal resistance	Case to fin, Thermal compound Applied (1/6 module) ^{*2}	—	0.085	—	°C/W
RG	External gate resistance		6.3	—	96	Ω

BRAKE PART

Symbol	Parameter	Test conditions	Limits			Unit
			Min.	Typ.	Max.	
ICES	Collector cutoff current	VCE = VCES, VGE = 0V	—	—	1	mA
VGE(th)	Gate-emitter threshold voltage	IC = 3.0mA	6	7	8	V
IGES	Gate leakage current	VGE = VGES, VCE = 0V	—	—	0.5	μA
VCE(sat)	Collector-emitter saturation voltage	IC = 30A, VGE = 15V	—	2.1	3.0	V
		T _j = 25°C T _j = 125°C	—	2.4	—	
Cies	Input capacitance	VCE = 10V VGE = 0V	—	—	5.1	nF
Co _{es}	Output capacitance		—	—	0.45	nF
C _{res}	Reverse transfer capacitance		—	—	0.10	nF
QG	Total gate charge	VCC = 600V, IC = 30A, VGE = 15V	—	150	—	nC
VFM	Forward voltage drop	IF = 30A	—	—	3.8	V
R _{th(j-c)Q}	Thermal resistance	IGBT part ^{*1}	—	—	0.43	°C/W
R _{th(j-c)R}		Clamp diode part ^{*1}	—	—	0.65	°C/W
RG	External gate resistance		10	—	100	Ω

*1 : T_c measured point is just under the chips.

If you use this value, R_{th(f-a)} should be measured just under the chips.

*2 : Typical value is measured by using Shin-etsu Silicone "G-746".

Note 1. IE, VEC, t_{rr} & Q_{rr} represent characteristics of the anti-parallel, emitter to collector free-wheel diode (FWDi).

2. Pulse width and repetition rate should be such that the device junction temp. (T_j) does not exceed T_{jmax} rating.

3. Junction temperature (T_j) should not increase beyond 150°C.

4. Pulse width and repetition rate should be such as to cause negligible temperature rise.

CM50RL-24NF

HIGH POWER SWITCHING USE

PERFORMANCE CURVES

OUTPUT CHARACTERISTICS (TYPICAL)

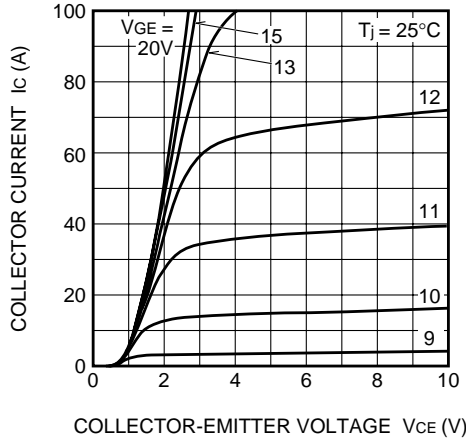

COLLECTOR-EMITTER SATURATION VOLTAGE CHARACTERISTICS (TYPICAL)

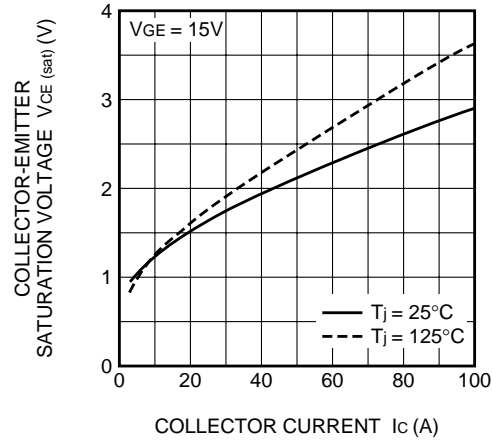

COLLECTOR-EMITTER SATURATION VOLTAGE CHARACTERISTICS (TYPICAL)

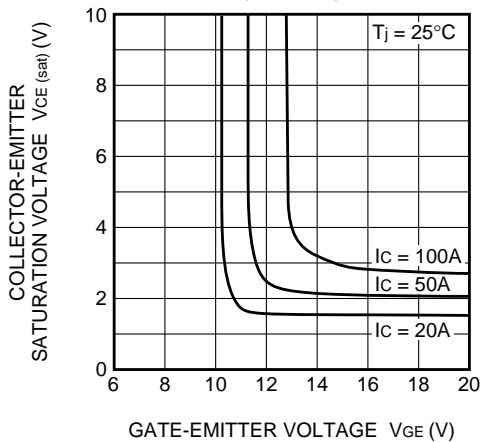

FREE-WHEEL DIODE FORWARD CHARACTERISTICS (TYPICAL)

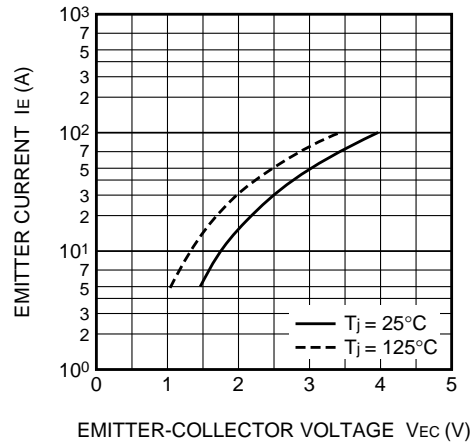

CAPACITANCE-VCE CHARACTERISTICS (TYPICAL)

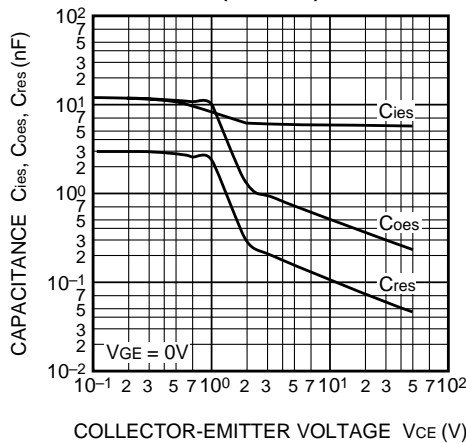

HALF-BRIDGE SWITCHING CHARACTERISTICS (TYPICAL)

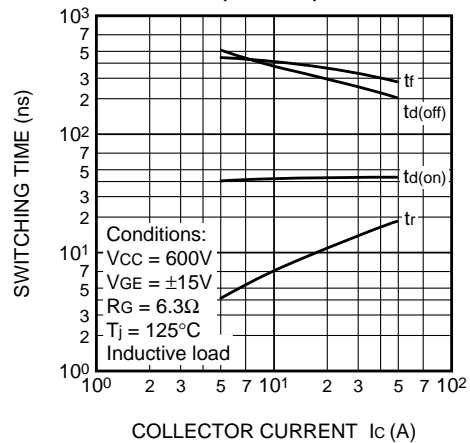

CM50RL-24NF

HIGH POWER SWITCHING USE

REVERSE RECOVERY CHARACTERISTICS OF FREE-WHEEL DIODE (TYPICAL)

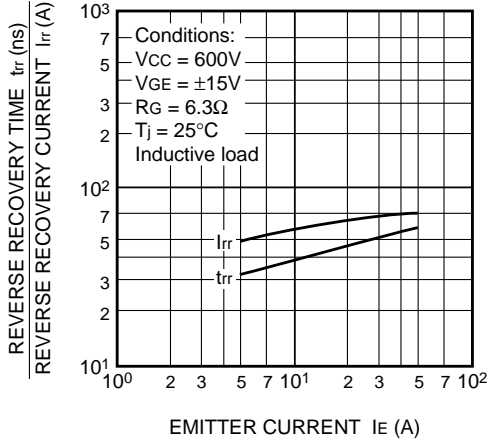

TRANSIENT THERMAL IMPEDANCE CHARACTERISTICS (IGBT part & FWDi part)

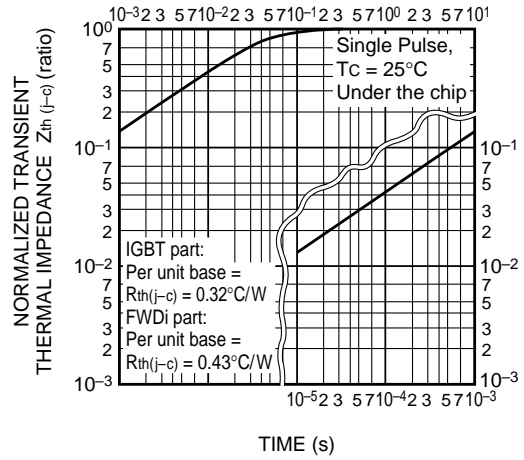

SWITCHING LOSS vs. COLLECTOR CURRENT (TYPICAL)

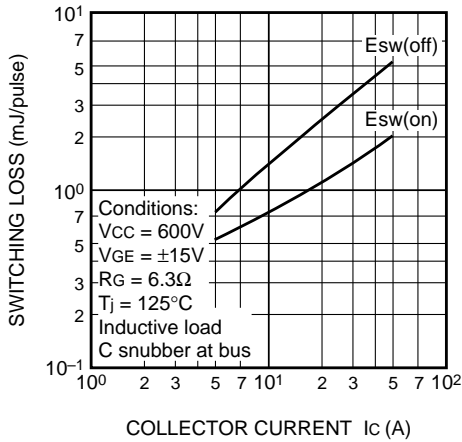

SWITCHING LOSS vs. GATE RESISTANCE (TYPICAL)

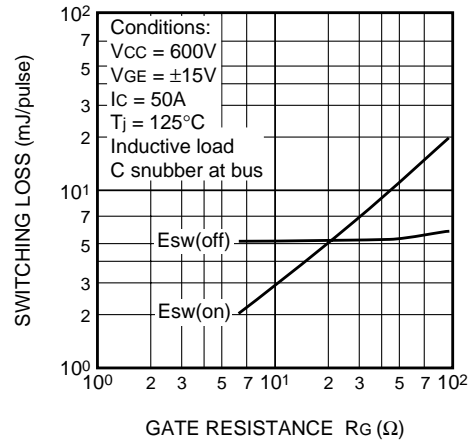

RECOVERY LOSS vs. IE (TYPICAL)

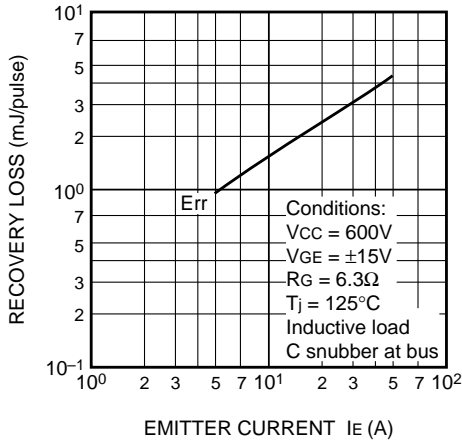

RECOVERY LOSS vs. GATE RESISTANCE (TYPICAL)

