

Features

- Small Size and Low Profile
- Industry Standard SOIC-8 SMT Plastic Package
- Excellent Amplitude and Phase Balance
- Superior Repeatability
- Typical Insertion Loss 0.7 dB
- Typical Isolation 21 dB
- 1 Watt Power Handling
- Lead-Free SOIC-8 Package
- 100% Matte Tin Plating over Copper
- Halogen-Free “Green” Mold Compound
- 260°C Reflow Compatible
- RoHS* Compliant Version of DS52-0002

Description

M/A-COM’s MAPDCC0002 is an IC-based monolithic power divider in a low cost SOIC-8 plastic package. This 2-way power divider is ideally suited for applications where small size, low insertion loss, superior phase/amplitude tracking and low cost are required. Typical applications include base station switching networks and other communication applications where size and PCB real estate are a premium. Available in tape and reel.

The MAPDCC0002 is fabricated using a passive-integrated circuit process. The process features full-chip passivation for increased performance and reliability.

Ordering Information

Part Number	Package
MAPDCC0002	Bulk Packaging
MAPDCC0002TR	1000 piece reel
MAPDCC0002-TB	Sample Test Board

Note: Reference Application Note M513 for reel size information.

Functional Block Diagram

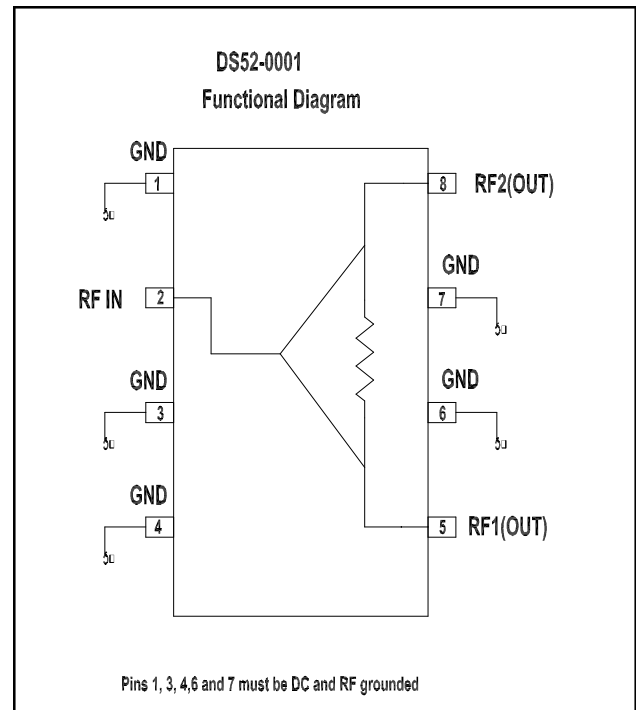

Pin Configuration

Pin No.	Function
1	GND
2	RF-IN
3	GND
4	GND
5	RF-1 (out)
6	GND
7	GND
8	RF-2 (out)

* Restrictions on Hazardous Substances, European Union Directive 2002/95/EC.

Electrical Specifications¹: T_A = 25°C

Parameter	Test Conditions	Frequency	Units	Min	Typ	Max
Insertion Loss	Above 3.0 dB	1850 - 1990	dB	—	0.5	0.6
Isolation	—	1850 - 1990	dB	15	21	—
VSWR	Input RL	1850 - 1990	Ratio	—	1.2:1	1.4:1
VSWR	Output RL	1850 - 1990	Ratio	—	1.4:1	1.6:1
Amplitude Balance	—	1850 - 1990	dB	—	0.05	0.15
Phase Balance	—	1850 - 1990	Deg.	—	1.0	3.0

1. All specifications apply with a 50-ohm source and load impedance.

Absolute Maximum Ratings^{2,3}

Parameter	Absolute Maximum
Input Power ⁴	1W CW
Operating Temperature	-40°C to +85°C
Storage Temperature	-65°C to +150°C

- Exceeding any one or combination of these limits may cause permanent damage to this device.
- M/A-COM does not recommend sustained operation near these survivability limits.
- With internal load dissipation of 0.125W maximum

Handling Procedures

Please observe the following precautions to avoid damage:

Static Sensitivity

GMIC Circuits are sensitive to electrostatic discharge (ESD) and can be damaged by static electricity. Proper ESD control techniques should be used when handling these devices.

Recommended PCB Configuration

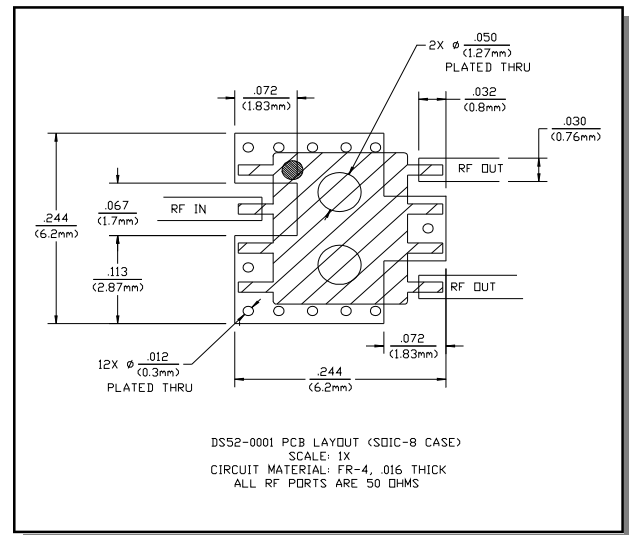

Typical Performance Curves

Insertion Loss vs. Frequency
(above theoretical split loss)

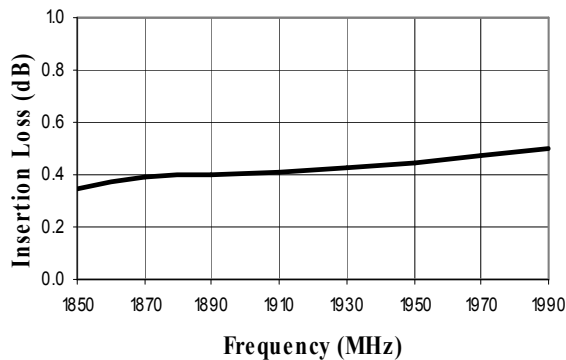

Isolation vs. Frequency

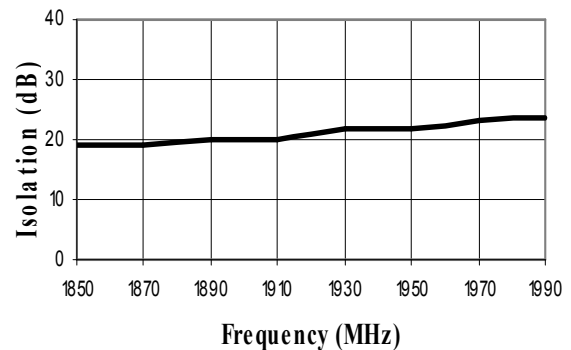

Input VSWR vs. Frequency

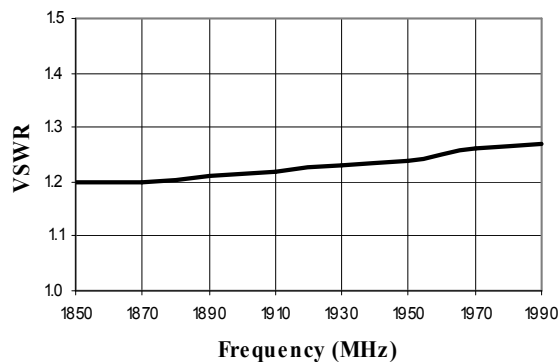

Output VSWR vs. Frequency

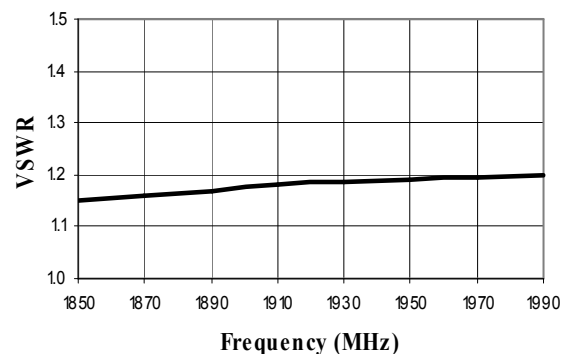

Lead-Free, SOIC-8[†]

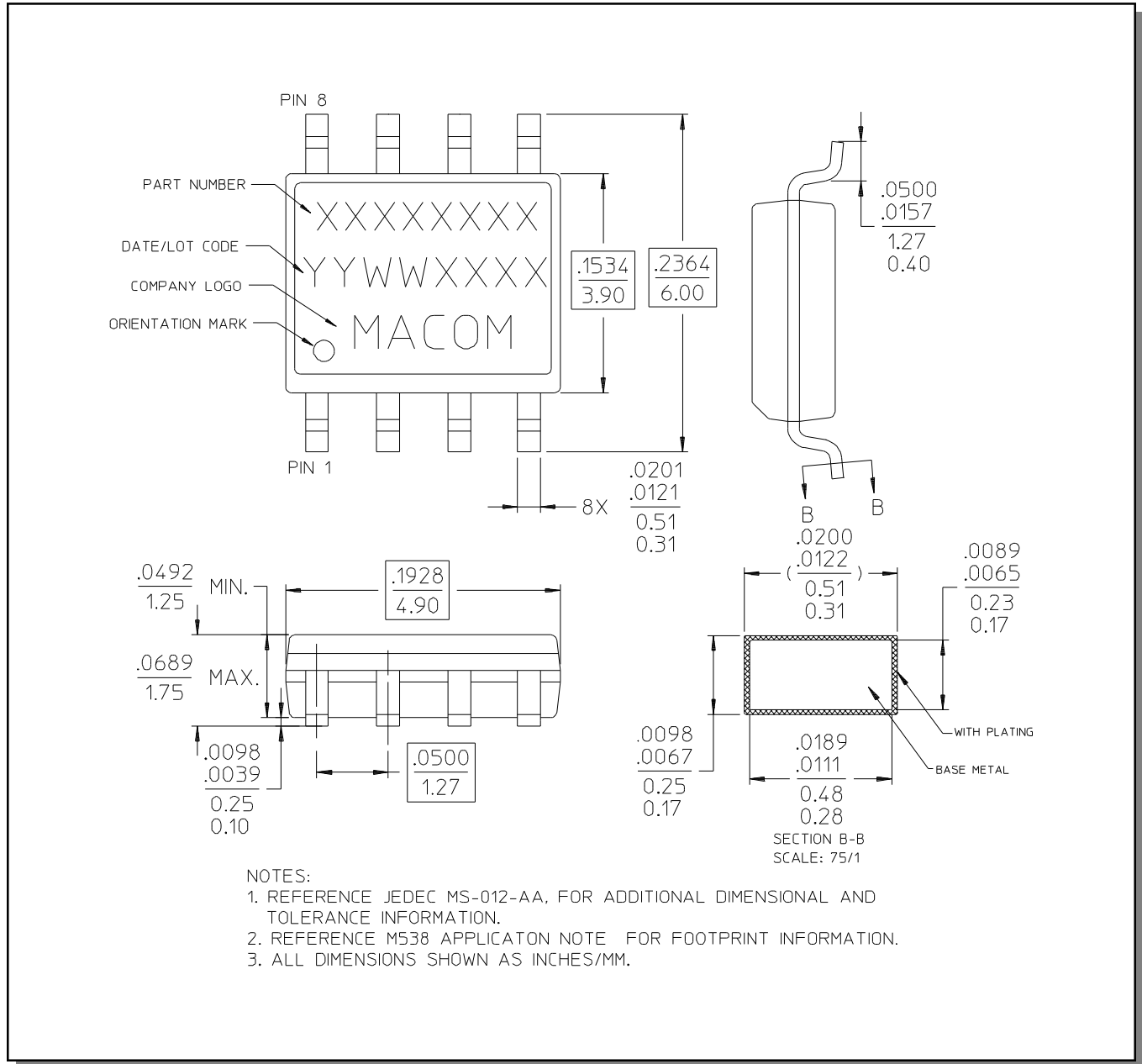

[†] Reference Application Note M538 for lead-free solder reflow recommendations.