

1. PART NO. EXPRESSION :

PSB0603-101KZF
 (a) (b) (c) (d)(e)(f)

- (a) Series code
- (b) Dimension code
- (c) Inductance code : 101 = 100uH
- (d) Tolerance code : K = ±10%, M = ±20%
- (e) X, Y, Z : Standard part
- (f) F : Lead Free

2. CONFIGURATION & DIMENSIONS :

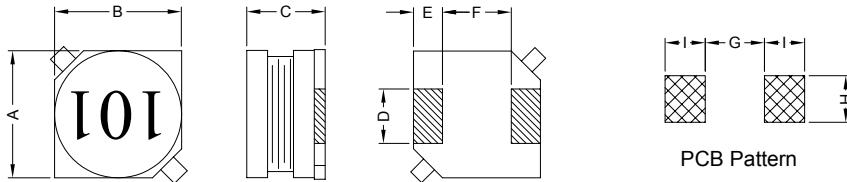

Unit:m/m

A	B	C	D	E	F	G	H	I
6.0±0.3	6.0±0.3	2.9±0.3	2.0±0.2	1.5±0.2	3.0±0.2	2.8 Ref.	2.2 Ref.	1.9 Ref.

3. SCHEMATIC :

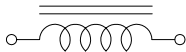

4. MATERIALS :

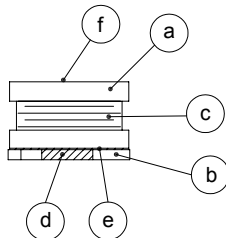

- (a) Core : DR Ferrite Core
- (b) Base : LCP
- (c) Wire : Enamelled Copper Wire
- (d) Terminal : Tinned Copper Plate
- (e) Adhesive : Epoxy
- (f) Ink : Bon Margue

5. GENERAL SPECIFICATION :

- a) Temp. rise : 40°C Max.
- b) Rated current : Base on temp. rise & ΔL/L0A = 10% Max.
- c) Storage temp. : -40°C to +125°C
- d) Operating temp. : -40°C to +85°C
- e) Resistance to solder heat : 260°C.10 secs



RoHS Compliant

NOTE : Specifications subject to change without notice. Please check our website for latest information.

05.05.2008



SUPERWORLD ELECTRONICS (S) PTE LTD

6. ELECTRICAL CHARACTERISTICS :

Part No.	Inductance (μ H)	Q Ref.	Test Frequency (Hz)	SRF (MHz) Typ.	RDC (m Ω) Max.	IDC (A) Max.
PSB06031R2MZF	1.2 \pm 20%	30	1V / 100K	150.0	25	2.80
PSB06031R5MZF	1.5 \pm 20%	30	1V / 100K	135.0	28	2.60
PSB06032R2MZF	2.2 \pm 20%	30	1V / 100K	85.0	30	2.30
PSB06033R3MZF	3.3 \pm 20%	30	1V / 100K	70.0	55	2.00
PSB06034R7MZF	4.7 \pm 20%	25	1V / 100K	60.0	65	1.85
PSB06036R8MZF	6.8 \pm 20%	30	1V / 100K	45.0	90	1.65
PSB0603100MZF	10.0 \pm 20%	25	1V / 100K	35.0	115	1.45
PSB0603120MZF	12.0 \pm 20%	30	1V / 100K	33.0	150	1.20
PSB0603150MZF	15.0 \pm 20%	25	1V / 100K	32.0	180	1.15
PSB0603180MZF	18.0 \pm 20%	30	1V / 100K	30.0	230	1.05
PSB0603220MZF	22.0 \pm 20%	30	1V / 100K	28.0	250	1.00
PSB0603270MZF	27.0 \pm 20%	30	1V / 100K	27.0	350	0.95
PSB0603330KZF	33.0 \pm 10%	35	1V / 100K	22.0	380	0.90
PSB0603390KZF	39.0 \pm 10%	25	1V / 100K	20.0	410	0.80
PSB0603470KZF	47.0 \pm 10%	40	1V / 100K	16.0	430	0.75
PSB0603560KZF	56.0 \pm 10%	40	1V / 100K	15.0	620	0.70
PSB0603680KZF	68.0 \pm 10%	40	1V / 100K	13.0	710	0.60
PSB0603820KZF	82.0 \pm 10%	50	1V / 100K	11.0	730	0.50
PSB0603101KZF	100.0 \pm 10%	45	1V / 100K	10.0	1050	0.48
PSB0603121KZF	120.0 \pm 10%	40	1V / 100K	9.5	1180	0.45
PSB0603151KZF	150.0 \pm 10%	50	1V / 100K	9.0	1800	0.40
PSB0603181KZF	180.0 \pm 10%	50	1V / 100K	8.0	1950	0.35
PSB0603221KZF	220.0 \pm 10%	55	1V / 100K	7.0	2960	0.30
PSB0603271KZF	270.0 \pm 10%	55	1V / 100K	6.5	3450	0.28
PSB0603331KZF	330.0 \pm 10%	50	1V / 100K	6.0	3800	0.26
PSB0603391KZF	390.0 \pm 10%	50	1V / 100K	5.0	4000	0.24
PSB0603471KZF	470.0 \pm 10%	60	1V / 100K	4.8	4400	0.22
PSB0603561KZF	560.0 \pm 10%	60	1V / 100K	4.4	6200	0.20
PSB0603681KZF	680.0 \pm 10%	60	1V / 100K	4.0	6800	0.18
PSB0603821KZF	820.0 \pm 10%	60	1V / 100K	3.8	12000	0.16
PSB0603102KZF	1000.0 \pm 10%	60	1V / 100K	3.5	13500	0.14

NOTE : Specifications subject to change without notice. Please check our website for latest information.

05.05.2008



SUPERWORLD ELECTRONICS (S) PTE LTD

7. CHARACTERISTICS CURVES :

@ TEMP. RISE VS. DC SUPERPOSITION RESPONSE CURVE

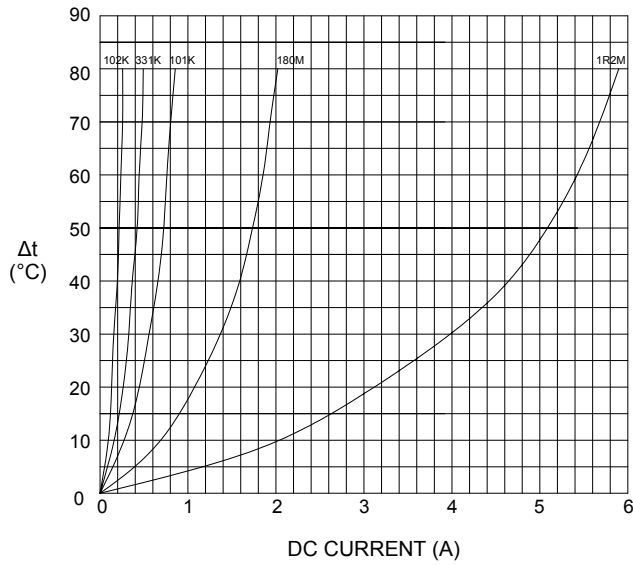

@ INDUCTANCE VS. FREQUENCY RESPONSE CURVE

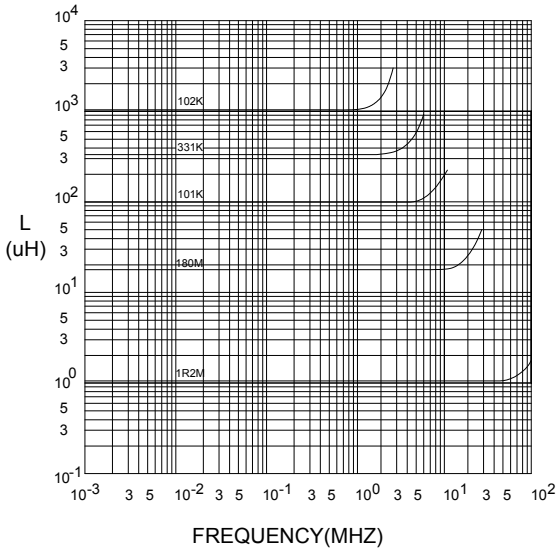

@ INDUCTANCE VS. DC SUPERPOSITION RESPONSE CURVE

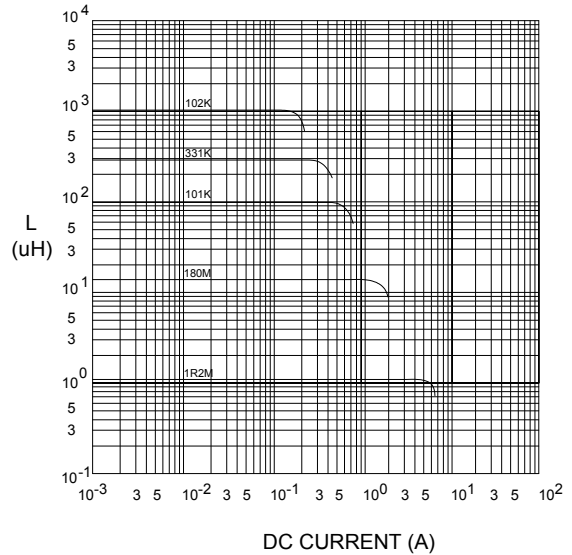

NOTE : Specifications subject to change without notice. Please check our website for latest information.



RoHS Compliant

05.05.2008



SUPERWORLD ELECTRONICS (S) PTE LTD

RECOMMENDED SOLDERING CONDITIONS REFLOW SOLDERINGS

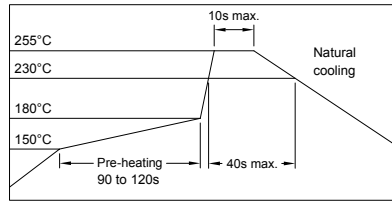

8. PACKAGING INFORMATION :

(1) CONFIGURATION

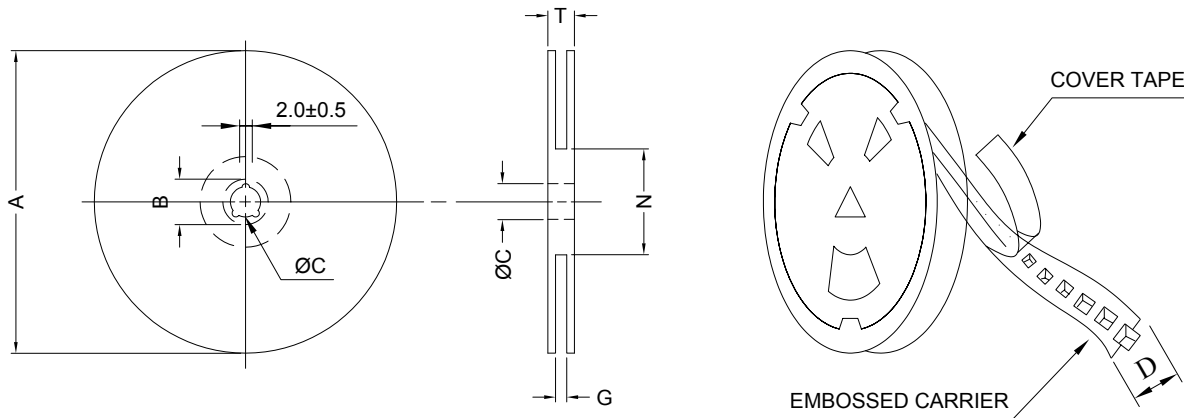

* CARRIER TAPE WIDTH : D

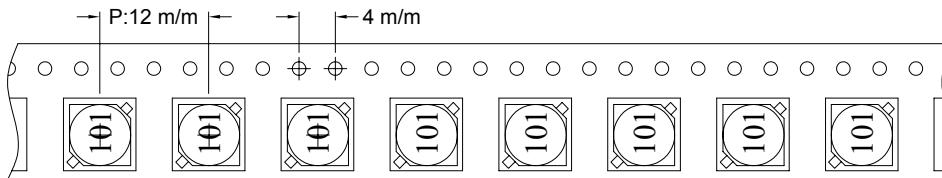

(2) DIMENSIONS

Unit:m/m

STYLE	A	B	C	D	G	N	T
13-16	330	21±0.8	13	16	18 ⁺⁰	50 ⁻⁰	22.4

(3) Q'TY & G.W. PER PACKAGE

SERIES	INNER : REEL			OUTER : CARTON		
	Q'TY (PCS)	G.W. (gw)	STYLE	Q'TY (PCS)	G.W. (Kg)	SIZE (cm)
PSB0603	1000	450	13-16	6000	6.2	40 x 40 x 24



RoHS Compliant

NOTE : Specifications subject to change without notice. Please check our website for latest information.

05.05.2008



SUPERWORLD ELECTRONICS (S) PTE LTD

9. RELIABILITY AND TEST CONDITION :

TEST ITEM	SPECIFICATION	TEST CONDITION
SOLDERABILITY	MORE THAN 90% OF THE TERMINAL ELECTRODE SHALL BE COVERED WITH FRESH SOLDER.	PREHEAT : 125±25°C FOR 60 SECONDS SOLDER : 99%Sn/0.3%Ag/0.7%Cu OR EQUIVALENT SOLDER TEMP. : 245±5°C FLUX : ROSIN DIP TIME : 4±1 SECONDS
THERMAL SHOCK TEST (TEMP. CYCLE)	INDUCTANCE SHALL NOT CHANGE MORE THAN ±20%	ROOM TEMP. → -25±2°C 15 MINUTES 30 MINUTES ROOM TEMP. → 85±2°C 15 MINUTES 30 MINUTES TOTAL : 50 CYCLES
HUMIDITY RESISTANCE TEST		TEMPERATURE : 40±2°C HUMIDITY : 90 ~ 95% APPLIED CURRENT : PER SPEC. TIME : 500 HOURS
HIGH TEMP. RESISTANCE TEST		TEMPERATURE : 85±2°C APPLIED CURRENT : PER SPEC. TIME : 500 HOURS



RoHS Compliant

NOTE : Specifications subject to change without notice. Please check our website for latest information.

05.05.2008



SUPERWORLD ELECTRONICS (S) PTE LTD

10. UL CARD :

OBMW2 **November 30, 2000**
Magnet Wire - Component
PACIFIC ELECTRIC WIRE & CABLE (SHENZHEN) CO LTD **E201757**
607 BAOLONG INDUSTRIAL ESTATE LONGGANG, SHENZHEN
GUANGDONG CHINA

Mtl Dsg	Coating Type	TC	ANSI Type	TI
UEW/U	BC Polyurethane	—	—	130
PEW/U	Polyester	—	MW5-C	155°C
PEWH/U	Modified Polyester	—	MW30-C	180
PEW-NY/U	Polyester	Polyamide	MW24-C	155
HAI/U	Polyester(Amide)(Imide)	Polyamideimide	MW35,73	200
UEW-NY/U	Polyurethane	Polyamide	MW80-C	155
			MW28-C	130

Marking: Company name and material designation or marked designation on package or reel, and Recognized Component Mark.

See General Information Preceding These Recognitions

1/3/2001 **Underwriters Laboratories Inc.** **Card 1 of 2**

SUMITOMO CHEMICAL CO LTD **E54705 (M)**
5-33 KITAHAMA 4-CHOME CHUO-KO, OSAKA JAPAN

Mtl Dsg	Col	Min Thk mm	UL94 Flame Class	Elec	RTI		w/o Imp	H W I	H A I	H V T R	D 4 5	C T I
					with Imp	Mech						
Liquid crystal polyester (LCP), designated "EKONOL" or "SUMIKASUPER", furnished in the form of pellets, (Contd)												
E4008 , E400X	NC , BK	0.30	94V-0	130	130	130	—	—	—	—	—	—
		0.75	94V-0	130	130	130	3	4	—	—	—	—
		1.5	94V-0	130	130	130	2	4	—	—	—	—
		3.0	94V-0	130	130	130	1	4	0	5	4	—
E4008	NC , WT , BK	0.30	94V-0	130	130	130	—	—	—	—	—	—
		0.75	94V-0	220	180	220	3	4	—	—	—	—
		1.5	94V-0	220	200	240	2	4	—	—	—	—
		3.0	94V-0	220	200	240	1	4	0	5	4	—
E4010	NC , BK	0.30	94V-0	130	130	130	—	—	—	—	—	—
		0.75	94V-0	220	180	220	3	4	—	—	—	—
		1.5	94V-0	220	200	240	2	4	—	—	—	—
		3.0	94V-0	220	200	240	1	4	0	5	4	—
E400(Y)L , E4008L	NC , BK	0.30	94V-0	130	130	130	—	—	—	—	—	—
		0.75	94V-0	130	130	130	3	4	—	—	—	—
		1.5	94V-0	130	130	130	2	4	—	—	—	—
		3.0	94V-0	130	130	130	1	4	0	5	4	—
E4810	NC , BK	0.30	94V-0	130	130	130	—	—	—	—	—	—
		0.75	94V-0	130	130	130	0	4	—	—	—	—
		1.5	94V-0	130	130	130	0	4	—	—	—	—
		3.0	94V-0	130	130	130	1	4	0	5	4	—

(X) Denotes any number 1 thru 9.
(Y) Denotes any number 1 thru 7.



RoHS Compliant

NOTE : Specifications subject to change without notice. Please check our website for latest information.

05.05.2008



SUPERWORLD ELECTRONICS (S) PTE LTD