



# PRODUCT SPECIFICATION

**Model No : CSLR-U319YL4-A0**

Descriptions:	
■ LED Type	: Lighting LED Lamp
■ LED Package	: Round LED Lamp
■ Emitting Color	: Yellow
■ Viewing Angle	: 50°
■ No Stopper	



CUSTOMER APPROVED SIGNATURES	APPROVED BY	CHECKED BY	PREPARED BY

**CHINA SEMICONDUCTOR CORPORATION**  
Address: 2FL. NO.909, Chung-Cheng Road,  
Chung-Ho City Taipei Hsien, Taiwan.

**OPTO PLUS TECHNOLOGIES CO.,LTD**  
Address: 696 Shun jiang Rd., Ji Shan St. Shaoxing,  
ZheJiang, China

Tel: 886-2-2223-9696  
Fax: 886-2-2223-9377

Tel: 86-0575-88623888  
Fax: 86-0575-88623112



**Model No : CSLR-U319YL4-A0**

**Features -**

1. Low Power Consumption.
2. High Luminous Output
3. High Reliability and Solid Performance
4. Optimal Optical/Mechanical Design
5. Rohs Compliant

**Device Selection Guide -**

Part No.	Chip		LED Lens
	Material	Emitted Color	
CSLR-U319YL4-A0	AlInGaP	Yellow	Water Transparent

**Package Outline Dimensions -**

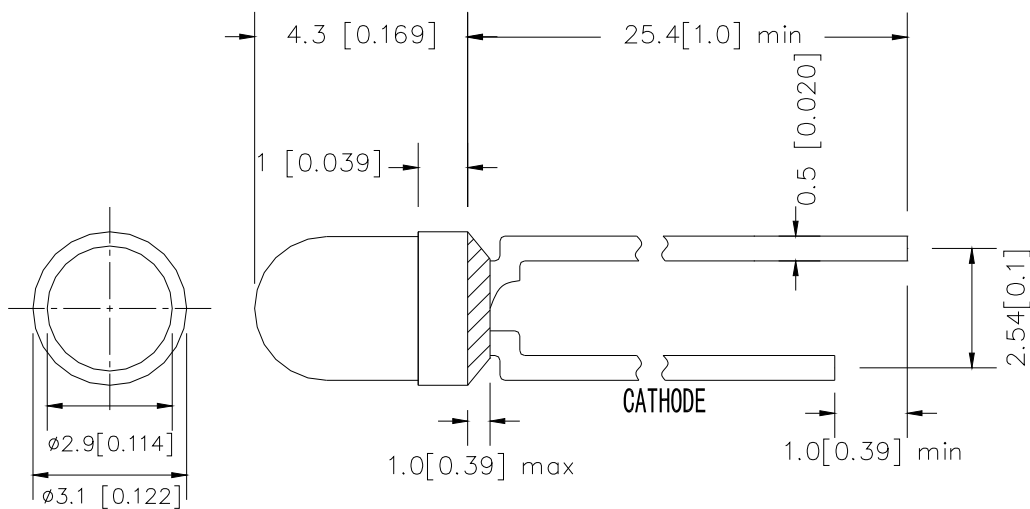

\* Tolerance :  $\pm \frac{0.01}{0.25}$  Unit :  $\pm \frac{\text{inch}}{\text{mm}}$



Model No : CSLR-U319YL4-A0

■ Absolute Maximum Rating -

(Ta=25°C)

Parameter	Symbol	Rating	Unit
Power Dissipation	Pd	52	mW
Forward Current (DC)	IF	30	mA
Peak Forward Current *	IFP	100	mA
Reverse Voltage	VR	5	V
Operating Temp.	Topr	-30 ~ +80	°C
Storage Temp.	Tstg	-40 ~ +100	°C
Lead Soldering Temperature	Tsol	Max. 260°C for 5 sec Max. (3mm from the epoxy body)	

\* Pulse width  $\leq 0.1$  msec. duty  $\leq 1/10$

■ Electro-optical Characteristics

(Ta=25°C)

Parameter	Symbol	Min.	Typ.	Max.	Unit	Condition
Forward Voltage	VF	-----	2.1	2.6	V	IF=20mA
Luminous Intensity	Iv	3000	5900	-----	mcd	
Dominant Wavelength	$\lambda D$	-----	590	-----	nm	
Viewing Angle	2 $\theta$ 1/2	-----	50	-----	deg	
Reverse Current	IR	-----	-----	50	$\mu A$	VR=5V



**Model No : CSLR-U319YL4-A0**

**■ Luminous Intensity Rank Limits (  $I_f = 20\text{mA}$  )**

unit : mcd

Part No. Code	CSLR-U319YL4-A0	
	min.	max.
S	3000	3900
T	3900	5100
U	5100	6600
V	6600	8600
W	8600	11200

**■ Dominant Wavelength Rank Limits (  $I_f = 20\text{mA}$  )**

unit : nm

Part No. Code	CSLR-U319YL4-A0	
	min.	max.
Y3	589.5	592
Y4	592	594.5
Y5	594.5	597

**■ Forward Voltage Rank Limits (  $I_f = 20\text{mA}$  )**

unit : v

Part No. Code	CSLR-U319YL4-A0	
	min.	max.
B	1.6	1.8
C	1.8	2.0
D	2.0	2.2
E	2.2	2.4
F	2.4	2.6

Notes:

1. Tolerance of measurement of luminous intensity :±15%
2. Tolerance of measurement of Color Coordinates :±0.01
3. Tolerance of measurement of forward voltage :±0.05v
4. All data are measured by CSC's test equipment.
5. One delivery will include several color rank, VF rank and Iv ranks of the products.
6. The quantity-ratio of the ranks is decided by CSC.
7. Please confirm with CSC salesman,if your request different form standard specification.



Model No : CSLR-U319YL4-A0

■ Typical Electrical / Optical Characteristics Curves -

(Ta = 25°C Unless Otherwise Noted)

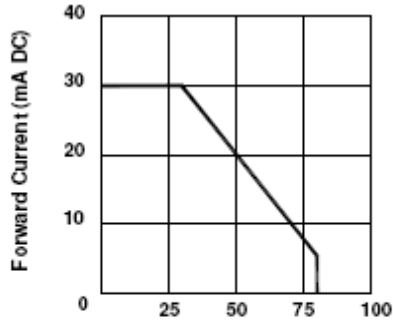

Ambient Temperature Ta (°C)  
Fig 1. Forward Current  
Vs. Ambient Temperature

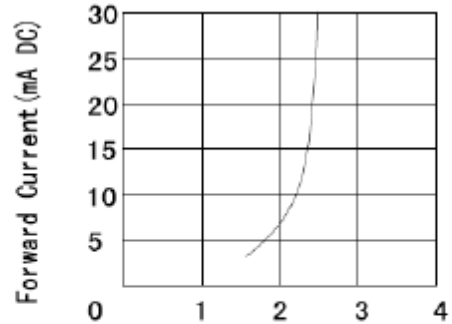

Forward Voltage VF (V)  
Fig. 2 Forward Current  
Vs. Forward Voltage

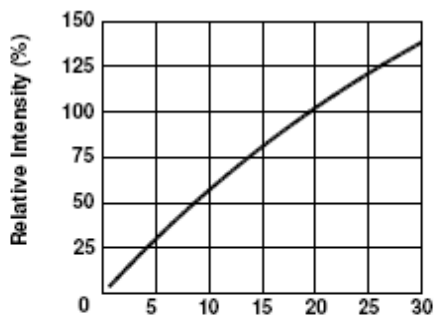

Forward Current IF (mA DC)  
Fig 3. Relative Intensity  
Vs. Forward Current

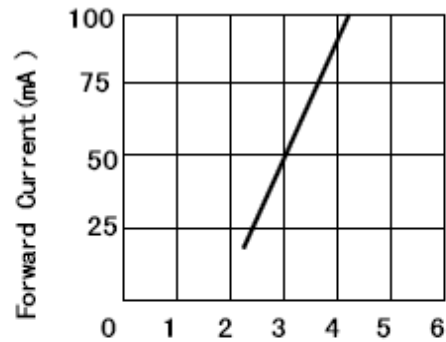

Forward Voltage (V)  
Fig. 4 Peak Forward Voltage  
Vs. Forward Current  
(100us test pulse, 1% duty cycle)

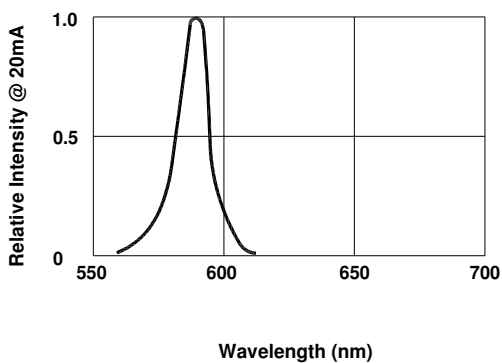

Fig 5. Relative Intensity Vs. Wavelength

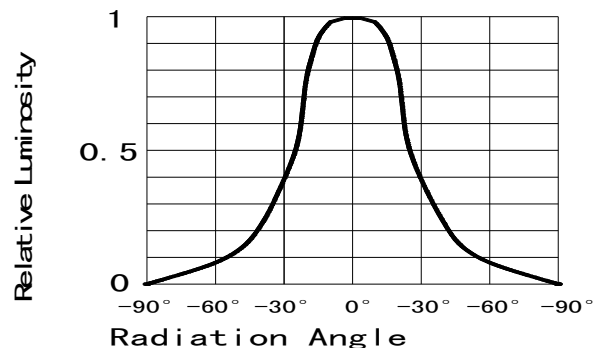

Fig 6. Relative Luminous Intensity vs. Radiation Angle



Model No : CSLR-U319YL4-A0

## ■ Precautions For Use -

### 1. Recommended Soldering conditions

#### Wave Soldering

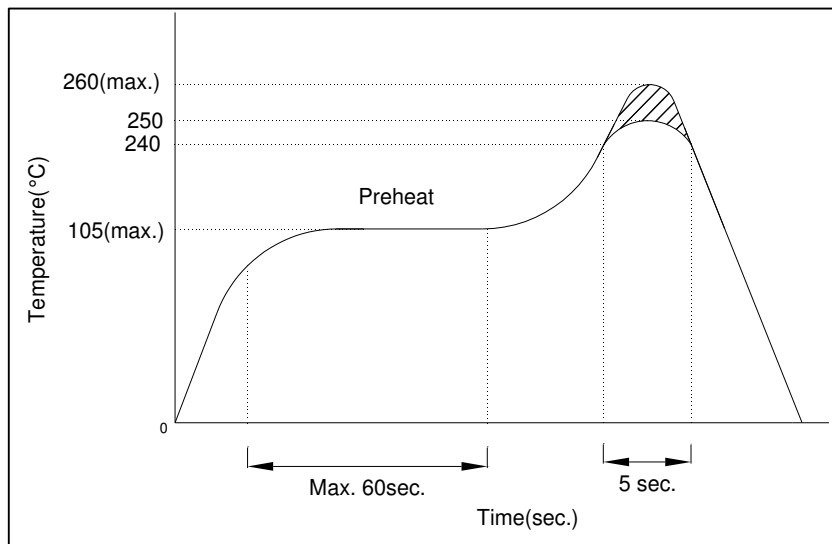

### 2. Soldering Iron

Basic SPEC. is  $\leq 5$ sec. When  $260^{\circ}\text{C}$ . If temperature is higher, time should be shorter ( $+10^{\circ}\text{C} \rightarrow -1$ sec.). Power dissipation of iron should be smaller than 15W, and temperature should be controllable. Surface temperature of the device should be under  $230^{\circ}\text{C}$ .

### 3. Static Electricity

- Static electricity or surge voltage damages LEDs..  
It is recommended that a wrist band or an anti-electrostatic glove be used when handling the LEDs.
- All devices, equipment and machinery must be properly grounded. It is recommended that measures be taken against surge voltage to the equipment that mounts the LEDs.

Note: The specifications are subject to change without notice. Please contact us for updated information.