



Data Sheet

M-FIAM9

Military COTS 28 Vin Filter Input Attenuator Module

Model Number: M-FIAM9M21*



Shown actual size:
2.28 x 2.2 x 0.5 in
57,9 x 55,9 x 12,7 mm

Features

- EMI filtering-MIL-STD-461E
- Transient protection-MIL-STD-704A/E/F, MIL-STD-1275A/B/D
- Environments-MIL-STD-810, MIL-STD-202
- Environmental stress screening
- Low profile mounting options
- Output power up to 500 W
- Output current up to 18 A
- Mini sized package
- Inrush current limiting

Product Highlights

The M-FIAM9 is a DC front-end module that provides EMI filtering and transient protection. The M-FIAM9 enables designers using Vicor's Maxi, Mini, Micro Series 24 V & Maxi Series 28 V DC-DC converters to meet conducted emission / conducted susceptibility per MIL-STD-461E; and input transients per MIL-STD-704A/E/F and MIL-STD-1275A/B/D. The M-FIAM9 accepts an input voltage of 10 – 36 Vdc and delivers output power up to 500 W.

M-FIAM9 is housed in an industry standard "half brick" module measuring 2.28" x 2.2" x 0.5" and depending upon model selected, may be mounted onboard or inboard for height critical applications.

Compatible Products

- Maxi, Mini, Micro Series 24 V Input DC-DC converters
- Maxi Series 28 V Input DC-DC converters

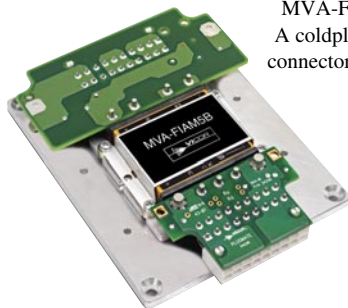

MVA-FIAM9:
A coldplate and connector option.

The MVA-FIAM9 provides a coldplate and connector option for use with either 24 V input Maxi, Mini, Micro series DC-DC converters or VIPAC Arrays.

Absolute Maximum Rating

Parameter	Rating	Unit	Notes
+In to -In	36	Vdc	Continuous
	100	Vdc	See Fig.1
Mounting torque	5 (0.57)	in-lbs	6 each, #4-40 or M3
Pin soldering temperature	500 (260)	°F(°C)	<5 sec; wave solder
	750 (390)	°F(°C)	<7 sec; hand solder

Thermal Resistance and Capacity

Parameter	Min	Typ	Max	Unit
Baseplate to sink flat, greased surface		0.16		°C/Watt
		0.1		°C/Watt
Baseplate to ambient Free convection		7.9		°C/Watt
	1000 LFM	2.2		°C/Watt

MTBF per MIL-HDBK-217F (M-FIAM9M21)

Temperature	Environment	MTBF	Unit
25°C	Ground Benign: G.B.	3,582	1,000 Hrs
50°C	Naval Sheltered: N.S.	644	1,000 Hrs
65°C	Airborne Inhabited Cargo: A.I.C.	505	1,000 Hrs

Part Numbering*

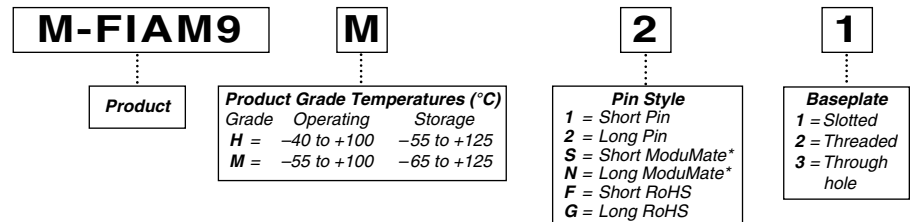

*Compatible with SurfMate and InMate socketting system.

MVA-FIAM9 (Coldplate and connector option)

H-Grade (-40°C to +100°C operation): MVA-FIAM9H, MVA-FIAM9H-C (On / Off control enabled)
M-Grade (-55°C to +100°C operation): MVA-FIAM9M, MVA-FIAM9M-C (On / Off control enabled)

SPECIFICATIONS

(typical at $T_{BP} = 25^{\circ}\text{C}$, nominal line and 75% load, unless otherwise specified)

INPUT SPECIFICATIONS

Parameter	Min	Typ	Max	Unit	Notes
Input voltage	10	28	36	Vdc	Continuous
Inrush limiting			0.007	A/ μF	
Transient immunity			100	Vdc	50 ms per MIL-STD-1275A/B/D, continuous operation
			250	Vdc	70 μs per MIL-STD-1275A/B/D, continuous operation
			70	Vdc	20 ms per MIL-STD-704A, continuous operation
			50	Vdc	12.5 ms per MIL-STD-704E/F, continuous operation

OUTPUT SPECIFICATIONS

Parameter	Min	Typ	Max	Unit	Notes
Output power			500	W	
Output current			18	A	
Efficiency	96	97		%	
Internal voltage drop		0.85	1.5	V	500 W, 25°C baseplate
External capacitance	330		1000	μF	See Figure 4 on page 4 50 V

CONTROL PIN SPECIFICATIONS

Parameter	Min	Typ	Max	Unit	Notes
ON/OFF control					
Enable (ON)	0.0		1.0	Vdc	Referenced to – Vout
Disable (OFF)	3.5		5.0	Vdc	100 k Ω internal pull up resistor

SAFETY SPECIFICATIONS

Parameter	Min	Typ	Max	Unit	Notes
Dielectric withstand		1,500	Vrms		Input/Output to Base
		2,121	Vdc		Input/Output to Base

EMI

Standard	Test Procedure	Notes
MIL-STD-461E		
Conducted emissions:	CE101, CE102	When using with V28 series converters a 27 μH inductor is needed between the filter and converter for compliance below 30% of rated power.
Conducted susceptibility:	CS101, CS114, CS115, CS116	

GENERAL SPECIFICATIONS

Parameter	Min	Typ	Max	Unit	Notes
Weight			3.3 (94)	Ounces (grams)	
Warranty			2	Years	

SPECIFICATIONS (CONT.)

■ ENVIRONMENTAL QUALIFICATION

Altitude
MIL-STD-810F, Method 500.4, Procedure I & II, 40,000 ft. and 70,000 ft. Operational.
Explosive Atmosphere
MIL-STD-810F, Method 511.4, Procedure I, Operational.
Vibration
MIL-STD-810F, Method 514.5, Procedure I, Category 14, Sine and Random vibration per Table 514.5C for Helicopter AH-6J Main Rotor with overall level of 5.6 G rms for 4 hours per axis. MIL-STD-810F, Method 514.5C, General Minimum Integrity Curve per Figure 514.5C-17 with overall level of 7.7 G rms for 1 hour per axis.
Shock
MIL-STD-810F, Method 516.5, Procedure I, Functional Shock, 40 g. MIL-S-901D, Lightweight Hammer Shock, 3 impacts / axis, 1,3,5 ft. MIL-STD-202F, Method 213B, 60 g, 9 ms half sine. MIL-STD-202F, Method 213B, 75 g, 11ms Saw Tooth Shock.
Acceleration
MIL-STD-810F, Method 513.5, Procedure II, table 513.5-II, Operational, 2-7 g, 6 directions.
Humidity
MIL-STD-810F, Method 507.4.
Solder Test
MIL-STD-202G, Method 208H, 8 hour aging.

■ ENVIRONMENTAL STRESS SCREENING

Parameter	H-Grade	M-Grade
Operating temperature	-40°C to +100°C	-55°C to +100°C
Storage temperature	-55°C to +125°C	-65°C to +125°C
Temperature cycling*	12 cycles -65°C to +100°C	12 cycles -65°C to +100°C
Ambient test @ 25°C	Yes	Yes
Power cycling burn-in	12 hours, 29 cycles	24 hours, 58 cycles
Functional and parametric ATE tests	-40°C and +100°C	-55°C and +100°C
Hi-Pot test	Yes	Yes
Visual inspection	Yes	Yes
Test data	vicorpower.com	vicorpower.com

*Temperature cycled with power off, 17°C per minute rate of change.

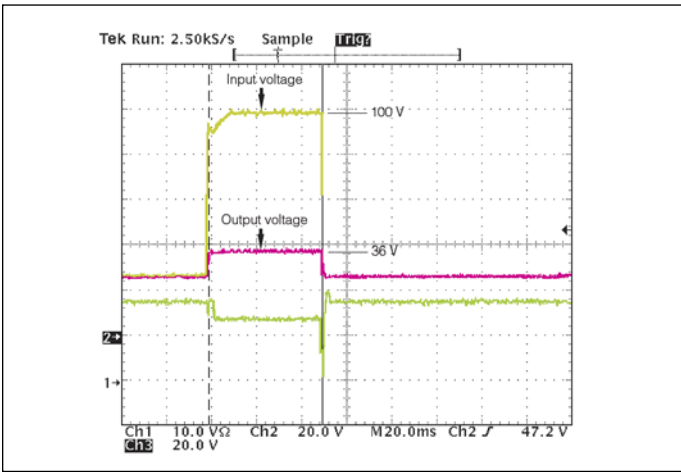

Figure 1 — Transient Immunity: M-FIAM9 output response to an input transient.

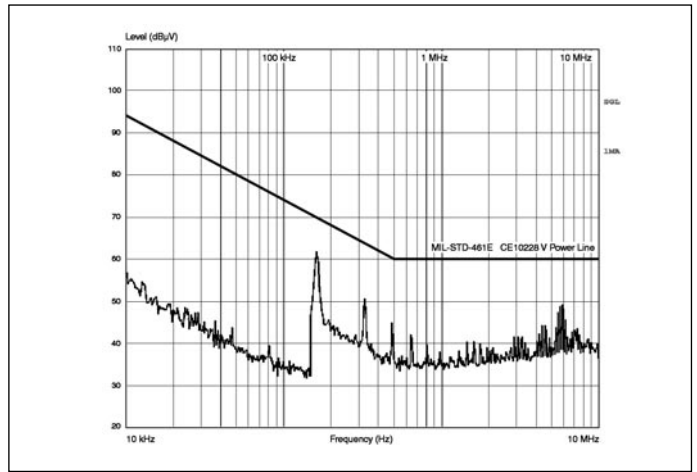

Figure 2 — Conducted Noise; M-FIAM9 and Model V28A12M200B DC-DC converter operating at 28 Vdc, 200 W.

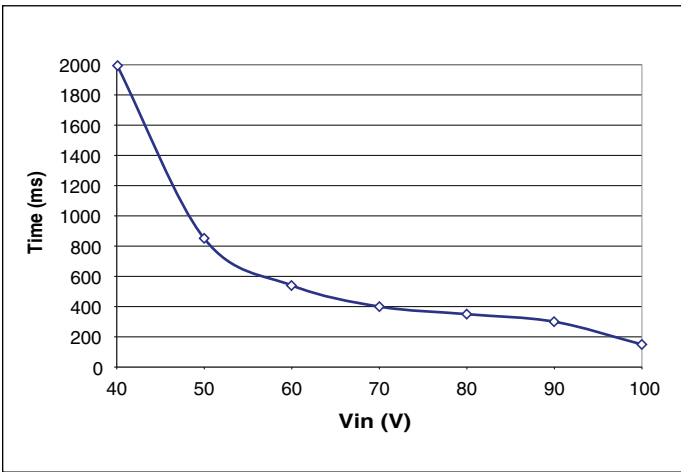

Figure 3 — Shut down time of M-FIAM9 vs. Overvoltage

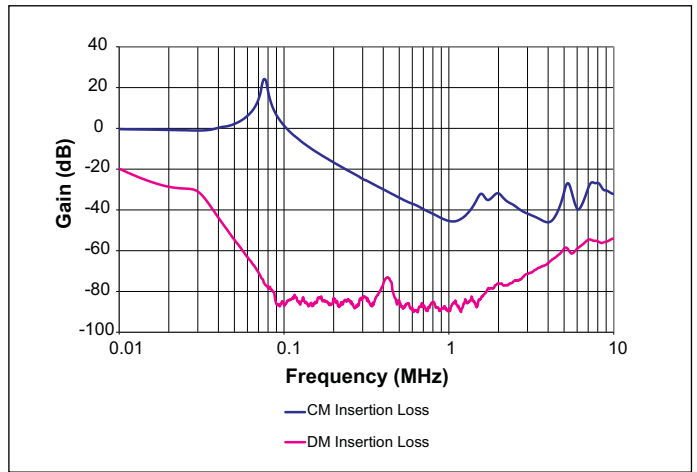

Figure 4 — M-FIAM9 insertion loss

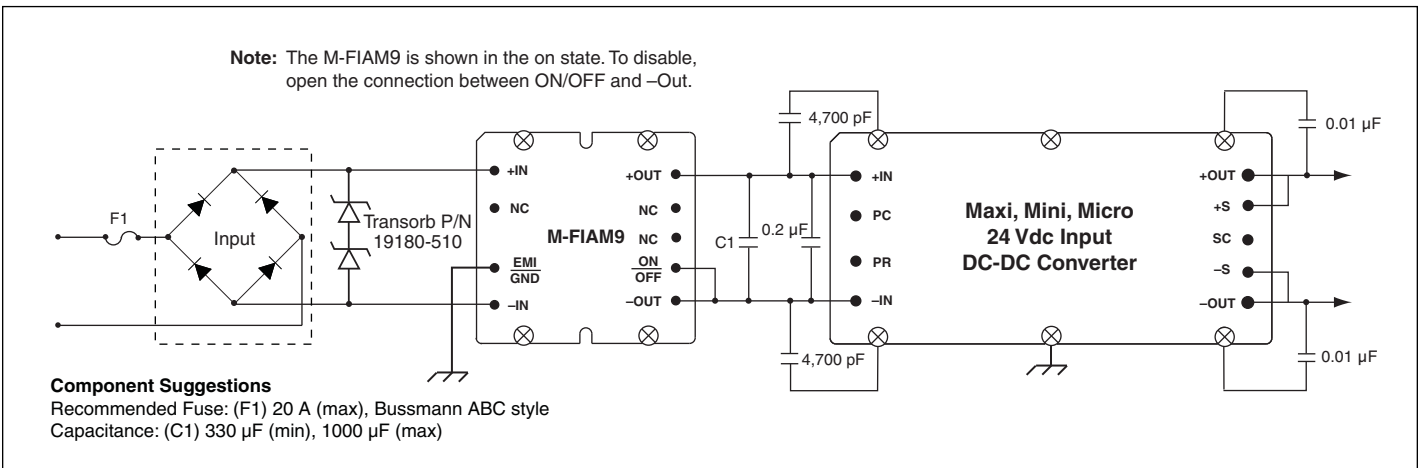

Figure 5— Transient, Surge Protection and Recommended Reverse Polarity Protection.

MECHANICAL DRAWINGS

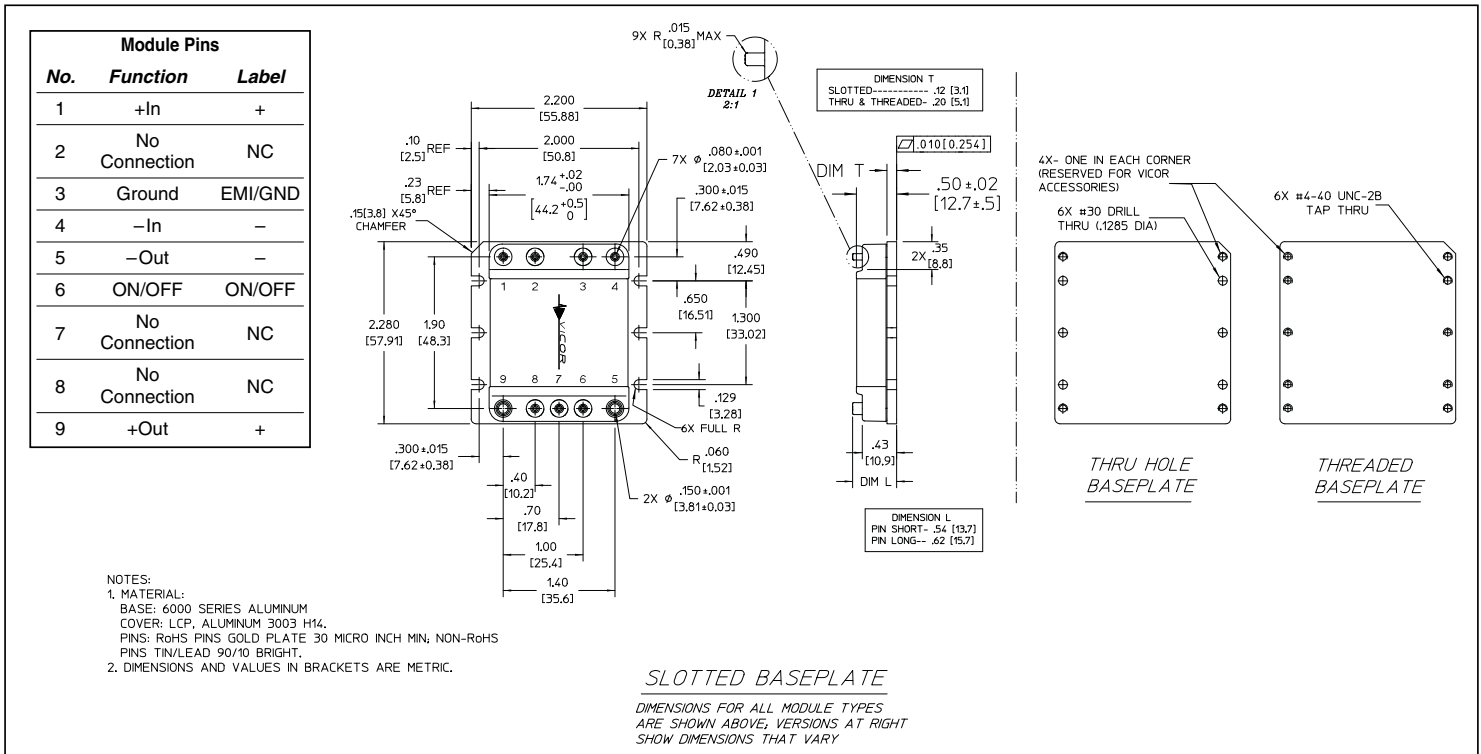

Figure 6 — Mechanical diagram

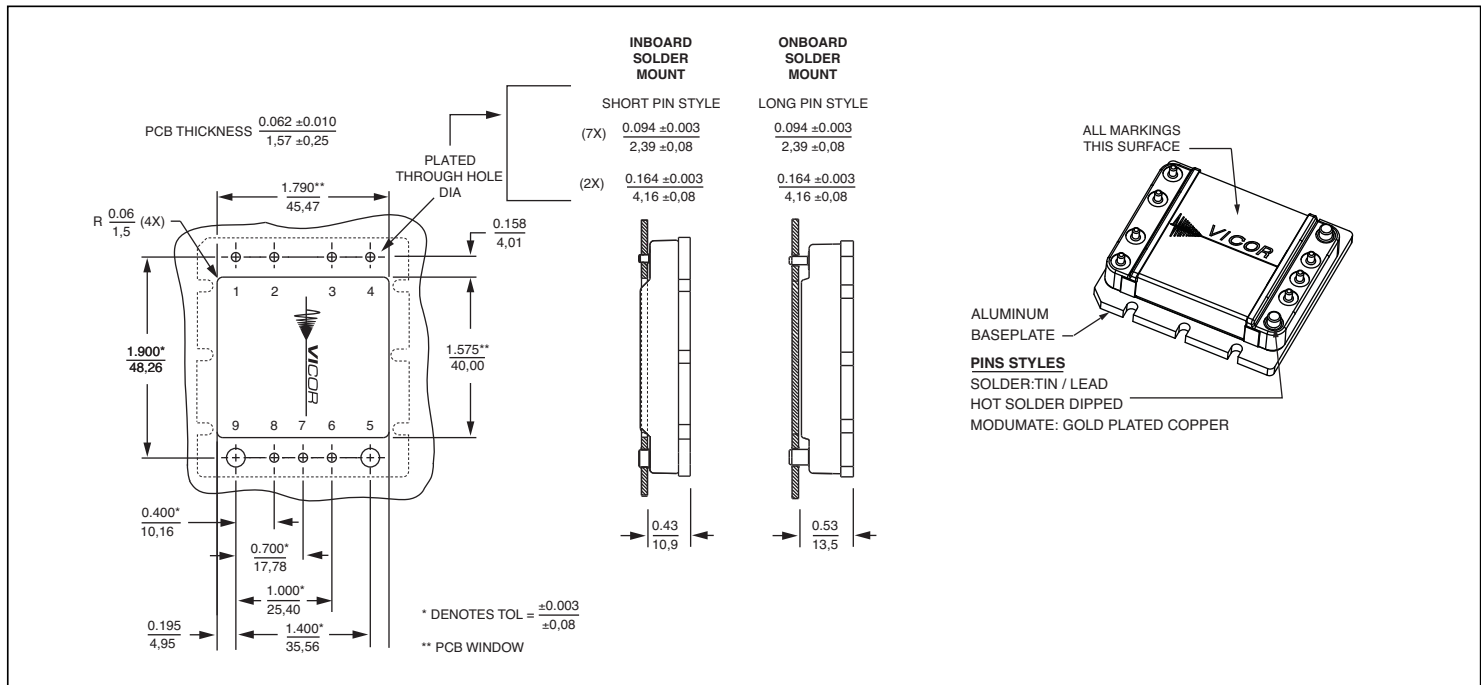
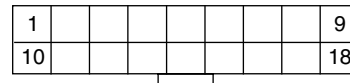
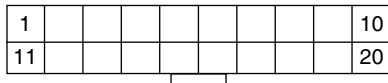
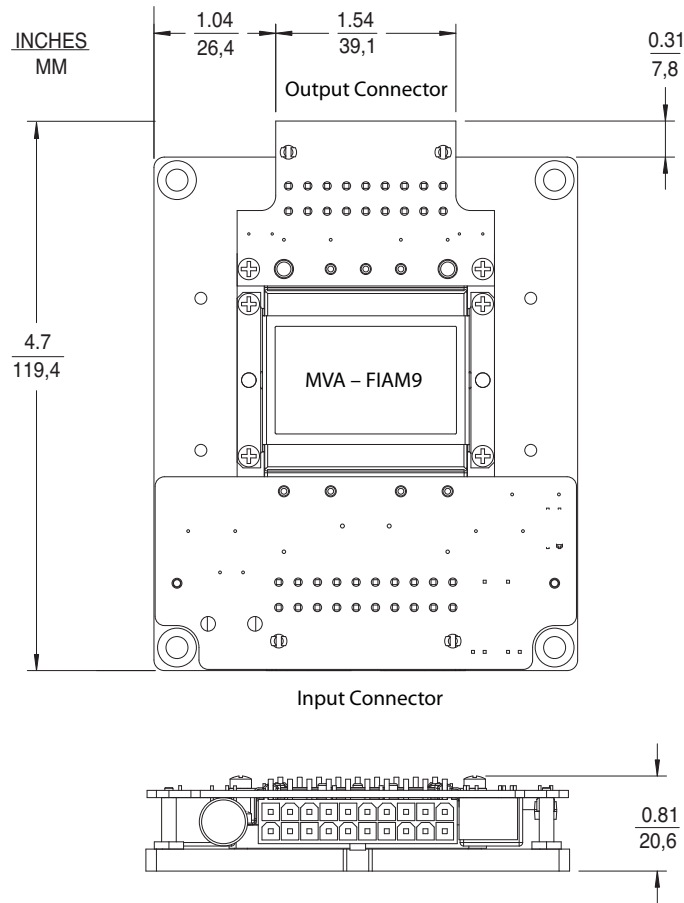

Figure 7 — PCB Mounting Specifications.



Input Connector

Pin #	Function
1 – 4	–Vin
5 – 7	+Vin
8	NC
9	PE protective earth
10	PE protective earth
11 – 13	–Vin
14 – 17	+Vin
18	NC
19	PE protective earth
20	PE protective earth

Output Connector

Pin #	Function	Pin #	Function
1	+Vout	10	+Vout
2	+Vout	11	+Vout
3	+Vout	12	+Vout
4	N/C	13	NC
5	N/C	14	NC
6	N/C	15	On / Off
7	–Vout	16	–Vout
8	–Vout	17	–Vout
9	–Vout	18	–Vout

Input Mounting

Connector	Vicor P/N
Housing	24795
Pin	24796
Kit	24828

Output Mounting

Connector	Vicor P/N
Housing	25050
Pin	24796
Kit	25067

Note: The MVA-FIAM9H and MVA-FIAM9M are delivered with the On / Off control already configured as On using a 0 Ohm resistor on the underside of the output connector board. The MVA-FIAM9H-C and MVA-FIAM9M-C are delivered without the 0 Ohm resistor installed, allowing for user control of the On / Off functionality.

Figure 8 — MVA-FIAM9 Packaging Option

Warranty

Vicor products are guaranteed for two years from date of shipment against defects in material or workmanship when in normal use and service. This warranty does not extend to products subjected to misuse, accident, or improper application or maintenance. Vicor shall not be liable for collateral or consequential damage. This warranty is extended to the original purchaser only.

EXCEPT FOR THE FOREGOING EXPRESS WARRANTY, VICOR MAKES NO WARRANTY, EXPRESS OR IMPLIED, INCLUDING, BUT NOT LIMITED TO, THE WARRANTY OF MERCHANTABILITY OR FITNESS FOR A PARTICULAR PURPOSE.

Vicor will repair or replace defective products in accordance with its own best judgement. For service under this warranty, the buyer must contact Vicor to obtain a Return Material Authorization (RMA) number and shipping instructions. Products returned without prior authorization will be returned to the buyer. The buyer will pay all charges incurred in returning the product to the factory. Vicor will pay all reshipment charges if the product was defective within the terms of this warranty.

Information published by Vicor has been carefully checked and is believed to be accurate; however, no responsibility is assumed for inaccuracies. Vicor reserves the right to make changes to any products without further notice to improve reliability, function, or design. Vicor does not assume any liability arising out of the application or use of any product or circuit; neither does it convey any license under its patent rights nor the rights of others. Vicor general policy does not recommend the use of its components in life support applications wherein a failure or malfunction may directly threaten life or injury. Per Vicor Terms and Conditions of Sale, the user of Vicor components in life support applications assumes all risks of such use and indemnifies Vicor against all damages.

Vicor's comprehensive line of power solutions includes high density AC-DC and DC-DC modules and accessory components, fully configurable AC-DC and DC-DC power supplies, and complete custom power systems.

Information furnished by Vicor is believed to be accurate and reliable. However, no responsibility is assumed by Vicor for its use. Vicor components are not designed to be used in applications, such as life support systems, wherein a failure or malfunction could result in injury or death. All sales are subject to Vicor's Terms and Conditions of Sale, which are available upon request.

Specifications are subject to change without notice.

Intellectual Property Notice

Vicor and its subsidiaries own Intellectual Property (including issued U.S. and Foreign Patents and pending patent applications) relating to the products described in this data sheet. Interested parties should contact Vicor's Intellectual Property Department.

Vicor Corporation
25 Frontage Road
Andover, MA, USA 01810
Tel: 800-735-6200
Fax: 978-475-6715

email

Customer Service: custserv@vicorpower.com
Technical Support: apps@vicorpower.com