



Bulletin 700-SH

- 40 A (resistive) Max. Continuous Load (Output) Current with Heat Sink
- 264V AC or 528V AC Max. Load Voltage Range Options
- 5...24V DC, 100...120V AC, 200...240V AC Control Input Voltage
- LED Indicator for Input/Logic ON/OFF Status Monitoring
- Built-in Varistor to Absorb Most Surges
- Protective Cover for Added Safety (Meets VDE 106 Finger Safe Standard)

Table Of Contents

Product Selection 51
 Accessories 52
 Specifications 53
 Approximate Dimensions 56
 Basic Application Considerations 57





Product Selection

| | Input-to-Output Isolation Method | Zero Cross Function | LED Indicator | Rated Output (Load) Max. Current and Voltage Range ❶ | Rated Input Control Voltage | Cat. No. | Factory-Stocked Item (Single Pack) |
|---------------|----------------------------------|---------------------|---------------|--|-----------------------------|--------------|------------------------------------|
| | Phototriac | Yes | Yes | 5 A @ 24...240V AC | 5...24V DC | 700-SH05GZ25 | ✓ |
| | Photocoupler | | | | 100...120V AC | 700-SH05GA12 | ✓ |
| | | | | | 200...240V AC | 700-SH05GA22 | ✓ |
| | Phototriac | | | 10 A @ 24...240V AC | 5...24V DC | 700-SH10GZ25 | ✓ |
| | Photocoupler | | | | 100...120V AC | 700-SH10GA12 | ✓ |
| | | | | | 200...240V AC | 700-SH10GA22 | ✓ |
| | Phototriac | | | 10 A @ 200...480V AC | 5...24V DC | 700-SH10HZ25 | ✓ |
| | Photocoupler | | | 25 A @ 24...240V AC | 5...24V DC | 700-SH25GZ25 | ✓ |
| | | | | | 100...120V AC | 700-SH25GA12 | ✓ |
| | Photocoupler | | | 200...240V AC | 700-SH25GA22 | ✓ | |
| | Photocoupler | | | 25 A @ 200...480V AC | 5...24V DC | 700-SH25HZ25 | ✓ |
| | Phototriac | | | 40 A @ 24...240V AC | 5...24V DC | 700-SH40GZ25 | ✓ |
| 100...120V AC | | 700-SH40GA12 | ✓ | | | | |
| 200...240V AC | | 700-SH40GA22 | ✓ | | | | |
| Photocoupler | 40 A @ 200...480V AC | 5...24V DC | 700-SH40HZ25 | ✓ | | | |

❶ Maximum load current when mounted on a heat sink

Bulletin 700-SH
Solid-State Relays

Accessories

| | Description | Pkg. Qty | Cat. No. | Factory-Stocked Item |
|---|--|----------|----------|----------------------|
|  <p><i>Cat No. 700-S10</i></p> | Heat Sink— Panel or DIN Rail Mount ❶ | 1 | 700-S10 | ✓ |
|  <p><i>Cat No. 700-S20</i></p> | Heat Sink— Panel or DIN Rail Mount ❶ | 1 | 700-S20 | ✓ |
|  <p><i>Cat No. 700-S30</i></p> | Heat Sink— Panel or DIN Rail Mount ❶ | 1 | 700-S30 | ✓ |
|  <p><i>Cat No. 199-DR1</i></p> | DIN Rail Mounting Pack Standard 35 x 7.5 mm DIN Rail, 1 meter long, 10 rails per package. Order must be for 10 rails or multiples of 10. | 10 | 199-DR1 | ✓ |

❶ For information regarding selection of the proper heat sink for your application, refer to "Heat Sink Size Vs. Load Current" graph on page 54 or "Load Current Vs. Ambient Temperature Characteristics" on page 55.

| Control/Input Ratings | | | | | | | |
|-----------------------|-----------------------|---------------------------------|----------------------|------|-------------------------|------------------|-----------------------------|
| Cat. No. | Rated Control Voltage | Operating Control Voltage Range | Impedance ❶ | | Control Voltage Levels | | |
| 700-SH__G... | 5...24V DC | 4...32V DC | 15 mA max ❷ | | Pick-up Voltage | Drop-out Voltage | |
| | | | | | 4V DC max. | 1V DC min. | |
| | 100...120V AC | 75...132V AC | 36 kΩ +/-20% | | 75V AC max. ❸ | 20V AC min. ❸ | |
| | 200...240V AC | 150...264V AC | 72 kΩ +/-20% | | 150V AC max. ❸ | 40V AC min. ❸ | |
| 700-SH__H... | 5...24V DC | 4...32V DC | 5 mA max. ❷ | | 4V DC max. | 1V DC min. | |
| Load/Output Ratings | | | | | | | |
| Cat. No. | Applicable Load | | | | | | |
| | Rated Load Voltage | Load Voltage Range | Continuous Load | | Current (Resistive) | | Max. Inrush Current❹ |
| | | | With Heat Sink (A) ❺ | | Without Heat Sink (A) ❺ | | |
| | | Min. | Max. | Min. | Max. | | |
| 700-SH05G... | 24...240V AC | 19 ...264V AC | 0.1 A | 5 A | 0.1 A | 3 A | 60 A (@ 50/60 Hz, 1 cycle) |
| 700-SH10G... | | | 0.1 A | 10 A | 0.1 A | 4 A | 150 A (@ 50/60 Hz, 1 cycle) |
| 700-SH10H... | 200...480V AC | 180...528 VAC | 0.2 A | 10 A | 0.2 A | 4 A | |
| 700-SH25G... | 24...240V AC | 19...264V AC | 0.1 A | 25 A | 0.1 A | 4 A | 440 A (@ 50/60 Hz, 1 cycle) |
| 700-SH25H... | 200...480V AC | 180...528V AC | 0.2 A | 25 A | 0.2 A | 4 A | |
| 700-SH40G... | 24...240V AC | 19...264V AC | 0.1 A | 40 A | 0.1 A | 6 A | 440 A (@ 50/60 Hz, 1 cycle) |
| 700-SH40H... | 200...480V AC | 180...528V AC | 0.2 A | 40 A | 0.2 A | 6 A | |

- ❶ The input impedance is measured at the maximum value of the rated supply voltage.
- ❷ With a constant current input system, SSR impedance varies with a change in input voltage.
- ❸ Refer to graphs, "Temperature Characteristics..." and "Must Release Voltage" on page 54 for further details.
- ❹ When specified heat sink is used. Refer to accessories, page 52 for applicable heat sinks. For more details, refer to graphs "Load Current Vs. Ambient Temperature Characteristics" on page 55, and the "Heat Sink vs. Load Current" graph on page 54.
- ❺ If the SSR operation is continuous ON/OFF, this value should be reduced by 50%. Refer to "Inrush Current Resistivity" graphs on page 54 for more details.

| Characteristics | | | |
|----------------------------------|--|-------------|--------------------------|
| Cat. No. | 700-SH05G, -SH10G, SH25G | 700-SH40G | 700-SH10H, -SH25H, SH40H |
| Load Switching Method/ Device | Triac | | Thyristor |
| Pick-up Time | 1/2 of load power source + 1 ms max. (DC input) 3/2 of load power source + 1 ms max. (AC input) | | |
| Drop-out Time | 1/2 of load power source + 1 ms max. (DC input) 3/2 of load power source + 1 ms max. (AC input) | | |
| Output ON Voltage Drop | 1.6 V (RMS) max | | 1.8 V (RMS) max |
| Output Leakage Current | 5 mA max (at 100V AC) | | 10 mA max. (@ 200V AC) |
| | | | 20 mA max. (@ 400V AC) |
| Output V_{DRM} , V_{CEO} (V) | 600 | 600 | 1200 |
| Output di/dt (A/uS) | -SH05G = 100, -SH010G, -SH25G= 50 | 50 | 100 |
| Output dv/dt (V/uS) | -SH05G = 200, -SH010G, -SH25G= 100 | 100 | 300 |
| Output I^2t (A ² S) | -SH05G = 24.5, -SH010G=112.5 -SH25G= 260 | 1260 | 260, SH40 = 1800 |
| Output Tj °C Max. | 125 | | |
| Insulation Resistance | 100 MΩ min (at 500 VDC) | | |
| Dielectric Strength | 2,500V AC, 50/60 Hz for 1 minute | | |
| Vibration Resistance (max.) | 10...55 Hz, 1.5 mm double amplitude (10 G) | | |
| Shock Resistance (max.) | 1,000 m/s ² (100 G) | | |
| Ambient Temperature | Operating: -30°C...80°C (-22°F...176°F) with no icing or condensation | | |
| | Storage: -30°C...100°C (-22°F...212°F) with no icing or condensation | | |
| Ambient Humidity | Operating: 45%...85% (no condensation) | | |
| Standards ① | UL508, CSA C22.2, CE, TÜV | | |
| Weight | Approx. 60g | Approx. 70g | Approx. 80g |

① Cat. No. 700-SH__HZ25 not CE or TÜV approved.

Inrush Current Resistivity ②

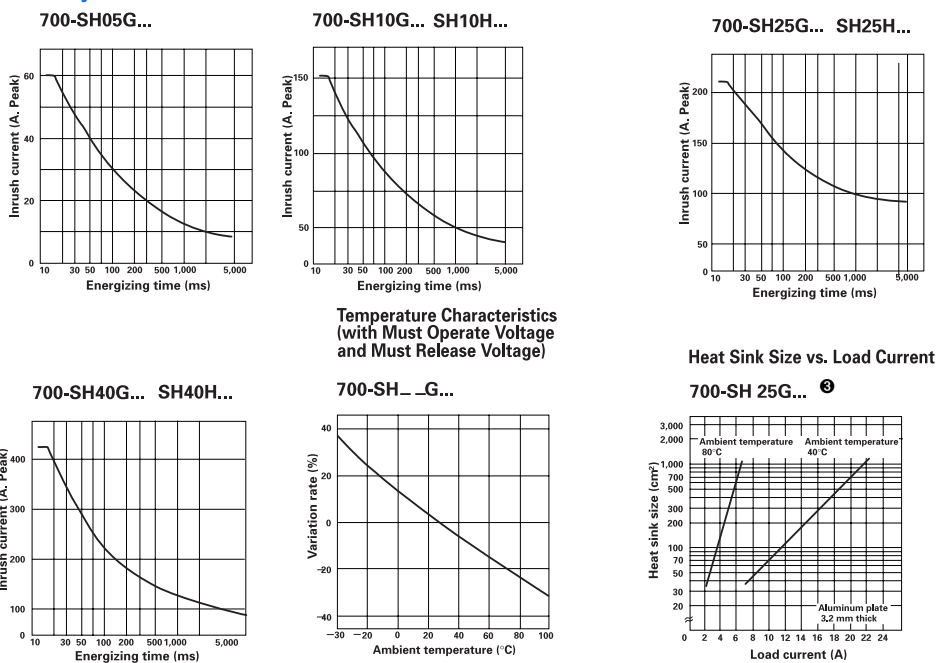

- ② Inrush current resistivity is the ability of an SSR to withstand a large surge current for a short period of time. Surges are considered non-repetitive (max. repeatability once every 2...5 seconds). Keep the inrush current to half the rated value if it occurs repetitively. Exceeding the non-repetitive inrush current will damage the SSR.
- ③ The heat sink size refers to the combined area of the sides of the heat sink that radiate heat. For example, when a current of 18 A is allowed to flow through the SSR at 40°C, the graph shows that the heat sink size is about 450 cm². Therefore, if the heat sink is square, one side of the heat sink must be 15 cm (15² x 2 = 450) or longer.

Load Current vs. Ambient Temperature Characteristics

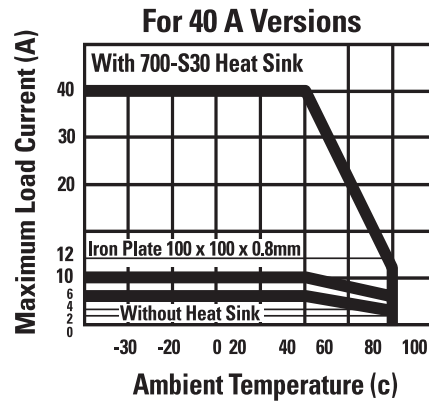
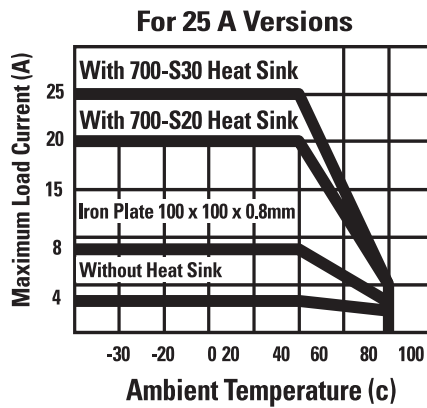
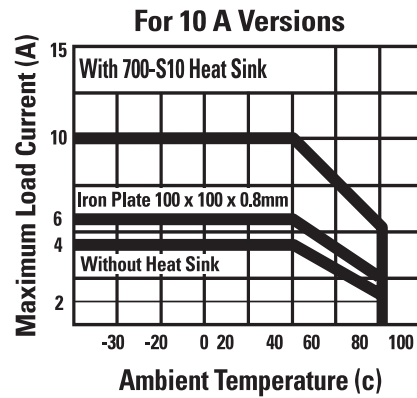
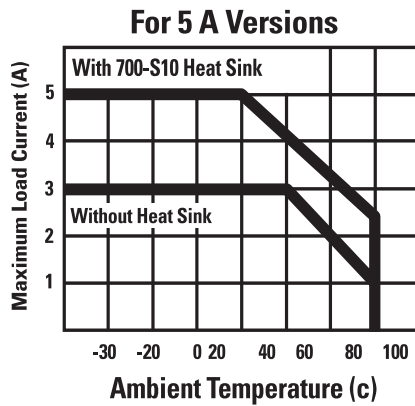

- ❶ For the above 5 graphs, the line "with iron plate measuring 100 x 100 x 0.8" means the SSR is mounted directly to an iron plate of at least this size.
- ❷ All graphs assume conductive grease is being used. Refer to page 56 for details of using conductive grease.

Bulletin 700-SH Solid-State Relays

Approximate Dimensions

Mounting Considerations ①②③④⑤

All units are in millimeters unless otherwise indicated. Dimensions are not intended for manufacturing purposes.

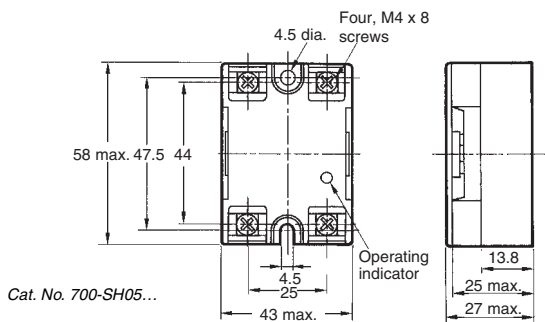

Mounting Holes

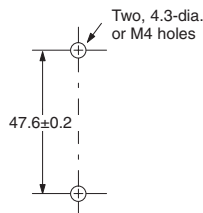

Terminal Arrangement/ Internal Connections (Top View)

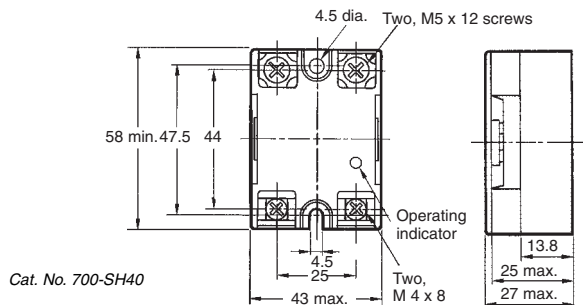
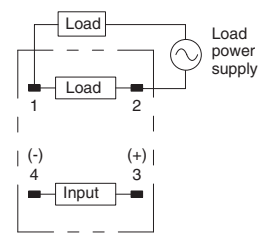

Mounting Holes

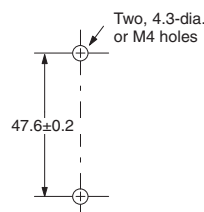

- ① The proper mounting orientation of the heat sink is so the heat fins run perpendicular to the floor (vertical) to maximize ventilation flow.
- ② If the fins do not run perpendicular to the floor, a 30% current derating is required.
- ③ When attaching a heat sink to Bulletin 700-SH, apply heat conductive grease on the heat sink to maximize heat transfer between the SSR and the heat sink. Recommended types: Silicon based, Toshiba YG6240; Non-silicon based, AOS company type 53300.
- ④ Tighten the SSR panel/heat sink mounting screws to a torque of 0.78...0.98 Nm (6.9...8.7 lb-in).
- ⑤ Tighten the SSR terminal wiring screws as follows M4: 0.98...1.37 Nm (8.67...12.12 lb-in.), M5: 1.57...2.35 Nm (13.89...20.8 lb-in.)

Heat Sinks ⑥ ⑦

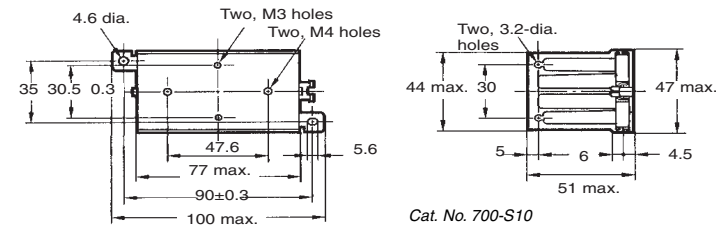

Mounting Holes

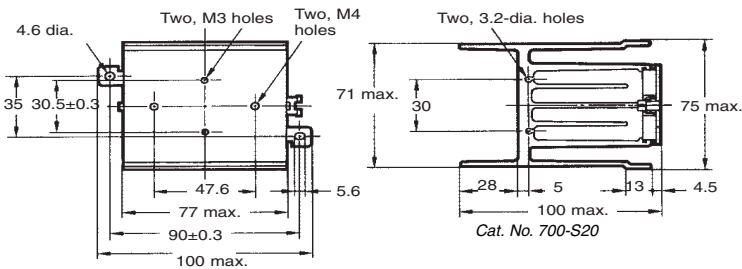
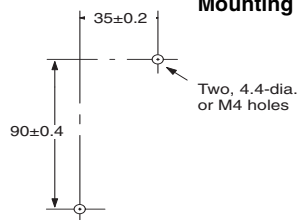

Mounting Holes

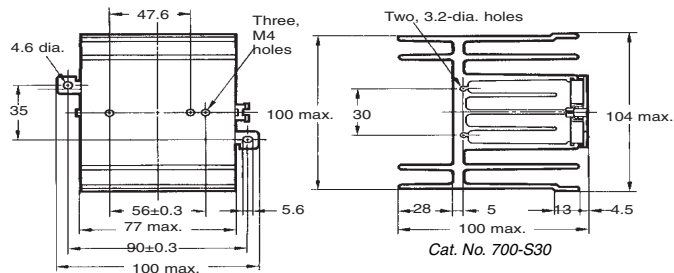
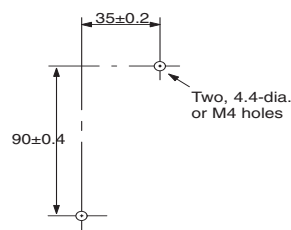

Mounting Holes

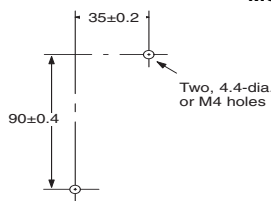

- ⑥ Tighten the heat sink mounting screws (M4) to a torque of 0.98...1.37 Nm (8.67...12.12 lb-in).
- ⑦ Heat sink weight: cat. nos. 700-S10 = 200 g, 700-S20 = 400 g, 700-S30 = 560 g

Load Connection

- For an AC load, use a power supply rated at 50 or 60 Hz. The maximum operating frequency is 10 Hz.
- The Bulletin 700-SH has a built-in varistor for surge/inrush protection of AC loads. If additional suppression is required, connect an external varistor across the load device terminals. Select a varistor which meets the load voltage condition outlined in the table below.

| Load Voltage | Varistor Voltage | Varistor Surge Resistance |
|---------------|------------------|---------------------------|
| 100...120V AC | 240...270 V | 1000 A min. |
| 200...240V AC | 440...470V | |
| 380...480V AC | 820...1000V | |

Zero Cross Function

A SSR with a zero cross function operates when an AC load voltage reaches the zero point or its vicinity. This reduces clicking noises when the load is switched, and minimizes the influence of an inductive load, such as a lamp, heater, or motor, on the power supply because the inrush current of the load is reduced. This can also minimize the scale of the inrush current protection circuit.

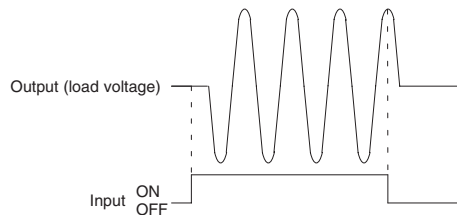

At a low applied voltage, such as 24V AC, the load current is not fully supplied. When the unit is switched ON, the voltage required to power the unit deprives the output signal of the necessary voltage level and thus creates loss time. The lower the load voltage is, the greater the loss time is. This condition, however, will not create any serious problems.

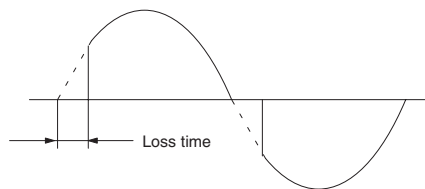

For a DC inductive load, a diode should be connected parallel to the load to absorb the counter electromotive force (OFF) of the load.

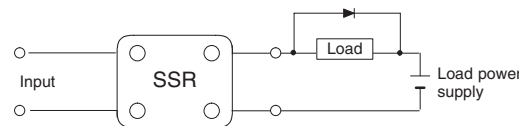

Note: For additional details when using Solid-State Relays, refer to pub. 700-AT001A--EN-E, "Solid-State Relay Application Guide" available at www.theautomationbookstore.com.