

FSL137H

Green Mode Fairchild Power Switch (FPS™)

Features

- Built-in 5ms Soft-Start Function
- Internal Avalanche Rugged 700V SenseFET
- Low Audio Noise
- High-Voltage Startup
- Fixed PWM Frequency at 100KHz
- Linearly Decreasing PWM Frequency to 18KHz
- Peak-Current-Mode Control
- Cycle-by-Cycle Current Limiting
- Leading-Edge Blanking (LEB)
- Synchronized Slope Compensation
- GATE Output Maximum Voltage Clamp (18V)
- Internal Open-loop Protection (OLP)
- V_{DD} Under-Voltage Lockout (UVLO)
- V_{DD} Over-Voltage Protection (OVP)
- Constant Power Limit (Full AC Input Range)
- Internal OTP Sensor with Hysteresis

Applications

General-purpose switch-mode power supplies and flyback power converters, including:

- SMPS for VCR, SVR, STB, DVD & DVCD Player, Printer, Facsimile, & Scanner
- Adapter for Camcorder

Description

The highly integrated FSL137H consists of an integrated current mode Pulse Width Modulator (PWM) and an avalanche-rugged 700V SenseFET. It is specifically designed for high-performance offline Switch Mode Power Supplies (SMPS) with minimal external components.

The integrated PWM controller features include a proprietary green-mode function that provides off-time modulation to linearly decrease the switching frequency at light-load conditions to minimize standby power consumption. To avoid acoustic noise problems, the minimum PWM frequency is set above 18KHz. The green-mode function enables the power supply to meet international power conservation requirements. With the internal high-voltage startup circuitry, the power loss due to bleeding resistors is also eliminated. To further reduce power consumption, the PWM controller is manufactured using the BiCMOS process, which allows an operating current of only 3.5mA.

The FSL137H built-in synchronized slope compensation achieves stable peak-current-mode control. The proprietary external line compensation ensures constant output power limit over a wide AC input voltage range, from 90V_{AC} to 264V_{AC}.

The FSL137H provides many protection functions. In addition to cycle-by-cycle current limiting, the internal open-loop protection circuit ensures safety when an open-loop or output short-circuit failure occurs. PWM output is disabled until V_{DD} drops below the UVLO lower limit, when the controller starts up again. As long as V_{DD} exceeds ~28V, the internal OVP circuit is triggered.

Compared to a discrete MOSFET and controller or RCC switching converter solution, the FSL137H reduces total component count, design size, and weight while increasing efficiency, productivity, and system reliability. These devices provide a basic platform well suited for design of cost-effective flyback converters.

Ordering Information

Part Number	SenseFET	Operating Temperature Range	 Eco Status	Package	Packing Method
FSL137HNY	3.0A 700V	-40°C to +105°C	Green	8-Pin Dual In-Line Package (DIP)	Tube

 For Fairchild's definition of Eco Status, please visit: http://www.fairchildsemi.com/company/green/rohs_green.html

Application Diagram

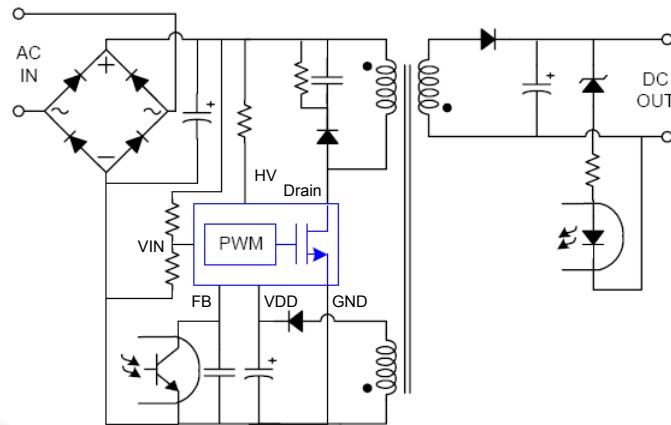

Figure 1. Typical Flyback Application

Output Power Table⁽¹⁾

Product	230V _{AC} ± 15% ⁽²⁾		85-265V _{AC}	
	Adapter ⁽³⁾	Open Frame ⁽⁴⁾	Adapter ⁽³⁾	Open Frame ⁽⁴⁾
FSL137H	17.5W	25W	13W	19W

Notes:

1. The maximum output power can be limited by junction temperature.
2. 230 V_{AC} or 100/115 V_{AC} with doublers.
3. Typical continuous power in a non-ventilated enclosed adapter with sufficient drain pattern as a heat sink, at T_A=50°C ambient.
4. Maximum practical continuous power in an open-frame design with sufficient drain pattern as a heat sink, at T_A=50°C ambient.

Internal Block Diagram

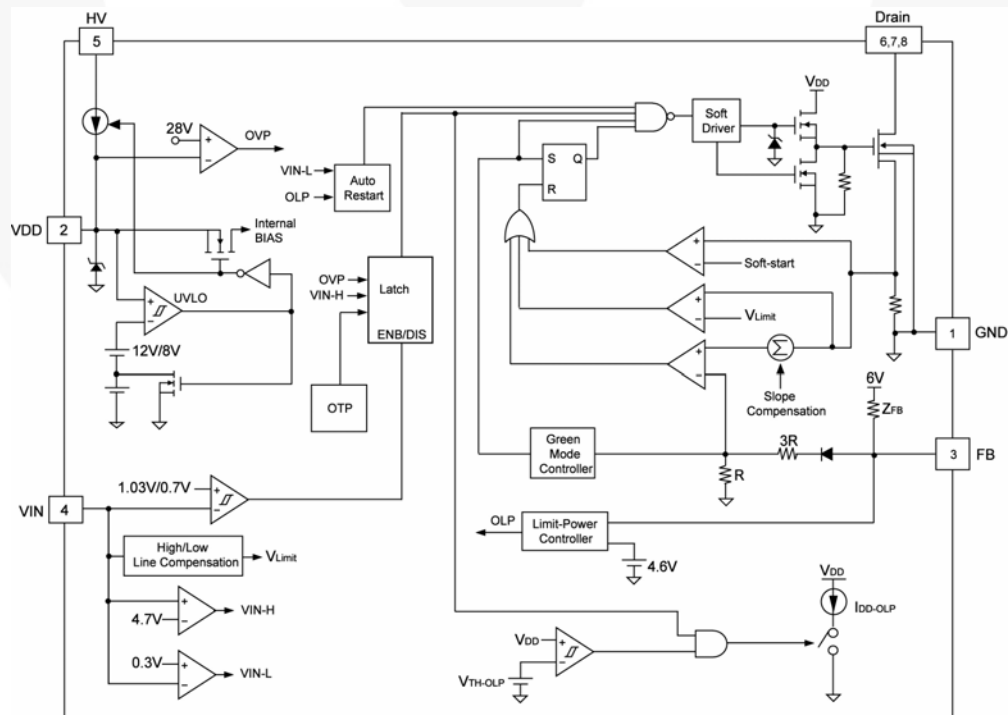
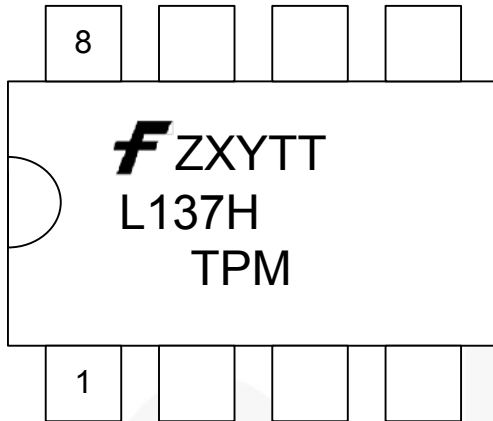

Figure 2. Internal Block Diagram

Pin Configuration



F – Fairchild logo
Z – Plant code
X – 1-digit year code
Y – 1-digit week code
TT – 2-digit die run code
T – Package type (N:DIP)
P – Y: Green package
M – Manufacture flow code

Figure 3. Pin Configuration

Pin Definitions

Pin #	Name	Description
1	GND	Ground. SenseFET source terminal on primary side and internal controller ground.
2	VDD	Power Supply. The internal protection circuit disables PWM output as long as V_{DD} exceeds the OVP trigger point.
3	FB	Feedback. The signal from the external compensation circuit is fed into this pin. The PWM duty cycle is determined in response to the signal on this pin and the internal current-sense signal.
4	VIN	Line-Voltage Detection. The line-voltage detection is used for brownout protection with hysteresis and constant output power limit over universal AC input range. This pin has additional protections that are pull-HIGH latch and pull-low auto recovery, depending on the application.
5	HV	Startup. For startup, this pin is pulled HIGH to the line input or bulk capacitor via resistors.
6	Drain	SenseFET Drain. High-voltage power SenseFET drain connection.
7	Drain	SenseFET Drain. High-voltage power SenseFET drain connection.
8	Drain	SenseFET Drain. High-voltage power SenseFET drain connection.

Absolute Maximum Ratings

Stresses exceeding the absolute maximum ratings may damage the device. The device may not function or be operable above the recommended operating conditions and stressing the parts to these levels is not recommended. In addition, extended exposure to stresses above the recommended operating conditions may affect device reliability. The absolute maximum ratings are stress ratings only.

Symbol	Parameter	Min.	Max.	Units
V _{DRAIN}	Drain Pin Voltage ^(5, 6)		700	V
I _{DM}	Drain Current Pulsed ⁽⁷⁾		12	A
E _{AS}	Single Pulsed Avalanche Energy ⁽⁸⁾		230	mJ
V _{VDD}	DC Supply Voltage		30	V
V _{FB}	FB Pin Input Voltage	-0.3	7.0	V
V _{VIN}	VIN Pin Input Voltage	-0.3	7.0	V
V _{HV}	HV Pin Input Voltage		700	V
P _D	Power Dissipation (T _A < 50°C)		1.5	W
θ _{JA}	Junction-to-Air Thermal Resistance		80	°C/W
θ _{JC}	Junction-to-Case Thermal Resistance		20	°C/W
T _J	Operating Junction Temperature	Internally Limited		°C
T _{STG}	Storage Temperature Range	-55	+150	°C
T _L	Lead Temperature (Wave Soldering or IR, 10 Seconds)		+260	°C
ESD	Electrostatic Discharge Capability, All Pins Except HV Pin	Human Body Model: JESD22-A114	4	kV
		Charged Device Model: JESD22-C101	1	

Notes:

- All voltage values, except differential voltages, are given with respect to the network ground terminal.
- Stresses beyond those listed under Absolute Maximum Ratings may cause permanent damage to the device.
- Non-repetitive rating: Pulse width is limited by maximum junction temperature.
- L = 51mH, starting T_J = 25°C.

Recommended Operating Conditions

The Recommended Operating Conditions table defines the conditions for actual device operation. Recommended operating conditions are specified to ensure optimal performance to the datasheet specifications. Fairchild does not recommend exceeding them or designing to Absolute Maximum Ratings.

Symbol	Parameter	Conditions	Min.	Typ.	Max.	Unit
T _A	Operating Ambient Temperature		-40		+105	°C

Electrical Characteristics

$V_{DD}=15V$, $T_A=25^\circ C$ unless otherwise specified.

Symbol	Parameter	Conditions	Min.	Typ.	Max.	Unit
SenseFET Section⁽⁹⁾						
BV_{DSS}	Drain- Source Breakdown Voltage	$V_{DS} = 700V$, $V_{GS} = 0V$	700			V
I_{DSS}	Zero-Gate-Voltage Drain Current	$V_{DS} = 700V$, $V_{GS} = 0V$		0.5	50.0	μA
		$V_{DS} = 560V$, $V_{GS} = 0V$, $T_A = 125^\circ C$		1	200	
$R_{DS(ON)}$	Drain-Source On-State Resistance ⁽¹⁰⁾	$V_{GS} = 10V$, $I_D = 0.5A$		4.00	4.75	Ω
C_{ISS}	Input Capacitance	$V_{GS} = 0V$, $V_{DS} = 25V$, $f = 1MHz$		315	410	pF
C_{OSS}	Output Capacitance	$V_{GS} = 0V$, $V_{DS} = 25V$, $f = 1MHz$		47	61	pF
C_{RSS}	Reverse Transfer Capacitance	$V_{GS} = 0V$, $V_{DS} = 25V$, $f = 1MHz$		9	14	pF
$t_{d(on)}$	Turn-On Delay Time	$V_{DS} = 350V$, $I_D = 1.0A$		11.2	33.0	ns
t_r	Rise Time	$V_{DS} = 350V$, $I_D = 1.0A$		34	78	ns
$t_{d(off)}$	Turn-Off Delay Time	$V_{DS} = 350V$, $I_D = 1.0A$		28.2	67.0	ns
t_f	Fall Time	$V_{DS} = 350V$, $I_D = 1.0A$		32	74	ns
Control Section						
V_{DD} Section						
V_{OP}	Continuously Operating Voltage				22	V
V_{DD-ON}	Start Threshold Voltage		11	12	13	V
V_{DD-OFF}	Minimum Operating Voltage		7	8	9	V
I_{DD-ST}	Startup Current	$V_{DD-ON} - 0.16V$			30	μA
I_{DD-OP}	Operating Supply Current	$V_{DD}=15V$, $V_{FB}=3V$	3.0	3.5	4.0	mA
I_{DD-BM}	Green-Mode Operating Supply Current	$V_{FB}=V_{FB-G}$		2.5		mA
I_{DD-OLP}	Internal Sink Current	$V_{TH-OLP}+0.1V$	30	60	90	μA
V_{TH-OLP}	I_{DD-OLP} Off Voltage		5	6	7	V
V_{DD-OVP}	V_{DD} Over-Voltage Protection		27	28	29	V
$t_{D-VDDOVP}$	V_{DD} Over-Voltage Protection Debounce Time		75	130	200	μs
HV Section						
I_{HV}	Maximum Current Drawn from HV Pin	HV 120V _{DC} , $V_{DD}=0V$ with 10 μF	1.5	3.5	5.0	mA
I_{HV-LC}	Leakage Current After Startup	HV=700V, $V_{DD}=V_{DD-OFF}+1V$		1	20	μA
Oscillator Section						
f_{OSC}	Frequency in Nominal Mode	Center Frequency	94	100	106	kHz
f_{OSC-G}	Green-Mode Frequency		14	18	22	kHz
D_{MAX}	Maximum Duty Cycle			85		%
f_{DV}	Frequency Variation vs. V_{DD} Deviation	$V_{DD}=11V$ to 22V			5	%
f_{DT}	Frequency Variation vs. Temperature Deviation ⁽⁹⁾	$T_A = -40$ to $+105^\circ C$			5	%

Continued on the following page...

Electrical Characteristics (Continued)

V_{DD}=15V, T_A=25°C unless otherwise specified.

Symbol	Parameter	Conditions	Min.	Typ.	Max.	Unit
V_{IN} Section						
V _{IN-ON}	PWM Turn-on Threshold Voltage		0.98	1.03	1.08	V
V _{IN-RL}	Release Latch Voltage		0.65	0.70	0.75	V
V _{IN-H}	Pull HIGH Latch Trigger Level		4.4	4.7	5.0	V
t _{IN-H}	Pull HIGH Latch Debounce Time			100		μs
V _{IN-L}	Pull LOW Auto Recovery Trigger Level		0.2	0.3	0.4	V
Feedback Input Section						
A _V	FB Voltage to Current-Sense Attenuation			1/4.0		V/V
Z _{FB}	Input Impedance			9		kΩ
V _{FB-OPEN}	Output High Voltage		5			V
V _{FB-OLP}	FB Open-Loop Trigger Level		4.4	4.6	4.8	V
t _{D-OLP}	Delay Time of FB Pin Open-loop Protection		50	56	59	ms
V _{FB-N}	Green-Mode Entry FB Voltage		2.3	2.5	2.7	V
V _{FB-G}	Green-Mode Ending FB Voltage			V _{FB-N} - 0.1		V
V _{FB-ZDC}	Zero Duty Cycle FB Voltage		1.9	2.1	2.3	V

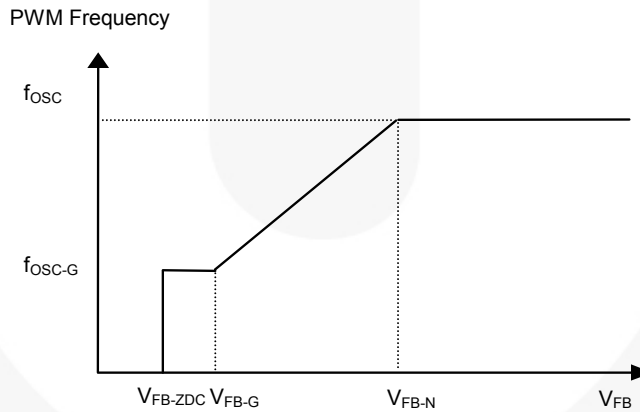

Figure 4. V_{FB} vs. PWM Frequency

Symbol	Parameter	Conditions	Min.	Typ.	Max.	Unit
Current-Sense Section						
I _{LIM} at V _{IN} =1.2V	Peak Current Limit	V _{IN} =1.2V		0.8		A
I _{LIM} at V _{IN} =3.6V	Peak Current Limit	V _{IN} =3.6V		0.65		A
t _{SS}	Period during Soft Startup Time ⁽⁹⁾		4.5	5.0	5.5	ms
Over-Temperature Protection Section (OTP)						
T _{OTP}	Protection Junction Temperature ^(9, 11)			142		°C

Notes:

9. These parameters, although guaranteed, are not 100% tested in production.
10. Pulse test: pulse width ≤ 300μs, duty ≤ 2%.
11. When activated, the output is disabled and the latch is turned off.
12. These parameters, although guaranteed, are tested in wafer process.

Typical Characteristics

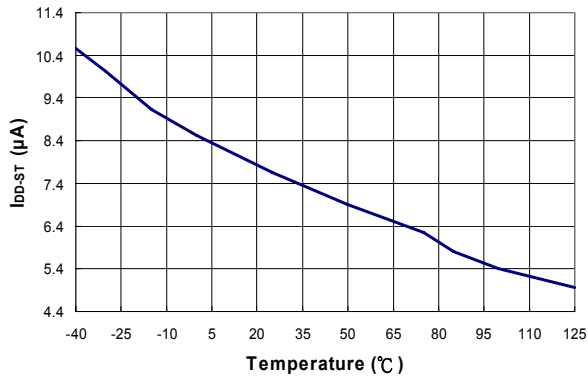

Figure 5. I_{DD-ST} vs. Temperature

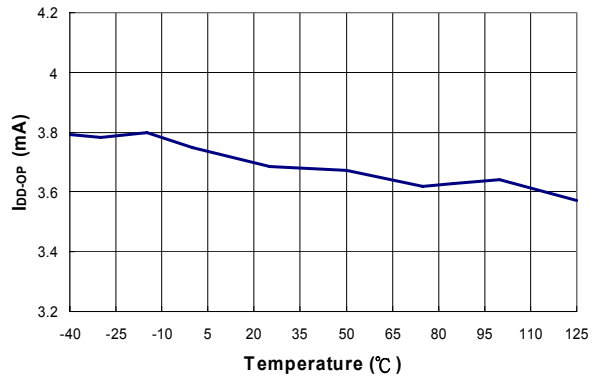

Figure 6. I_{DD-OP} vs. Temperature

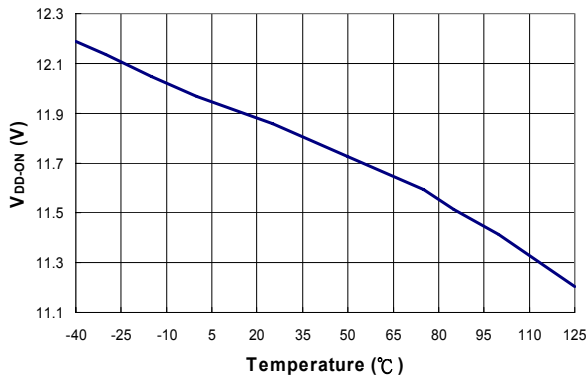

Figure 7. V_{DD-ON} vs. Temperature

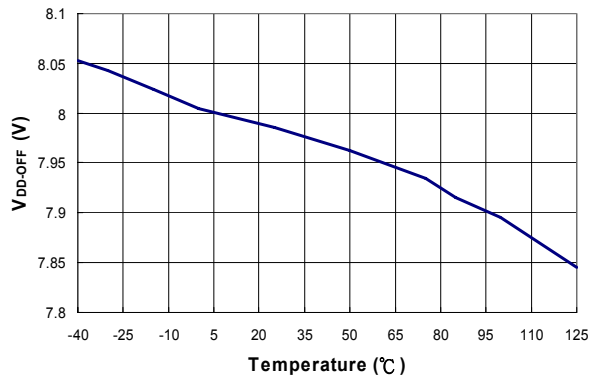

Figure 8. V_{DD-OFF} vs. Temperature

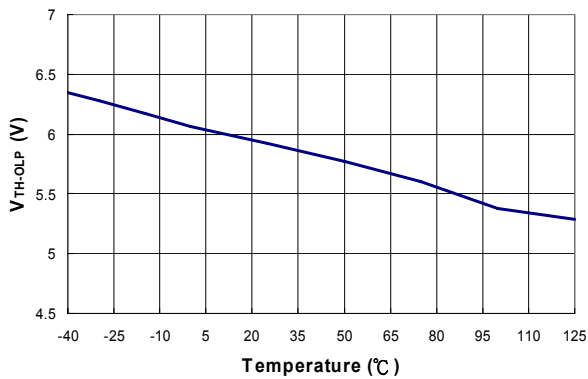

Figure 9. V_{TH-OLP} vs. Temperature

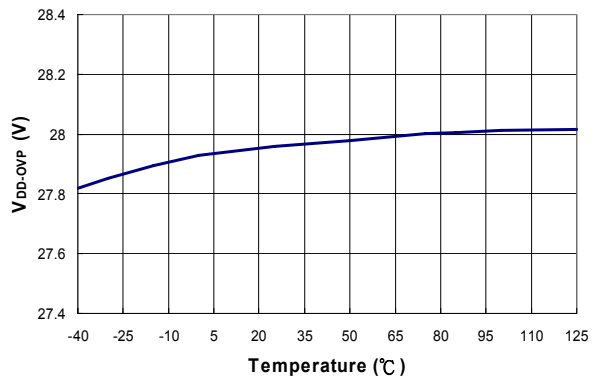

Figure 10. V_{DD-OVP} vs. Temperature

Typical Characteristics

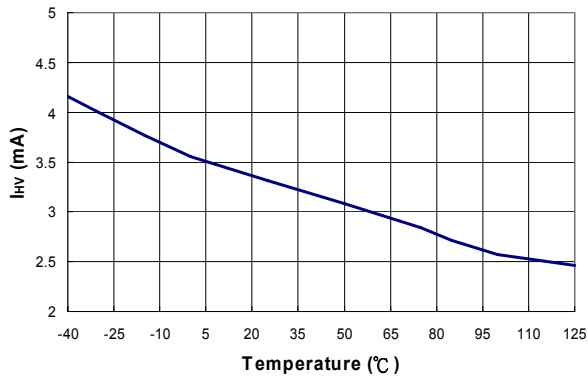

Figure 11. I_{HV} vs. Temperature

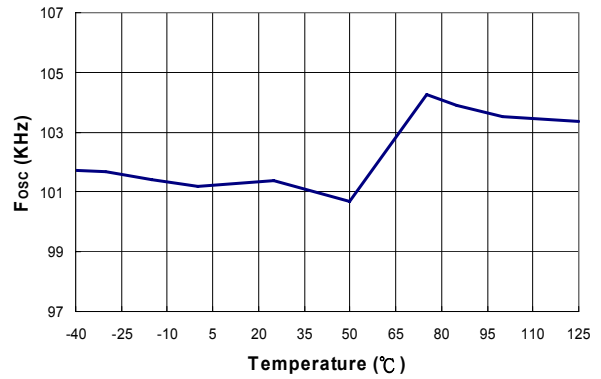

Figure 12. f_{osc} vs. Temperature

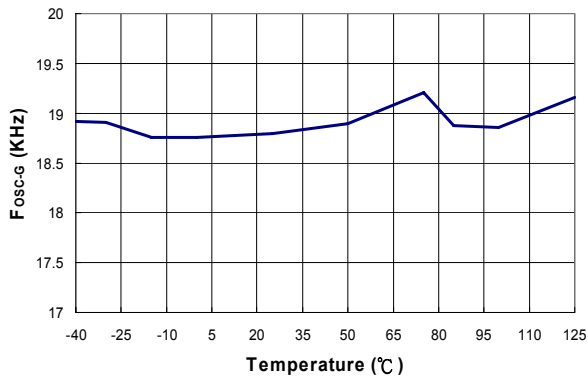

Figure 13. f_{osc-G} vs. Temperature

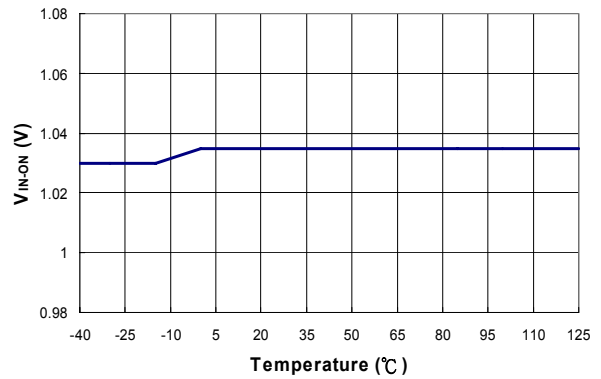

Figure 14. V_{IN-ON} vs. Temperature

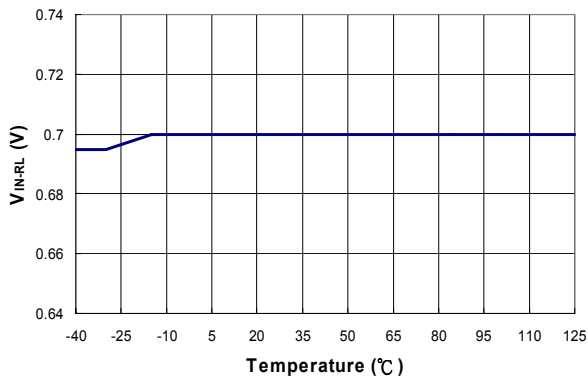

Figure 15. V_{IN-RL} vs. Temperature

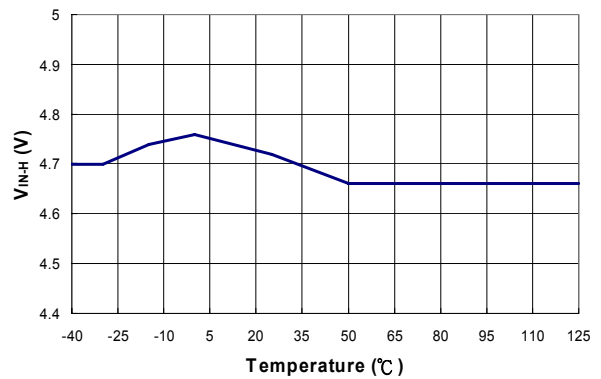

Figure 16. V_{IN-H} vs. Temperature

Typical Characteristics

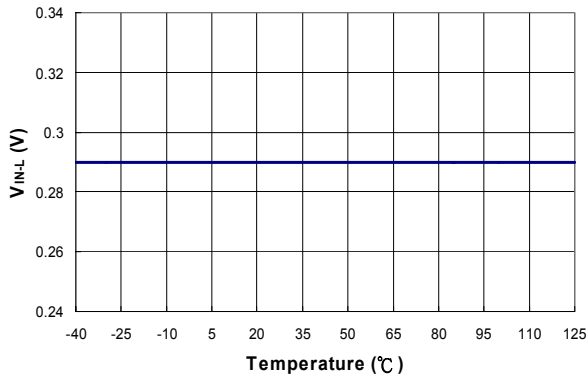

Figure 17. V_{IN-L} vs. Temperature

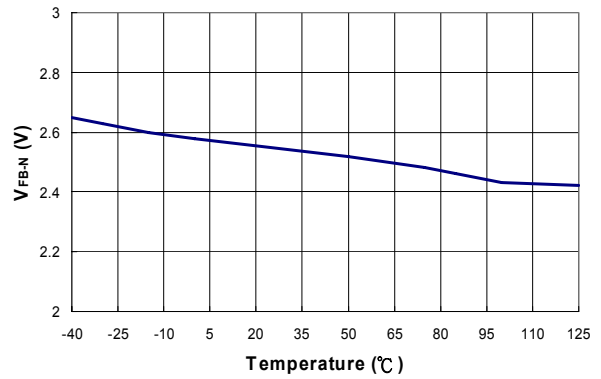

Figure 18. V_{FB-N} vs. Temperature

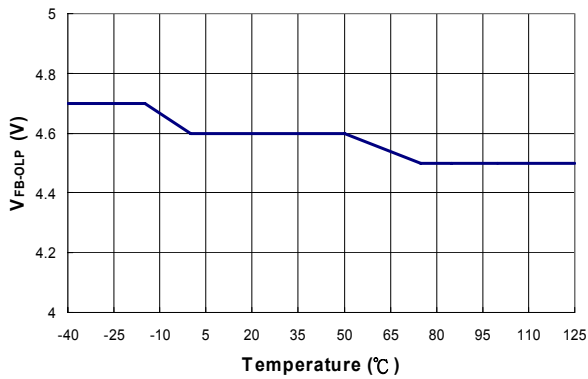

Figure 19. V_{FB-OLP} vs. Temperature

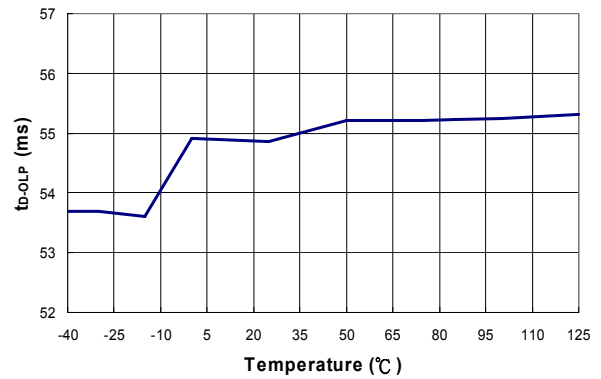

Figure 20. t_{D-OLP} vs. Temperature

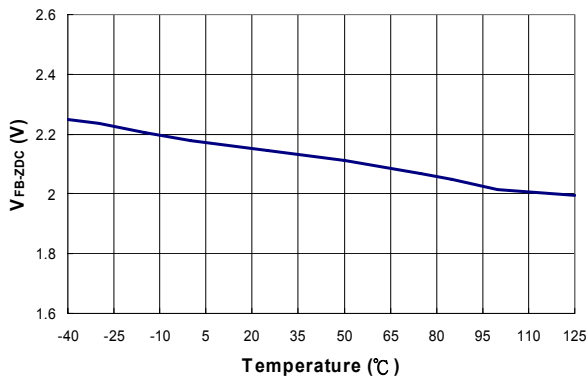

Figure 21. V_{FB-ZDC} vs. Temperature

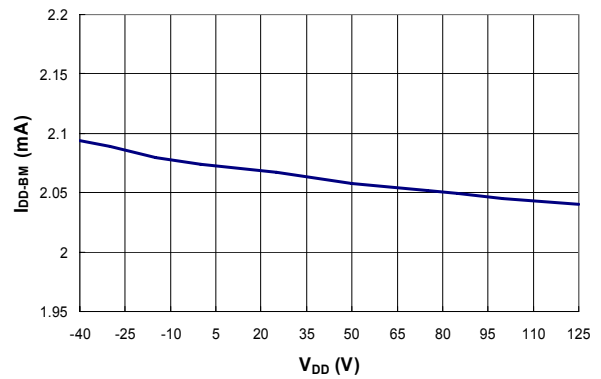

Figure 22. I_{DD-BM} vs. Temperature

Functional Description

Startup Operation

For startup, the HV pin is connected to the line input or bulk capacitor through the external resistor, R_{HV} , as shown in Figure 23. Typical startup current drawn from the HV pin is 3.5mA and it charges the V_{DD} capacitor through the resistor R_{HV} . The startup current turns off when the V_{DD} capacitor voltage reaches V_{DD-ON} . The V_{DD} capacitor maintains V_{DD} until the auxiliary winding of the transformer provides the operating current.

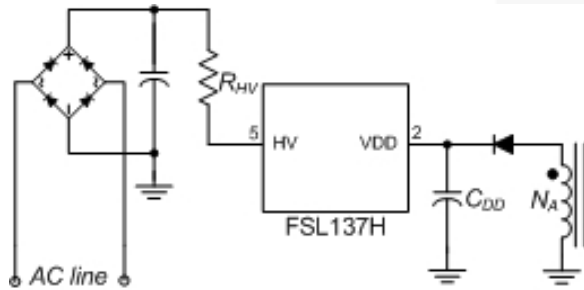

Figure 23.Startup Circuit

Slope Compensation

FSL137H is designed for flyback power converters. The peak-current mode control is used to optimize system performance. Slope compensation is added to stabilize the current loop. FSL137H inserts a synchronized, positively sloped ramp at each switching cycle.

Soft Start

The FSL137H has internal soft-start circuit that slowly increases the SenseFET current after startup. The typical soft-start time is 5ms during which the V_{Limit} level is increased in six steps to smoothly establish the required output voltage, as shown in Figure 24. It also helps to prevent transformer saturation and reduce the stress on the secondary diode during startup.

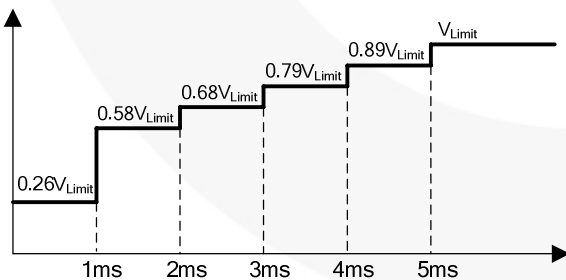

Figure 24.Soft-Start Function

Green-Mode Operation

The FSL137H uses feedback voltage (V_{FB}) as an indicator of the output load and modulates the PWM frequency, as shown in Figure 25, such that the switching frequency decreases as load decreases. In heavy load conditions, the switching frequency is 100kHz. Once V_{FB} decreases below V_{FB-N} (2.5V), the PWM frequency starts to linearly decrease from 100kHz to 18kHz to reduce the switching losses. As V_{FB} decreases below V_{FB-G} (2.4V), the switching frequency is fixed at 18kHz and FSL137H enters into “deep” green mode to reduce the standby power consumption. As V_{FB} decreases below V_{FB-ZDC} (2.1V), FSL137H enters into burst-mode operation. When V_{FB} drops below V_{FB-ZDC} , FSL137H stops switching and the output voltage starts to drop, which causes the feedback voltage to rise. Once V_{FB} rises above V_{FB-ZDC} , switching resumes. Burst mode alternately enables and disables switching, thereby reducing switching loss to improve power saving, as shown in Figure 26.

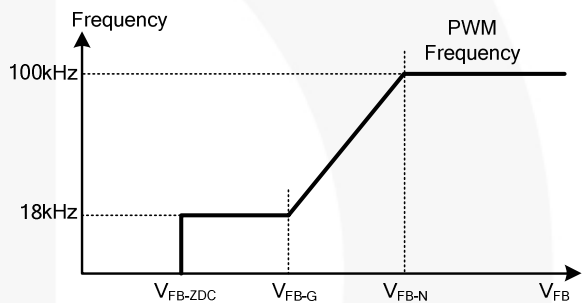

Figure 25. PWM Frequency

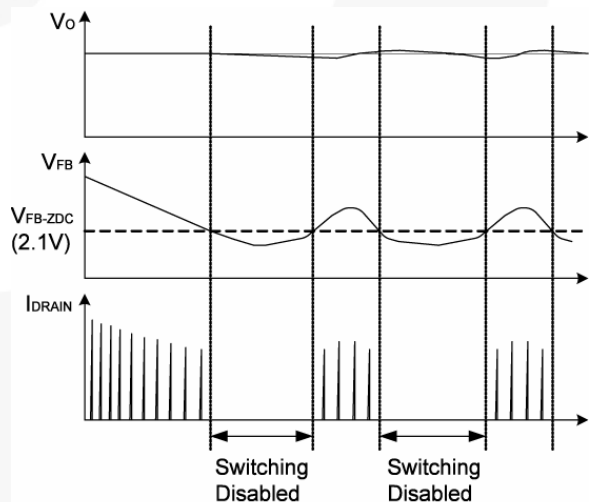

Figure 26.Burst Mode Operation

Constant Power Control

To limit the output power of the converter constantly, high/low line compensation is included. Sensing the converter input voltage through the VIN pin, the high/low line compensation function generates a relative peak-current-limit threshold voltage for constant power control, as shown in Figure 27.

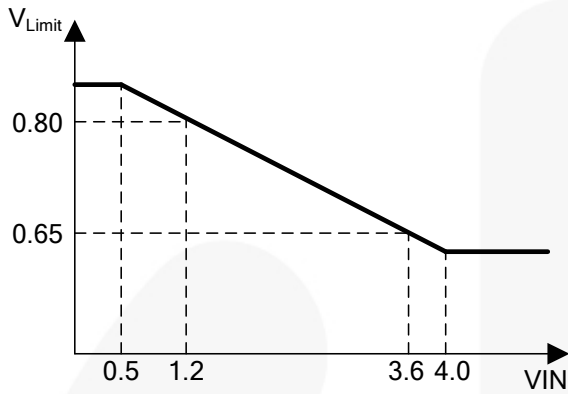

Figure 27. Constant Power Control

Protections

The FSL137H provides full protection functions to prevent the power supply and the load from being damaged. The protection features include:

Latch/Auto Recovery Function

The FSL137H provides additional protections by the VIN pin, such as pull-HIGH latch and pull-LOW auto recovery that depend on the application. As shown in Figure 28, when V_{IN} is higher than 4.7V, FSL137H is latched until the V_{DD} is discharged. FSL137H is in auto recovery when V_{IN} is lower than 0.3V.

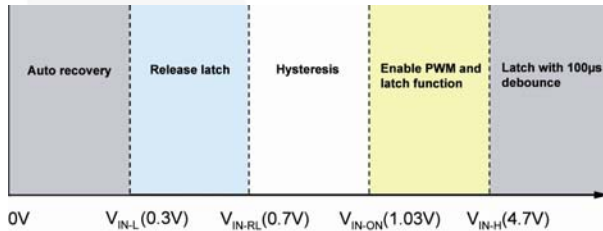

Figure 28. VIN Pin Function

Open-Loop / Overload Protection (OLP)

When the upper branch of the voltage divider for the shunt regulator (KA431 shown) is broken, as shown in Figure 29, or over current or output short occurs. There is no current flowing through the opto-coupler transistor, which pulls up the feedback voltage to 6V. When the feedback voltage is above 4.6V for longer than 56ms, OLP is triggered. This protection is also triggered when the SMPS output drops below the nominal value longer than 56ms due to the overload condition.

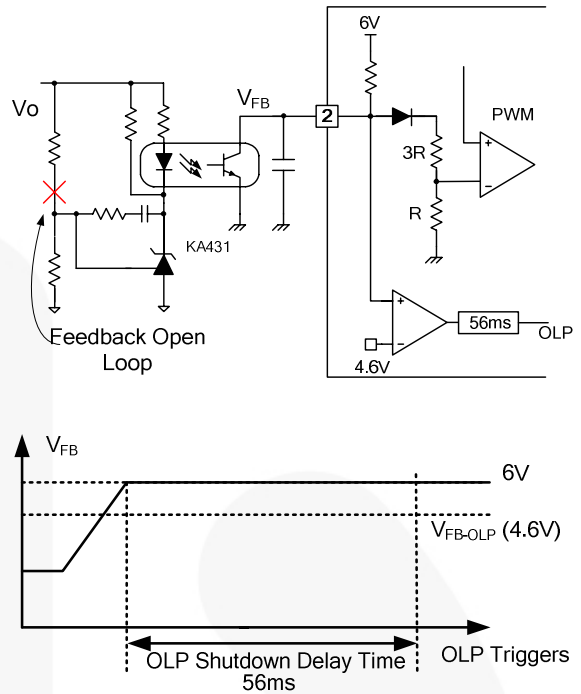

Figure 29. OLP Operation

V_{DD} Over-Voltage Protection (OVP)

V_{DD} over-voltage protection prevents IC damage caused by over voltage on the V_{DD} pin. The OVP is triggered when V_{DD} reaches 28V. It has a debounce time (typically 130µs) to prevent false trigger by switching noise.

Over-Temperature Protection (OTP)

The SenseFET and the control IC are integrated, making it easier to detect the temperature of the SenseFET. When the temperature exceeds approximately 142°C, thermal shutdown is activated.

Physical Dimensions

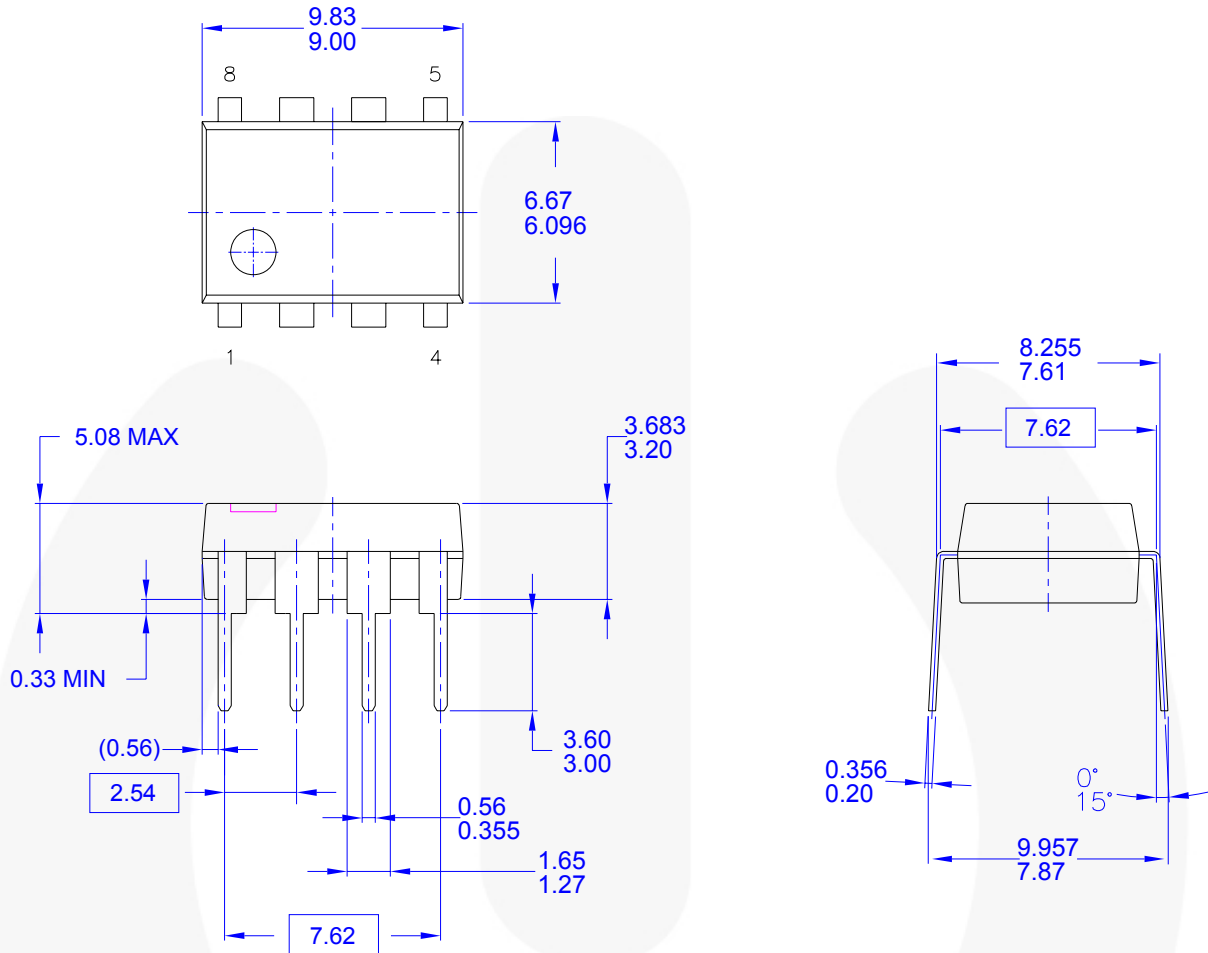

- NOTES: UNLESS OTHERWISE SPECIFIED
- A) THIS PACKAGE CONFORMS TO JEDEC MS-001 VARIATION BA
 - B) ALL DIMENSIONS ARE IN MILLIMETERS.
 - C) DIMENSIONS ARE EXCLUSIVE OF BURRS, MOLD FLASH, AND TIE BAR EXTRUSIONS.
 - D) DIMENSIONS AND TOLERANCES PER ASME Y14.5M-1994
 - E) DRAWING FILENAME AND REVISION: MKT-N08FRE2.

Figure 30.8-Pin Dual In-Line Package (DIP)

Package drawings are provided as a service to customers considering Fairchild components. Drawings may change in any manner without notice. Please note the revision and/or date on the drawing and contact a Fairchild Semiconductor representative to verify or obtain the most recent revision. Package specifications do not expand the terms of Fairchild's worldwide terms and conditions, specifically the warranty therein, which covers Fairchild products.

Always visit Fairchild Semiconductor's online packaging area for the most recent package drawings:
<http://www.fairchildsemi.com/packaging/>.



TRADEMARKS

The following includes registered and unregistered trademarks and service marks, owned by Fairchild Semiconductor and/or its global subsidiaries, and is not intended to be an exhaustive list of all such trademarks.

- | | | | |
|--------------------------|------------------------|---------------------------------------|----------------------|
| AccuPower™ | FPST™ | PowerTrench® | The Power Franchise® |
| Auto-SPM™ | F-PFST™ | PowerXS™ | |
| Build it Now™ | FRFET® | Programmable Active Droop™ | TinyBoost™ |
| CorePLUS™ | Global Power Resource™ | QFET® | TinyBuck™ |
| CorePOWER™ | Green FPS™ | QS™ | TinyCalc™ |
| CROSSVOLT™ | Green FPS™ e-Series™ | Quiet Series™ | TinyLogic® |
| CTL™ | Gmax™ | RapidConfigure™ | TINYOPTO™ |
| Current Transfer Logic™ | GTQ™ | | TinyPower™ |
| EcoSPARK® | IntelliMAX™ | Saving our world, 1mW/W/kW at a time™ | TinyPWM™ |
| EfficientMax™ | ISOPLANAR™ | SignalWise™ | TinyWire™ |
| EZSWITCH™ | MegaBuck™ | SmartMax™ | TriFault Detect™ |
| | MICROCOUPLER™ | SMART START™ | TRUECURRENT™ |
| | MicroFET™ | SPM® | µSerDes™ |
| Fairchild® | MicroPak™ | STEALTH™ | |
| Fairchild Semiconductor® | MillerDrive™ | SuperFET™ | UHC® |
| FACT Quiet Series™ | MotionMax™ | SuperSOT™-3 | Ultra FRFET™ |
| FACT® | Motion-SPM™ | SuperSOT™-6 | UniFET™ |
| FAST® | OPTOLOGIC® | SuperSOT™-8 | VCX™ |
| FastvCore™ | OPTOPLANAR® | SupreMOS™ | VisualMax™ |
| FETBench™ | | SyncFET™ | XST™ |
| FlashWriter® | PDP SPM™ | Sync-Lock™ | |
| | Power-SPM™ | | |

* Trademarks of System General Corporation, used under license by Fairchild Semiconductor.

DISCLAIMER

FAIRCHILD SEMICONDUCTOR RESERVES THE RIGHT TO MAKE CHANGES WITHOUT FURTHER NOTICE TO ANY PRODUCTS HEREIN TO IMPROVE RELIABILITY, FUNCTION, OR DESIGN. FAIRCHILD DOES NOT ASSUME ANY LIABILITY ARISING OUT OF THE APPLICATION OR USE OF ANY PRODUCT OR CIRCUIT DESCRIBED HEREIN; NEITHER DOES IT CONVEY ANY LICENSE UNDER ITS PATENT RIGHTS, NOR THE RIGHTS OF OTHERS. THESE SPECIFICATIONS DO NOT EXPAND THE TERMS OF FAIRCHILD'S WORLDWIDE TERMS AND CONDITIONS, SPECIFICALLY THE WARRANTY THEREIN, WHICH COVERS THESE PRODUCTS.

LIFE SUPPORT POLICY

FAIRCHILD'S PRODUCTS ARE NOT AUTHORIZED FOR USE AS CRITICAL COMPONENTS IN LIFE SUPPORT DEVICES OR SYSTEMS WITHOUT THE EXPRESS WRITTEN APPROVAL OF FAIRCHILD SEMICONDUCTOR CORPORATION.

As used herein:

1. Life support devices or systems are devices or systems which, (a) are intended for surgical implant into the body or (b) support or sustain life, and (c) whose failure to perform when properly used in accordance with instructions for use provided in the labeling, can be reasonably expected to result in a significant injury of the user.
2. A critical component in any component of a life support, device, or system whose failure to perform can be reasonably expected to cause the failure of the life support device or system, or to affect its safety or effectiveness.

ANTI-COUNTERFEITING POLICY

Fairchild Semiconductor Corporation's Anti-Counterfeiting Policy. Fairchild's Anti-Counterfeiting Policy is also stated on our external website, www.fairchildsemi.com, under Sales Support.

Counterfeiting of semiconductor parts is a growing problem in the industry. All manufacturers of semiconductor products are experiencing counterfeiting of their parts. Customers who inadvertently purchase counterfeit parts experience many problems such as loss of brand reputation, substandard performance, failed applications, and increased cost of production and manufacturing delays. Fairchild is taking strong measures to protect ourselves and our customers from the proliferation of counterfeit parts. Fairchild strongly encourages customers to purchase Fairchild parts either directly from Fairchild or from Authorized Fairchild Distributors who are listed by country on our web page cited above. Products customers buy either from Fairchild directly or from Authorized Fairchild Distributors are genuine parts, have full traceability, meet Fairchild's quality standards for handling and storage and provide access to Fairchild's full range of up-to-date technical and product information. Fairchild and our Authorized Distributors will stand behind all warranties and will appropriately address any warranty issues that may arise. Fairchild will not provide any warranty coverage or other assistance for parts bought from Unauthorized Sources. Fairchild is committed to combat this global problem and encourage our customers to do their part in stopping this practice by buying direct or from authorized distributors.

PRODUCT STATUS DEFINITIONS

Definition of Terms

Datasheet Identification	Product Status	Definition
Advance Information	Formative / In Design	Datasheet contains the design specifications for product development. Specifications may change in any manner without notice.
Preliminary	First Production	Datasheet contains preliminary data; supplementary data will be published at a later date. Fairchild Semiconductor reserves the right to make changes at any time without notice to improve design.
No Identification Needed	Full Production	Datasheet contains final specifications. Fairchild Semiconductor reserves the right to make changes at any time without notice to improve the design.
Obsolete	Not In Production	Datasheet contains specifications on a product that is discontinued by Fairchild Semiconductor. The datasheet is for reference information only.

Rev. 142