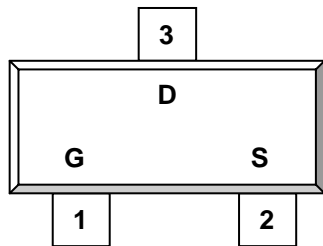

DESCRIPTION

ST2342 is the N-Channel logic enhancement mode power field effect transistor which is produced using high cell density, DMOS trench technology. This high density process is especially tailored to minimize on-state resistance. These devices are particularly suited for low voltage application such as cellular phone and notebook computer power management, other battery powered circuits, and low in-line power loss are required. The product is in a very small outline surface mount package.

PIN CONFIGURATION
SOT-23-3L

1.Gate 2.Source 3.Drain

FEATURE

- 20V/4.8A, $R_{DS(ON)} = 26m\Omega$ (Typ.) @ $V_{GS} = 4.5V$
- 20V/4.5A, $R_{DS(ON)} = 28m\Omega$ @ $V_{GS} = 2.5V$
- 20V/4.0A, $R_{DS(ON)} = 36m\Omega$ @ $V_{GS} = 1.8V$
- Super high density cell design for extremely low $R_{DS(ON)}$
- Exceptional on-resistance and maximum DC current capability
- SOT-23 package design

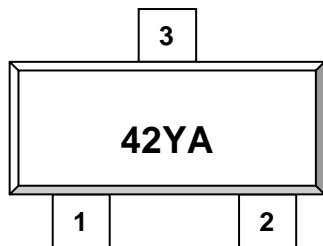
PART MARKING
SOT-23-3L

Y: Year Code A: Process Code

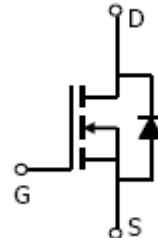

ORDERING INFORMATION

Part Number	Package	Part Marking
ST2342S23RG	SOT-23L	42YA

※ Process Code : A ~ Z ; a ~ z

※ ST2342S23RG S23 : SOT-3L23 ; R : Tape Reel ; G : Pb - Free



ST2342 

N Channel Enhancement Mode MOSFET

5.0A

ABSOLUTE MAXIMUM RATINGS (Ta = 25°C Unless otherwise noted)

Parameter	Symbol	Typical	Unit
Drain-Source Voltage	V _{DSS}	20	V
Gate-Source Voltage	V _{GSS}	±12	V
Continuous Drain Current (T _J =150°C)	I _D	T _A =25°C 5.0	A
		T _A =70°C 4.0	
Pulsed Drain Current	I _{DM}	13	A
Continuous Source Current (Diode Conduction)	I _S	1.0	A
Power Dissipation	P _D	T _A =25°C 1.25	W
		T _A =70°C 0.8	
Operation Junction Temperature	T _J	150	°C
Storage Temperature Range	T _{STG}	-55/150	°C
Thermal Resistance-Junction to Ambient	R _{θJA}	140	°C/W

ELECTRICAL CHARACTERISTICS (Ta = 25°C Unless otherwise noted)

Parameter	Symbol	Condition	Min	Typ	Max	Unit
Static						
Drain-Source Breakdown Voltage	$V_{(BR)DSS}$	$V_{GS}=0V, I_D=250\mu A$	20			V
Gate Threshold Voltage	$V_{GS(th)}$	$V_{DS}=V_{GS}, I_D=250\mu A$	0.4		1.0	V
Gate Leakage Current	I_{GSS}	$V_{DS}=0V, V_{GS}=\pm 12V$			± 100	nA
Zero Gate Voltage Drain Current	I_{DSS}	$V_{DS}=20V, V_{GS}=0V$			1	uA
		$V_{DS}=20V, V_{GS}=0V$ $T_J=55^\circ C$			10	
On-State Drain Current	$I_{D(on)}$	$V_{DS} \geq 5V, V_{GS}=4.5V$	6			A
Drain-source On-Resistance	$R_{DS(on)}$	$V_{GS}=4.5V, I_D=5.0A$		0.026		Ω
		$V_{GS}=2.5V, I_D=4.5A$		0.028		
		$V_{GS}=1.8V, I_D=4.0A$		0.036		
Forward Transconductance	g_{fs}	$V_{DS}=15V, I_D=4.8A$		30		S
Diode Forward Voltage	V_{SD}	$I_S=1.0A, V_{GS}=0V$		0.8	1.2	V
Dynamic						
Total Gate Charge	Q_g	$V_{DS}=10V$ $V_{GS}=4.5V$ $I_D=4.8A$		10	13	nC
Gate-Source Charge	Q_{gs}			1.4		
Gate-Drain Charge	Q_{gd}			2.1		
Input Capacitance	C_{iss}	$V_{DS}=10V$ $V_{GS}=0V$ $F=1MHz$		600		pF
Output Capacitance	C_{oss}			120		
Reverse Transfer Capacitance	C_{rss}			100		
Turn-On Time	$t_{d(on)tr}$	$V_{DD}=10V$ $R_L=10\Omega$ $I_D=1.0A$ $V_{GEN}=4.5V$ $R_G=6\Omega$		15	25	nS
				40	60	
Turn-Off Time	$t_{d(off)tf}$			45	65	
				30	40	

TYPICAL CHARACTERISTICS (25°C Unless noted)

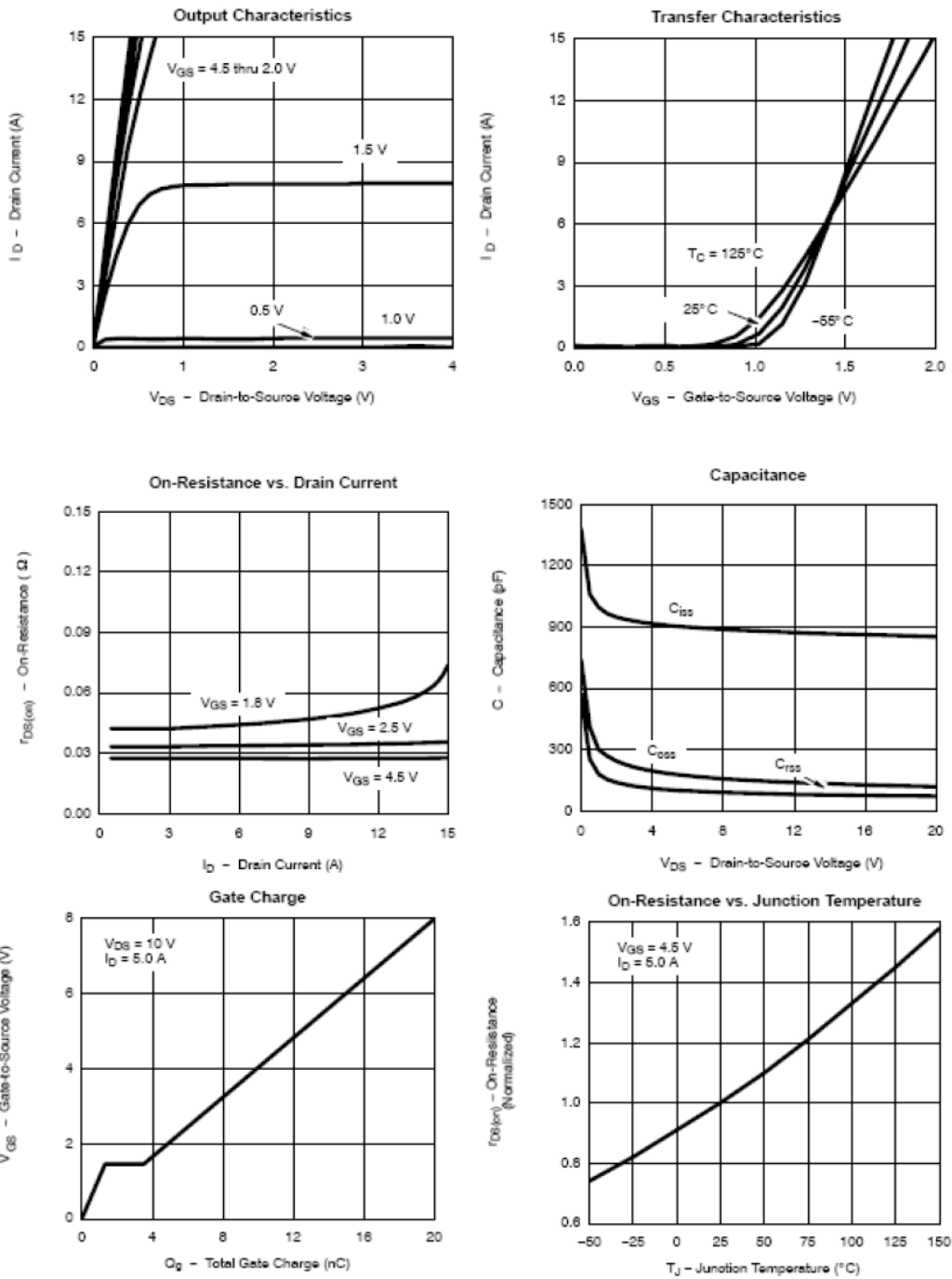

TYPICAL CHARACTERISTICS (25°C Unless noted)

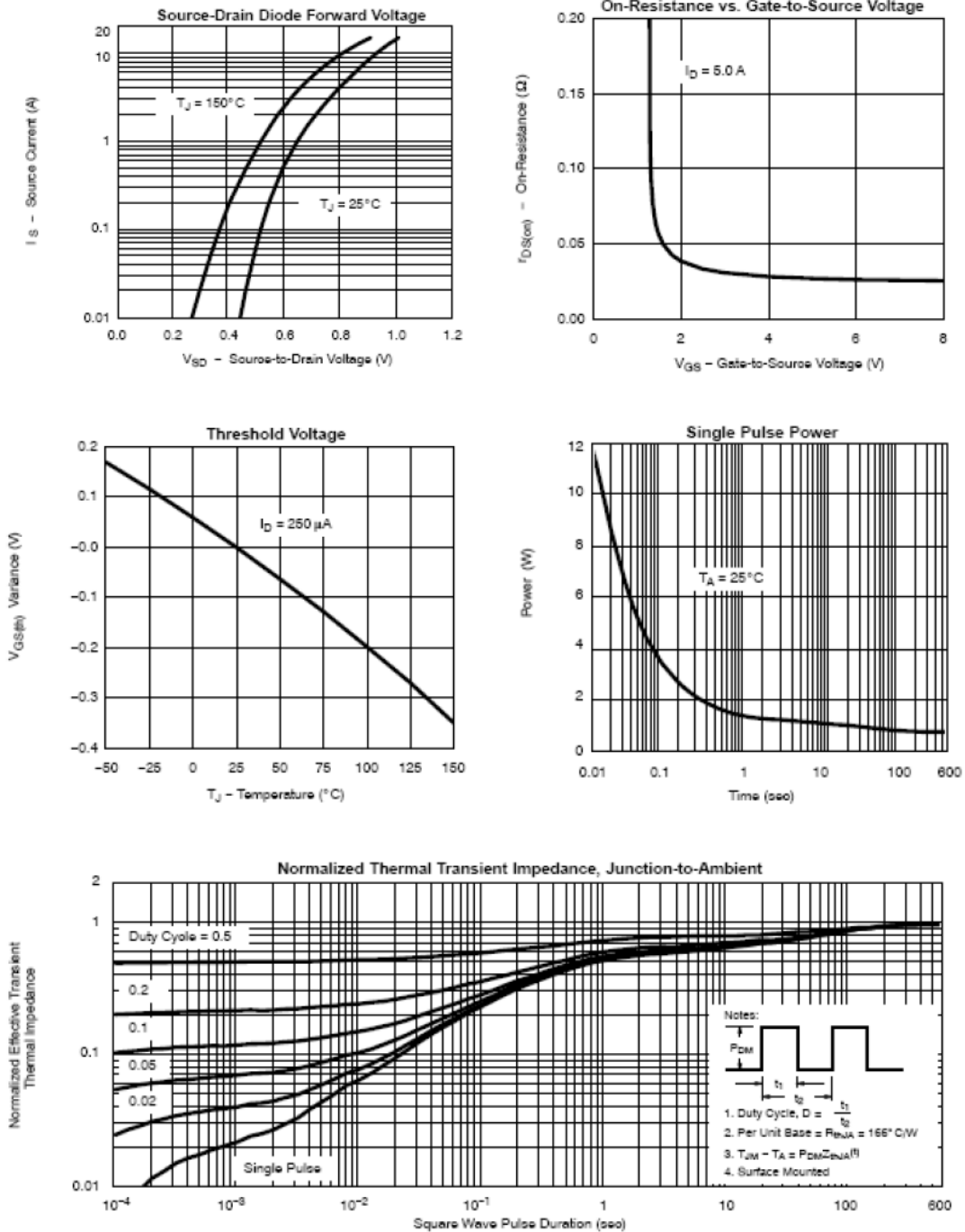

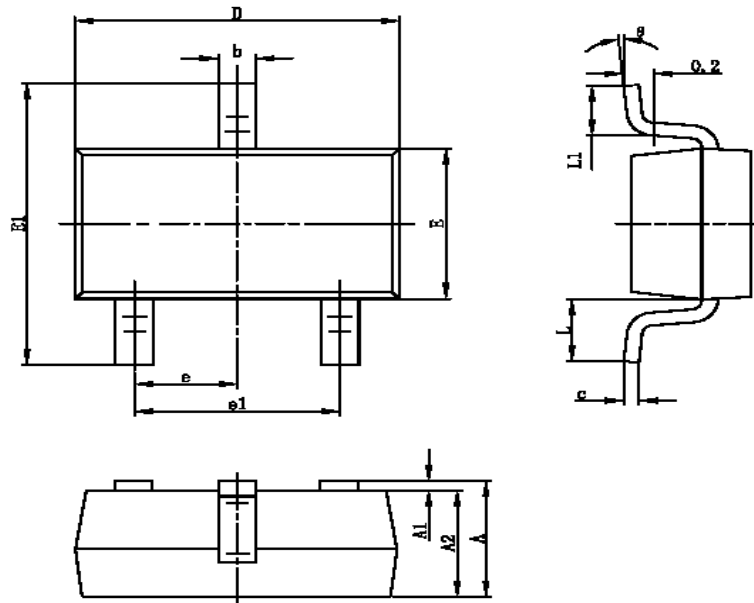
SOT-23L PACKAGE OUTLINE

Symbol	Dimensions In Millimeters		Dimensions In Inches	
	Min	Max	Min	Max
A	1.050	1.250	0.041	0.049
A1	0.000	0.100	0.000	0.004
A2	1.050	1.150	0.041	0.045
b	0.300	0.400	0.012	0.016
c	0.100	0.200	0.004	0.008
D	2.820	3.020	0.111	0.119
E	1.500	1.700	0.059	0.067
E1	2.650	2.950	0.104	0.116
e	0.950TYP		0.037TYP	
e1	1.800	2.000	0.071	0.079
L	0.700REF		0.028REF	
L1	0.300	0.600	0.012	0.024
θ	0°	8°	0°	8°