

Helping Customers Innovate, Improve & Grow



VX-500

### Features

- 9X14 J Leaded Surface Mount Package
- Reflow Process Compatible Optional
- AC MOS, TTL and LVPECL
- Frequency Range: 1 MHz to 800 MHz
- Previous Model: C5300, MC044, MC344, MC046, MC346, MC047, MC347, MC049, MC349, MC048, MC318, MC328, and MC348

### Applications

- Base Stations
- Test Equipment
- Telecom & Wireless Infrastructure
- Digital Switching

## Performance Specifications

Parameter	Min	Typ	Max	Units	Condition
<b>Frequency Stabilities<sup>1</sup></b>					
vs. operating temperature range (absolute pull range)					-40... +85°C 0... +70°C
vs. supply voltage change	-2		+2	ppm	Vs ± 5%
vs. load change	-1		+1	ppm	Load ± 5%
vs aging / 1 year	-5	±3	+5	ppm	
vs aging / year (following years)	-1		+1	ppm	
<b>Supply Voltage (Vs)</b>					
Supply voltage	4.75	5.0	5.25	VDC	
Current consumption			15 20 40 100	mA mA mA mA	ACMOS/TTL 1 to 23.9 MHz ACMOS/TTL 24 to 49.9 MHz ACMOS/TTL 50 to 80.0 MHz LVPECL No load
Supply voltage	3.135	3.3	3.465	VDC	
Current consumption			6 8 12 16 60 100	mA mA mA mA mA mA	ACMOS 1.0 to 14.90 MHz ACMOS 15.0 TO 39.9 MHz ACMOS 40.0 TO 59.9 MHz ACMOS 60.0 TO 79.9 MHz ACMOS 80.0 to 125.0 MHz LVPECL No load

## Performance Specifications

Parameter	Min	Typ	Max	Units	Condition
<b>RF Output</b>					
Signal	ACMOS				
Load		15	50	pF	
Signal Level (Vol)			0.5 0.3	VDC VDC	Vs= 5.0V and 15pF load Vs= 3.3V and 15pF load
Signal Level (Voh)	4.5 3.0			VDC VDC	Vs= 5.0V and 15pF load Vs= 3.3V and 15pF load
Rise and fall times for ACMOS (measured 10% to 90%)			10 5 3	ns ns ns	1.0 to 23.9 MHz 24.0 to 79.7 MHz 80.0 to 125.0 MHz
Duty cycle	45 40		55 60	% %	@ 50% < 15 MHz @ 50% >= 15 MHz
Signal	TTL				
Load			10	pF	
Signal Level (Vol)			0.5	VDC	Vs= 5.0V and 15pF load
Signal Level (Voh)	4.5			VDC	Vs= 5.0V and 15pF load
Rise and fall times for TTL (measured 0.8V to 2.0V)			5 3	ns ns	1.0 to 23.9 MHz 24.0 to 125.0 MHz
Duty cycle	45 40		55 60	% %	@ 1.4V < 15 MHz @ 1.4V >= 15 MHz
Signal	PECL/LVPECL				
Load			50	ohm	Into Vs-2V or There in Equivalent
Signal Level (Vol)			Vs -1.62	VDC	
Signal Level (Voh)	Vs -1.025			VDC	
Rise and fall times (measured 20% to 80%)			1000 600	ps ps	<100 MHz >100 MHz
Start-up Time			10	ms	
Duty cycle (LVPECL)	45 40		55 60	% %	@ 50% Vdd @ 50% Vdd
Jitter (rms)			5 1	ps ps	BW = 10Hz to 20 MHz BW = 12 kHz to 20 MHz
Period Jitter (pk-pk)			40	ps	10,000 samples- Rising edge
<b>Frequency Tuning (EFC)</b>					
Absolute Pull Range		±30 ±50		ppm ppm	
Linearity		10	15	%	
Tuning Slope	Positive				
Control Voltage Range	0.5 0.3	2.5 1.65	4.5 3.0	VDC VDC	with Vs=5.0VDC with Vs=3.3VDC
<b>Additional Parameters</b>					
Phase Noise <sup>3</sup> (@ 52 MHz)			-60 -90 -120 -140 -145	dBc/Hz dBc/Hz dBc/Hz dBc/Hz dBc/Hz	10 Hz 100 Hz 1 KHz 10 KHz 100 KHz

## Performance Specifications

Parameter	Min	Typ	Max	Units	Condition
Phase Noise <sup>3</sup> (@ 155.52 MHz)			-50	dBc/Hz	10 Hz
			-80	dBc/Hz	100 Hz
			-110	dBc/Hz	1 kHz
			-133	dBc/Hz	10 KHz
			-145	dBc/Hz	100 KHz
Weight			<2.0	g	
Processing & Packing					Handling & processing note
Output Enable <sup>6</sup>	Logic "0" input = Outputs disabled (Tri-state) Logic "1" or floating input = Outputs enabled				ACMOS/TTL Output
	Logic "0" or floating input = Outputs enabled Logic "1" input = Outputs disabled (Tri-state)				PECL/LVPECL Output
Absolute Maximum Ratings					
Supply voltage (Vs)			7.0	V	with Vs=5.0 and 3.3 VDC
Operable temperature range	-55		+85	°C	
Storage temperature range	-55		+125	°C	

## Outline Drawing / Enclosure

Dimensions: Inches (mm)

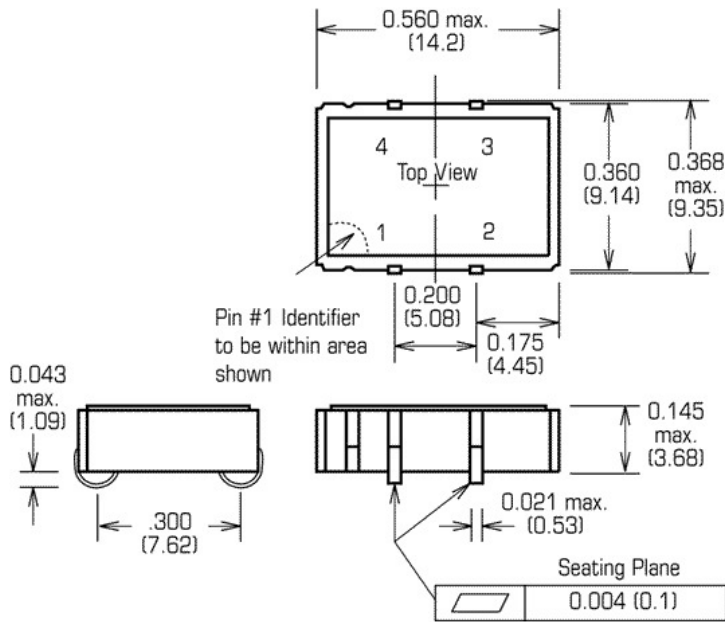

Type A (ACMOS/TTL)		
Code	Height "H"	Pin Length
0	3.68	1.09

Pin Connections	
1	VCXO input
2	Ground (Case)
3	RF Output
4	Supply

## Outline Drawing / Enclosure

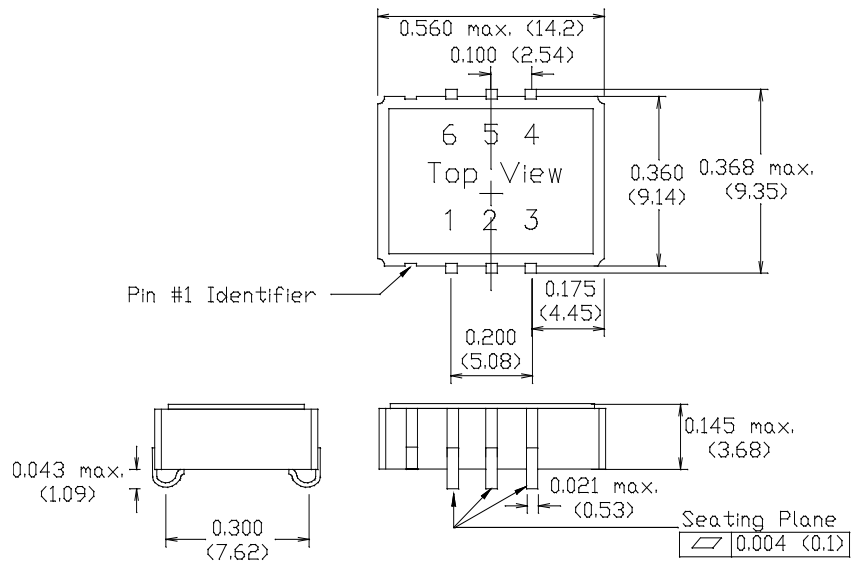

Type B (ACMOS/TTL)		
Code	Height "H"	Stand-off
1	3.68	1.09

Type B (PECL/LVPECL)		
Code	Height "H"	Stand-off
1	3.68	1.09

Pin Connections	
1	VCXO input
2	Enable/Disable or N/C
3	Ground (Case)
4	RF Output
5	N/C
6	Supply Voltage

Pin Connections	
1	VCXO input
2	Enable/Disable or N/C
3	Ground (Case)
4	RF Output
5	Complementary Output
6	Supply Voltage

## Ordering Information

**VX - 500 0 - D A T - K X X X - 10M000000**

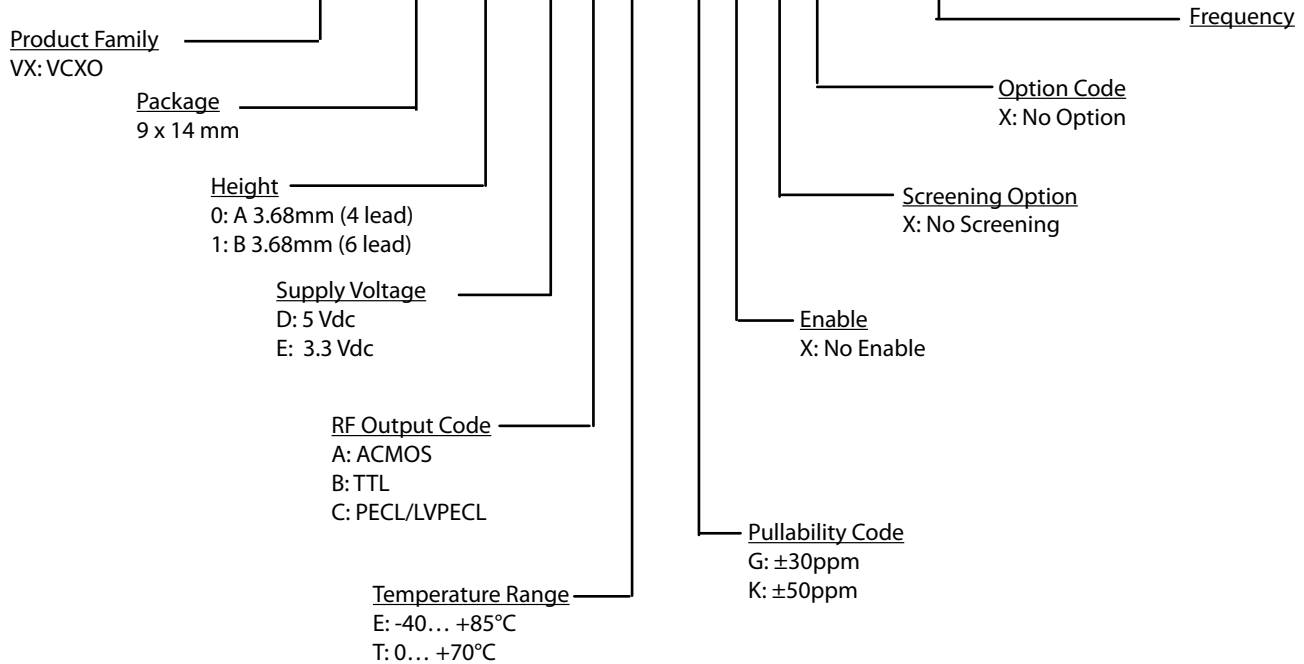

**Notes:**

1. Contact factory for improved stabilities or additional product options. Not all options and codes are available at all frequencies.
2. Unless other stated all values are valid after warm-up time and refer to typical conditions for supply voltage, frequency control voltage, load, temperature (25°C).
3. Phase noise degrades with increasing output frequency.
4. Subject to technical modification.
5. Contact factory for availability.

## For Additional Information, Please Contact

**USA:**

Vectron International  
267 Lowell Road  
Hudson, NH 03051  
Tel: 1.888.328.7661  
Fax: 1.888.329.8328

**Europe:**

Vectron International  
Landstrasse, D-74924  
Neckarbischofsheim, Germany  
Tel: +49 (0) 3328.4784.17  
Fax: +49 (0) 3328.4784.30

**Asia:**

Vectron International  
1F-2F, No 8 Workshop, No 308 Fenju Road  
WaiGaoQiao Free Trade Zone  
Pudong, Shanghai, China 200131  
Tel: 86.21.5048.0777  
Fax: 86.21.5048.1881

**Disclaimer**

Vectron International reserves the right to make changes to the product(s) and or information contained herein without notice. No liability is assumed as a result of their use or application. No rights under any patent accompany the sale of any such product(s) or information.

Rev: 12/12/2008 daf