



# CHENMKO ENTERPRISE CO.,LTD

**KBPC35005PT**

**THRU**

**KBPC3510PT**

*Lead free devices*

## SINGLE-PHASE GLASS PASSIVATED SILICON BRIDGE RECTIFIER

VOLTAGE RANGE 50 - 1000 Volts CURRENT 35.0 Amperes

### FEATURES

- \* Superior thermal design
- \* 400 amperes surge rating
- \* 1/4" universal faston terminal
- \* Hole thru for # 8 screw

### MECHANICAL DATA

**Case:** JEDEC KBPC-35 molded plastic  
**Terminals:** Plated leads solderable per MIL-STD-750, Method 2026  
**Mounting position:** Any  
**Polarity:** Polarity symbols marked on body

### MAXIMUM RATINGS AND ELECTRICAL CHARACTERISTICS

Ratings at 25°C ambient temperature unless otherwise specified.  
 Single phase, half wave, 60 Hz, resistive or inductive load.  
 For capacitive load, derate current by 20%.

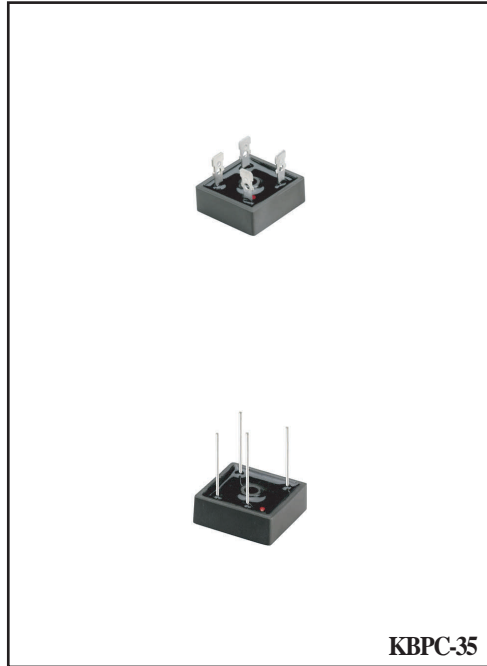

**KBPC-35**

**MAXIMUM RATINGS** ( At TA = 25°C unless otherwise noted )

RATINGS	SYMBOL	KBPC35005PT	KBPC3501PT	KBPC3502PT	KBPC3504PT	KBPC3506PT	KBPC3508PT	KBPC3510PT	UNITS
Maximum Recurrent Peak Reverse Voltage	VRRM	50	100	200	400	600	800	1000	Volts
Maximum RMS Voltage	VRMS	35	70	140	280	420	560	700	Volts
Maximum DC Blocking Voltage	Vdc	50	100	200	400	600	800	1000	Volts
Maximum Average Forward Rectified Current at Tc = 55°C	Io	35.0							Amps
Peak Forward Surge Current 8.3 ms single half sine-wave superimposed on rated load (JEDEC method)	IFSM	400							Amps
Operating and Storage Temperature Range	TJ,TSTG	-55 to +150							°C

**ELECTRICAL CHARACTERISTICS** ( At TA = 25°C unless otherwise noted )

CHARACTERISTICS	SYMBOL	KBPC35005PT	KBPC3501PT	KBPC3502PT	KBPC3504PT	KBPC3506PT	KBPC3508PT	KBPC3510PT	UNITS
Maximum Instantaneous Forward Voltage at 17.5 A DC	VF	1.1							Volts
Maximum Reverse Current at rated	IR	10							uAmps
DC blocking Voltage per element		0.5							mAmps

# RATING CHARACTERISTIC CURVE ( KBPC35005PT THRU KBPC3510PT )

FIG. 1 - TYPICAL FORWARD CURRENT DERATING CURVE

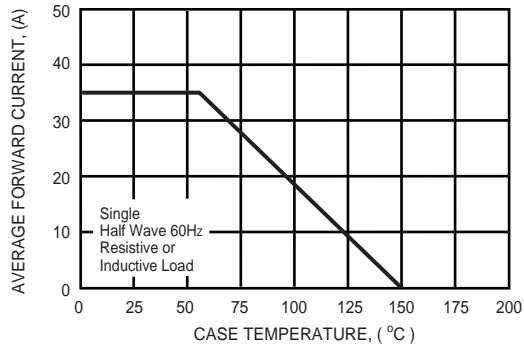

FIG. 2 - MAXIMUM NON-REPETITIVE FORWARD SURGE CURRENT

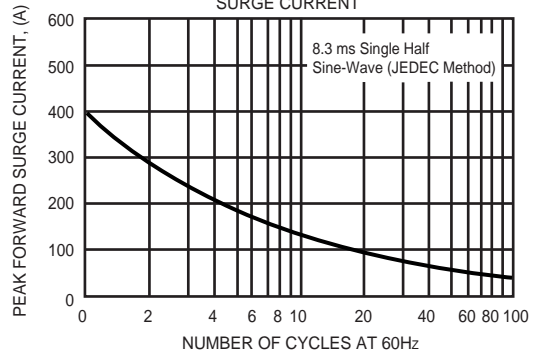

FIG. 3 - TYPICAL INSTANTANEOUS FORWARD CHARACTERISTICS

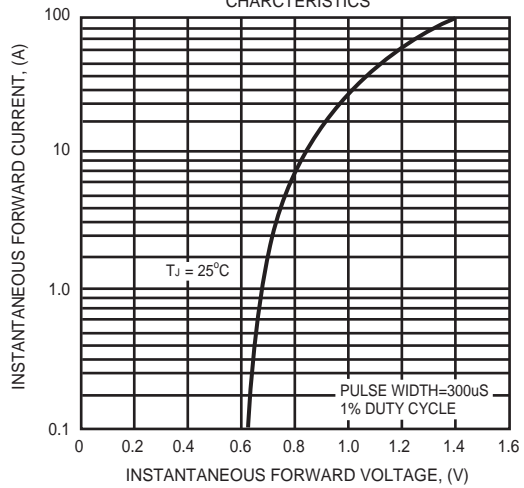
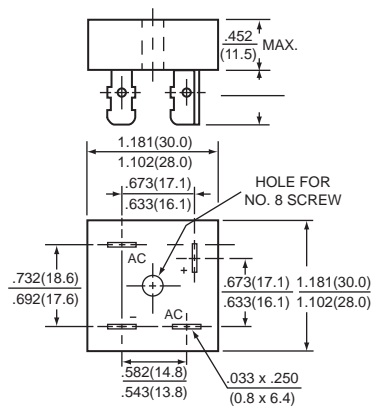
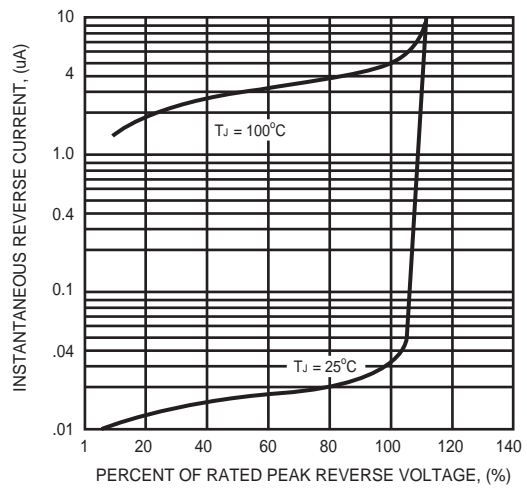
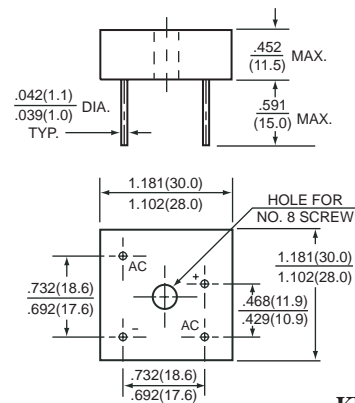

FIG. 4 - TYPICAL REVERSE CHARACTERISTICS



KBPC-35



KBPC-35W