

Distinctive Characteristics

Snap-acting mechanism gives smooth actuation, short stroke, light touch, and audible feedback. This mechanism also provides long mechanical life.

High torque bushing construction prevents rotation or separation from frame during installation.

Antijamming design protects contacts from damage due to excessive downward force on the actuator.

Compatible companions with M series toggles. Body, bushing, and footprint dimensions ideal for mounting MB2400 pushbuttons and M toggles next to one another.

Stainless steel frame resists corrosion.

Longer center solder lug terminal simplifies wiring and soldering.

Silver contacts of specially composed alloy for hardness.

Epoxy sealed terminals prevent entry of solder flux and other contaminants.

Prominent external insulating barriers increase insulation resistance and dielectric strength.

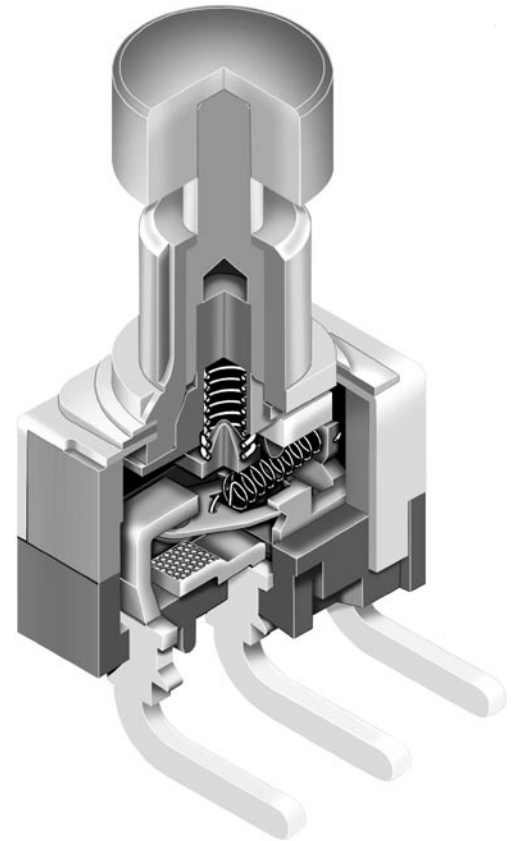

Actual Size

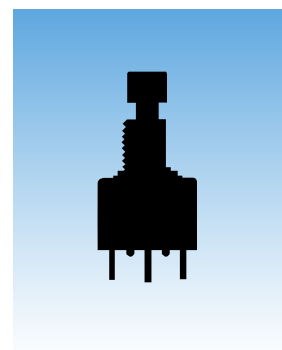

General Specifications

Electrical Capacity (Resistive Load)

Power Level (code W):	3A @ 125V AC
Logic Level (code G):	0.4VA maximum @ 28V AC/DC maximum (Applicable Range 0.1mA ~ 0.1A @ 20mV ~ 28V)
Logic/Power Level (code A):	Combines W & G ratings

Note: Find additional explanation of dual rating & operating range in Supplement section.

Other Ratings

Contact Resistance:	20 milliohms maximum for silver; 30 milliohms maximum for gold
Insulation Resistance:	1,000 megohms minimum @ 500V DC
Dielectric Strength:	1,000V AC minimum between contacts for 1 minute minimum; 1,500V AC minimum between contacts & case for 1 minute minimum
Mechanical Life:	200,000 operations minimum
Electrical Life:	25,000 operations minimum for silver; 100,000 operations minimum for gold
Nominal Operating Force:	Single pole 2.45N; double pole 3.92N
Travel	Pretravel .024" (0.6mm); Overtravel .016" (0.4mm); Total Travel .039" (1.0mm)

Materials & Finishes

Plunger:	Brass with nickel plating
Bushing:	Brass with nickel plating
Frame:	Stainless steel
Case:	Polybutylene terephthalate (PBT)
Base:	Diallyl phthalate resin
Movable Contactor:	Phosphor bronze with silver or gold plating
Movable Contacts:	Silver alloy (code W); copper with gold plating (code G); or silver alloy with gold plating (code A)
Stationary Contacts:	Silver alloy with silver plating (code W); copper or brass with gold plating (code G); or silver with gold plating (code A)
Terminals:	Copper or brass with silver plating; copper or brass with gold plating

Environmental Data

Operating Temp Range:	-30°C through +85°C (-22°F through +185°F)
Humidity:	90 ~ 95% humidity for 96 hours @ 40°C (104°F)
Vibration:	10 ~ 55Hz with peak-to-peak amplitude of 1.5mm traversing the frequency range & returning in 1 minute; 3 right angled directions for 2 hours
Shock:	50G (490m/s ²) acceleration (tested in 6 right angled directions, with 3 shocks in each direction)

Installation

Mounting Torque:	1.5Nm (13.0 lb•in) for double nut; 0.7Nm (6.0 lb•in) for single nut
Cap Installation Force:	80.0N (18.0 lbf) maximum downward force on actuator
Soldering:	Wave Soldering (PC version): See Profile B in Supplement section. Manual Soldering: See Profile B in Supplement section.
Cleaning:	These devices are not process sealed. Hand clean locally using alcohol based solution. See Cleaning Specifications in Supplement section.

Standards & Certifications

Flammability Standards:	UL94V-0 available
UL & C-UL Recognized:	All single and double pole models recognized at 3A @ 125V AC or 0.4VA max. @ 28V DC max; UL File No. WOYR2.E44145; add "/U" to end of part number to order UL mark on switch C-UL File No. WOYR8.E44145; add "/C-UL" to end of part number to order C-UL mark on switch.
CSA Certified:	Single pole models with PC, solder lug, or Wirewrap terminals & double pole with PC or Wirewrap terminals certified at 3A @ 125V AC or 0.4VA @ 28V maximum; CSA File No. 023535-0-000; add "/C" to end of part number to order CSA mark on switch.



TYPICAL SWITCH ORDERING EXAMPLE

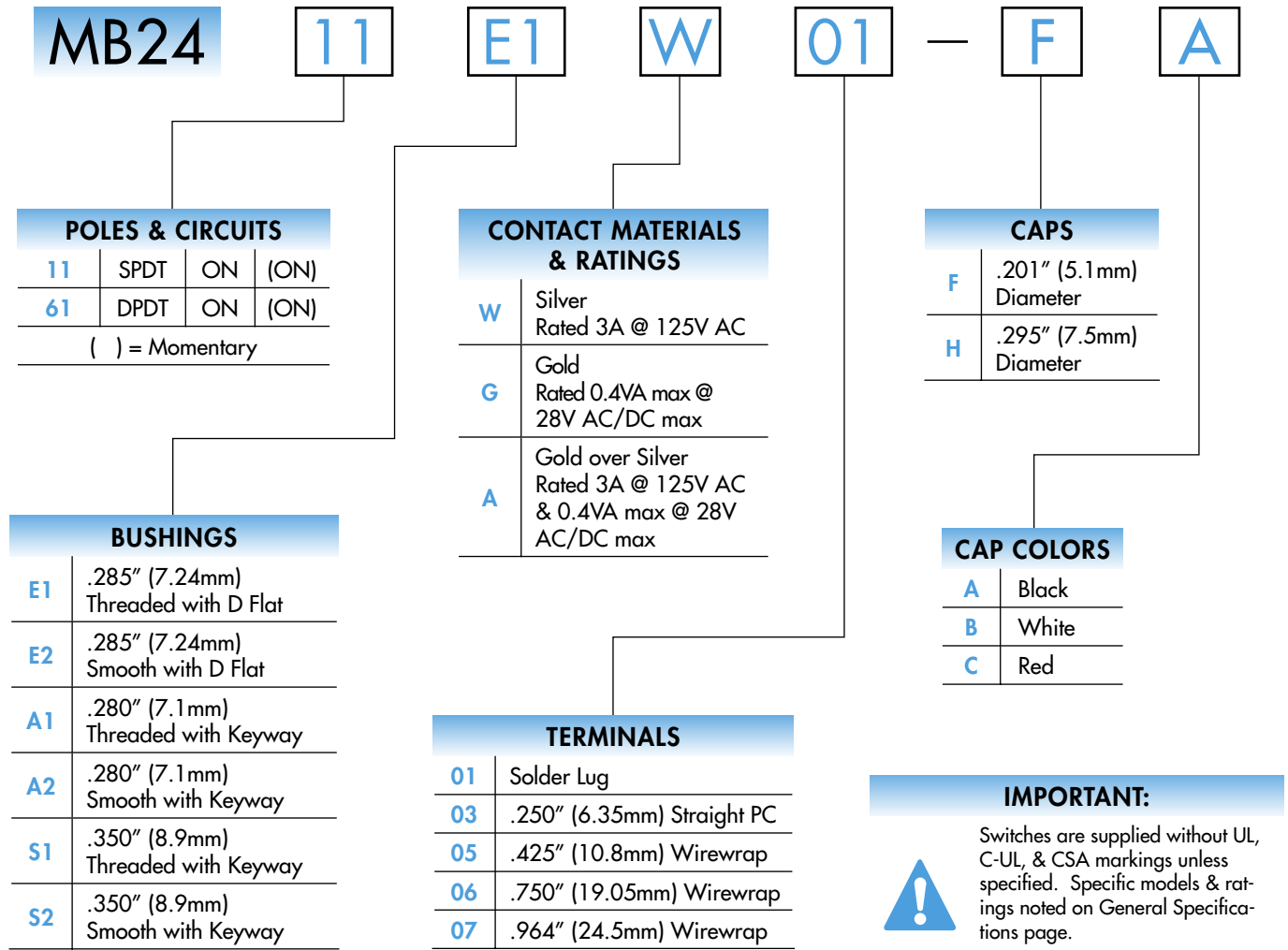





DESCRIPTION FOR TYPICAL ORDERING EXAMPLE

MB2411E1W01-FA

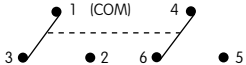

POLES & CIRCUITS

Pole	Model	Plunger Position () = Momentary		Connected Terminals		Throw & Switch Schematics
		Normal  Keyway	Down 	Normal  Keyway	Down 	
SP	MB2411	ON	(ON)	1-3	1-2	SPDT 
DP	MB2461	ON	(ON)	1-3 4-6	1-2 4-5	DPDT 

Note: Terminal numbers are not actually on the switch.

BUSHINGS

Note: Plunger selection is not required for MB2400 pushbuttons. The plunger can be used with or without a cap.

E1 .285" (7.24mm)
Threaded with D Flat

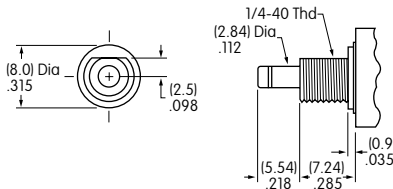

Maximum Panel Thickness with Standard Hardware: .068" (1.74mm)

A1 .280" (7.1mm)
Threaded with Keyway

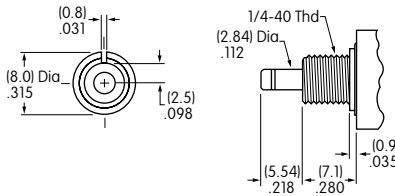

Maximum Panel Thickness with Standard Hardware: .068" (1.74mm)

S1 .350" (8.9mm)
Threaded with Keyway

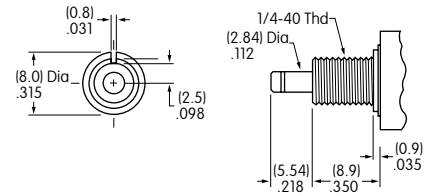

Maximum Panel Thickness with Standard Hardware: .134" (3.40mm)

E2 .285" (7.24mm)
Smooth with D Flat

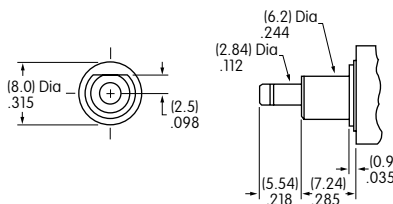

A2 .280" (7.1mm)
Smooth with Keyway

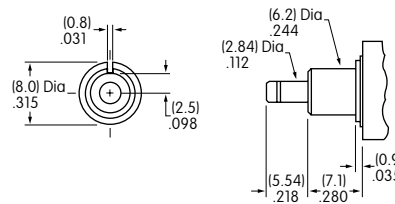

S2 .350" (8.9mm)
Smooth with Keyway

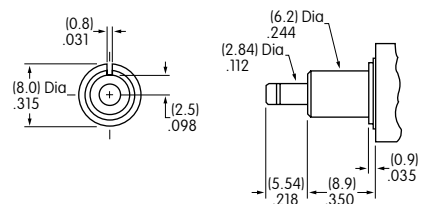

Panel Cutouts

For A1, A2, S1, or S2 Bushing
with Keyway

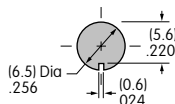

For E1 or E2 Bushing
with D Flat

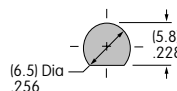

With
Optional Locking Ring

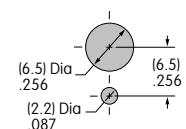

Standard hardware includes 2 hex nuts & 1 lockwasher.
Hardware is illustrated following the Typical Switch Dimension drawings.

CONTACT MATERIALS & RATINGS

W	Silver over Silver	Power Level	3A @ 125V AC
G	Gold over Brass or Copper	Logic Level	0.4VA maximum @ 28V AC/DC maximum
Note: Complete explanation of operating range in Supplement section.			
A	Gold over Silver	Power Level or Logic Level	3A @ 125V AC or 0.4VA maximum @ 28V AC/DC maximum

Note: This dual rated option is suitable when two or more identical switches are used in logic and in power circuits within the same application. See Supplement section for complete explanation of dual rating and operating range.

TERMINALS

01	Solder Lug	03	.250" (6.35mm) Straight PC	05	.425" (10.8mm) Wirewrap or Extended PC
Single Pole		Double Pole		<p>Refer to the footprints if using as extended PC terminal.</p> <p>Dimension A = terminal lengths as shown beside the code boxes above.</p>	
06		.750" (19.05mm) Wirewrap or Extended PC		07	
				.964" (24.5mm) Wirewrap or Extended PC	

CAPS & CAP COLORS

F **AT475**
.201" (5.1mm)
Diameter Cap

Material: Polyamide

Finish: Glossy

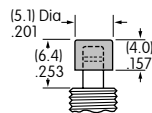

H **AT496**
.295" (7.5mm)
Diameter Cap

Material: Polyamide

Finish: Glossy

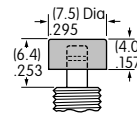

Cap Colors Available:

A Black

B White

C Red

TYPICAL SWITCH DIMENSIONS

Solder Lug

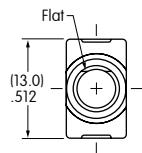

Single Pole

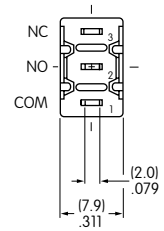
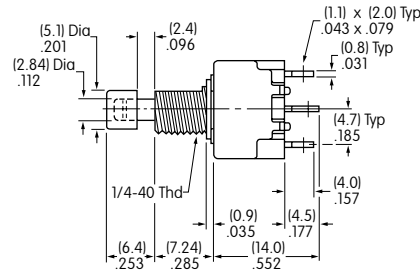

MB2411E1W01-FA

Solder Lug

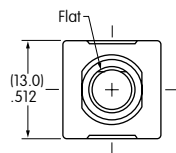

Double Pole

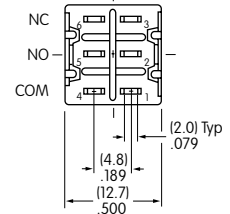
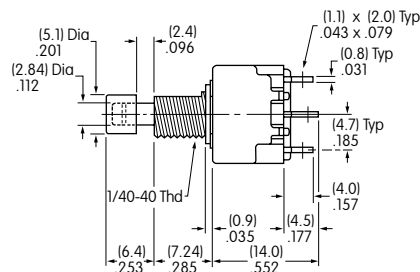

MB2461E1W01-FA

HARDWARE

Standard Hardware

AT513H Inch Threaded Hexagon Nut

2 included with each switch

Material:
Brass with Nickel Plating

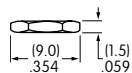
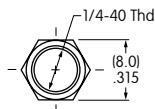

AT509 Lockwasher

1 included with each switch

Material:
Steel with Zinc/Chromate

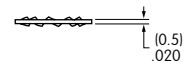
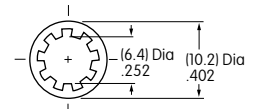

Optional Hardware

AT507H Locking Ring for A1 or S1 Bushing

Material:
Steel with Zinc/Chromate

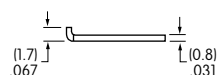
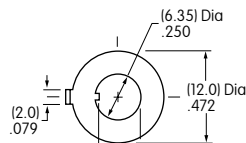

AT515 Locking Ring for E1 Bushing

Material:
Steel with Zinc/Chromate

