

Schottky Rectifier, 2 x 10 A

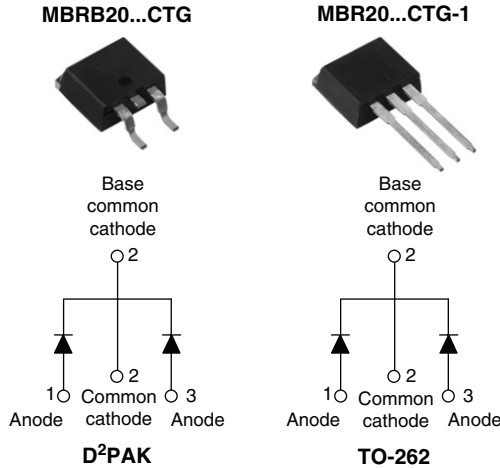

FEATURES

- 150 °C T_J operation
- Center tap D²PAK and TO-262 packages
- Low forward voltage drop
- High purity, high temperature epoxy encapsulation for enhanced mechanical strength and moisture resistance
- High frequency operation
- Guard ring enhanced ruggedness and long term reliability
- Designed and qualified for AEC Q101 level

DESCRIPTION

This center tap Schottky rectifier has been optimized for low reverse leakage at high temperature. The proprietary barrier technology allows for reliable operation up to 150 °C junction temperature. Typical applications are in switching power supplies, converters, freewheeling diodes, and reverse battery protection.

PRODUCT SUMMARY

$I_{F(AV)}$	2 x 10 A
V_R	80 to 100 V

MAJOR RATINGS AND CHARACTERISTICS

SYMBOL	CHARACTERISTICS	VALUES	UNITS
I_{FRM}	$T_C = 133\text{ °C}$ (per leg)	20	A
V_{RRM}		80 to 100	V
I_{FSM}	$t_p = 5\ \mu\text{s}$ sine	850	A
V_F	10 Apk, $T_J = 125\text{ °C}$	0.70	V
T_J	Range	- 65 to 150	°C

VOLTAGE RATINGS

PARAMETER	SYMBOL	MBRB2080CTG MBR2080CTG-1	MBRB2090CTG MBR2090CTG-1	MBRB20100CTG MBR20100CTG-1	UNITS
Maximum DC reverse voltage	V_R	80	90	100	V
Maximum working peak reverse voltage	V_{RWM}				

MBRB20...CTG, MBR20...CTG-1



Vishay High Power Products

Schottky Rectifier,
2 x 10 A

ABSOLUTE MAXIMUM RATINGS						
PARAMETER	SYMBOL	TEST CONDITIONS		VALUES	UNITS	
Maximum average forward current	$I_{F(AV)}$	$T_C = 133\text{ }^\circ\text{C}$, rated V_R		10	A	
				per leg		
				20		
Peak repetitive forward current per leg	I_{FRM}	Rated V_R , square wave, 20 kHz $T_C = 133\text{ }^\circ\text{C}$		20		
Non-repetitive peak surge current	I_{FSM}	5 μs sine or 3 μs rect. pulse	Following any rated load condition and with rated V_{RRM} applied	850		
		Surge applied at rated load conditions half wave, single phase, 60 Hz		150		
Peak repetitive reverse surge current	I_{RRM}	2.0 μs , 1.0 kHz		0.5		
Non-repetitive avalanche energy per leg	E_{AS}	$T_J = 25\text{ }^\circ\text{C}$, $I_{AS} = 2\text{ A}$, $L = 12\text{ mH}$		24	mJ	

ELECTRICAL SPECIFICATIONS					
PARAMETER	SYMBOL	TEST CONDITIONS		VALUES	UNITS
Maximum forward voltage drop	$V_{FM}^{(1)}$	10 A	$T_J = 25\text{ }^\circ\text{C}$	0.80	V
		20 A		0.95	
		10 A	$T_J = 125\text{ }^\circ\text{C}$	0.70	
		20 A		0.85	
Maximum instantaneous reverse current	$I_{RM}^{(1)}$	$T_J = 25\text{ }^\circ\text{C}$	Rated DC voltage	0.10	mA
		$T_J = 125\text{ }^\circ\text{C}$		6	
Threshold voltage	$V_{F(TO)}$	$T_J = T_J$ maximum		0.433	V
Forward slope resistance	r_t			15.8	m Ω
Maximum junction capacitance	C_T	$V_R = 5\text{ }V_{DC}$ (test signal range 100 kHz to 1 MHz) $25\text{ }^\circ\text{C}$		400	pF
Typical series inductance	L_S	Measured from top of terminal to mounting plane		8.0	nH
Maximum voltage rate of change	dV/dt	Rated V_R		10 000	V/ μs

Note

(1) Pulse width < 300 μs , duty cycle < 2 %



MBRB20...CTG, MBR20...CTG-1

Schottky Rectifier,
2 x 10 A

Vishay High Power Products

THERMAL - MECHANICAL SPECIFICATIONS				
PARAMETER	SYMBOL	TEST CONDITIONS	VALUES	UNITS
Maximum junction temperature range	T_J		- 65 to 150	°C
Maximum storage temperature range	T_{Stg}		- 65 to 175	
Maximum thermal resistance, junction to case per leg	R_{thJC}	DC operation	2.0	°C/W
Maximum thermal resistance, junction to ambient	R_{thJA}		50	
Approximate weight			2	g
			0.07	oz.
Mounting torque	minimum	Non-lubricated threads	6 (5)	kgf · cm (lbf · in)
	maximum		12 (10)	
Marking device	Case style D ² PAK		MBRB2080CTG	
			MBRB2090CTG	
			MBRB20100CTG	
	Case style TO-262		MBR2080CTG-1	
			MBR2090CTG-1	
			MBR20100CTG-1	

MBRB20...CTG, MBR20...CTG-1



Vishay High Power Products

Schottky Rectifier,
2 x 10 A

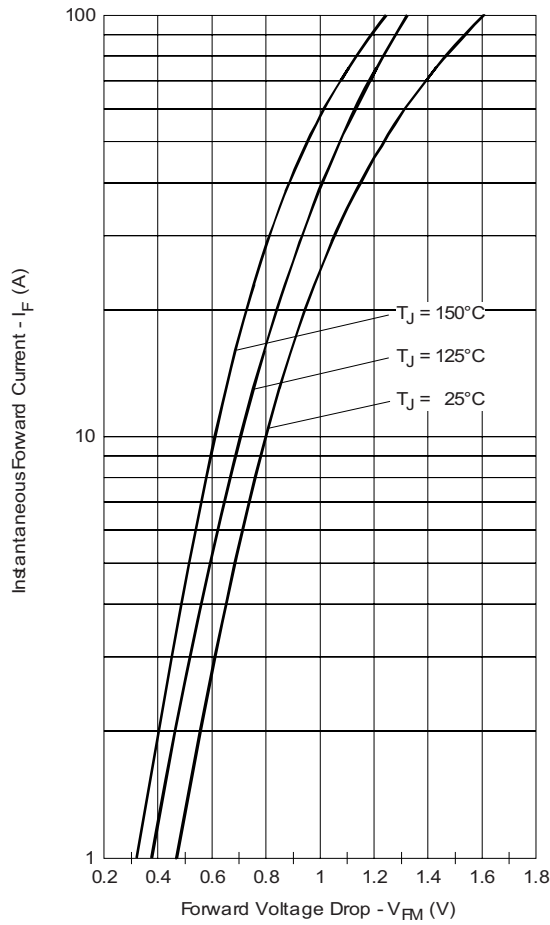

Fig. 1 - Maximum Forward Voltage Drop Characteristics (Per Leg)

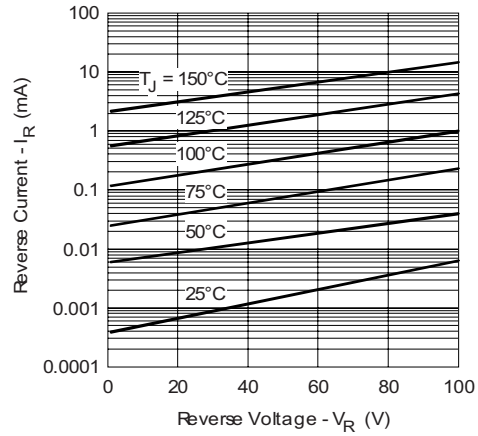

Fig. 2 - Typical Values of Reverse Current vs. Reverse Voltage (Per Leg)

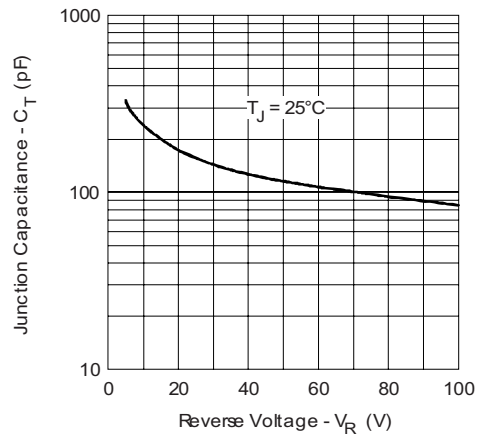

Fig. 3 - Typical Junction Capacitance vs. Reverse Voltage (Per Leg)

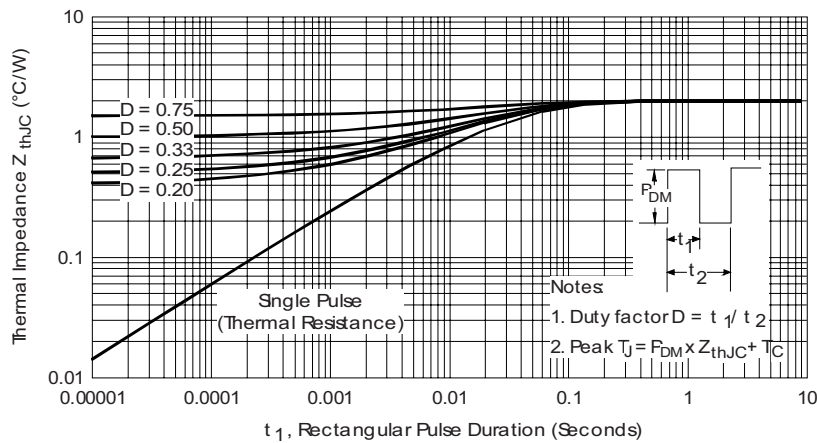

Fig. 4 - Maximum Thermal Impedance Z_{thJC} Characteristics (Per Leg)



MBRB20...CTG, MBR20...CTG-1

Schottky Rectifier,
2 x 10 A

Vishay High Power Products

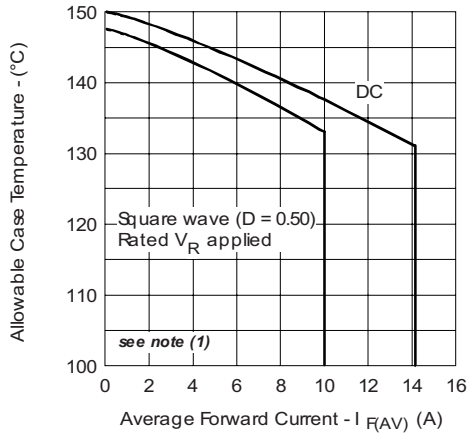

Fig. 5 - Maximum Allowable Case Temperature vs. Average Forward Current (Per Leg)

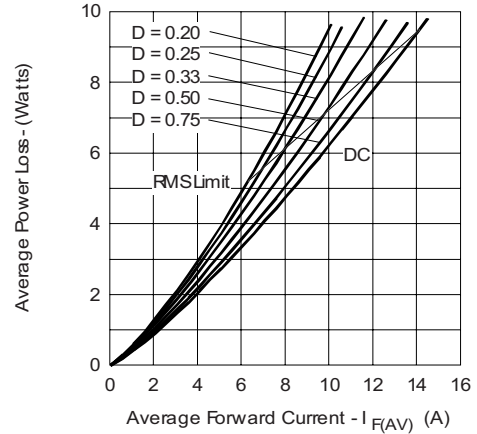

Fig. 6 - Forward Power Loss Characteristics (Per Leg)

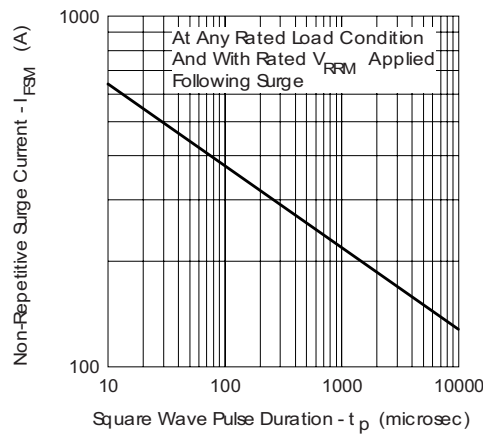

Fig. 7 - Maximum Non-Repetitive Surge Current (Per Leg)

Note

- (1) Formula used: $T_C = T_J - (P_d + P_{d_{REV}}) \times R_{thJC}$;
 P_d = Forward power loss = $I_{F(AV)} \times V_{FM}$ at $(I_{F(AV)}/D)$ (see fig. 6);
 $P_{d_{REV}}$ = Inverse power loss = $V_{R1} \times I_R (1 - D)$; I_R at V_{R1} = Rated V_R

MBRB20...CTG, MBR20...CTG-1

Vishay High Power Products

Schottky Rectifier,
2 x 10 A



ORDERING INFORMATION TABLE

Device code	MBR	B	20	100	CT	G	-1	TRL	-
	①	②	③	④	⑤	⑥	⑦	⑧	⑨

- 1** - Essential part number
- 2** -
 - B = D²PAK
 - None = TO-262
- 3** - Current rating (20 = 20 A)
- 4** - Voltage ratings
- 5** - CT = Essential part number
- 6** - G = Schottky generation
- 7** -
 - None = D²PAK
 - -1 = TO-262
- 8** -
 - None = Tube (50 pieces)
 - TRL = Tape and reel (left oriented - for D²PAK only)
 - TRR = Tape and reel (right oriented - for D²PAK only)
- 9** -
 - None = Standard production
 - PbF = Lead (Pb)-free (D²PAK tube)
 - P = Lead (Pb)-free (for D²PAK TRR and TRL, and TO-262)

80 = 80 V
90 = 90 V
100 = 100 V

LINKS TO RELATED DOCUMENTS	
Dimensions	http://www.vishay.com/doc?95014
Part marking information	http://www.vishay.com/doc?95057
Packaging information	http://www.vishay.com/doc?95032



Disclaimer

All product specifications and data are subject to change without notice.

Vishay Intertechnology, Inc., its affiliates, agents, and employees, and all persons acting on its or their behalf (collectively, "Vishay"), disclaim any and all liability for any errors, inaccuracies or incompleteness contained herein or in any other disclosure relating to any product.

Vishay disclaims any and all liability arising out of the use or application of any product described herein or of any information provided herein to the maximum extent permitted by law. The product specifications do not expand or otherwise modify Vishay's terms and conditions of purchase, including but not limited to the warranty expressed therein, which apply to these products.

No license, express or implied, by estoppel or otherwise, to any intellectual property rights is granted by this document or by any conduct of Vishay.

The products shown herein are not designed for use in medical, life-saving, or life-sustaining applications unless otherwise expressly indicated. Customers using or selling Vishay products not expressly indicated for use in such applications do so entirely at their own risk and agree to fully indemnify Vishay for any damages arising or resulting from such use or sale. Please contact authorized Vishay personnel to obtain written terms and conditions regarding products designed for such applications.

Product names and markings noted herein may be trademarks of their respective owners.