

PRELIMINARY SPEC

Features

- 0.8 INCH DIGIT HEIGHT.
- LOW CURRENT OPERATION.
- EXCELLENT CHARACTER APPEARANCE.
- I.C. COMPATIBLE.
- MECHANICALLY RUGGED.
- GRAY FACE, WHITE SEGMENT.
- PACKAGE : 200PCS / REEL.
- MOISTURE SENSITIVITY LEVEL : LEVEL 4.
- RoHS COMPLIANT.



ATTENTION
OBSERVE PRECAUTIONS
FOR HANDLING
ELECTROSTATIC
DISCHARGE
SENSITIVE
DEVICES

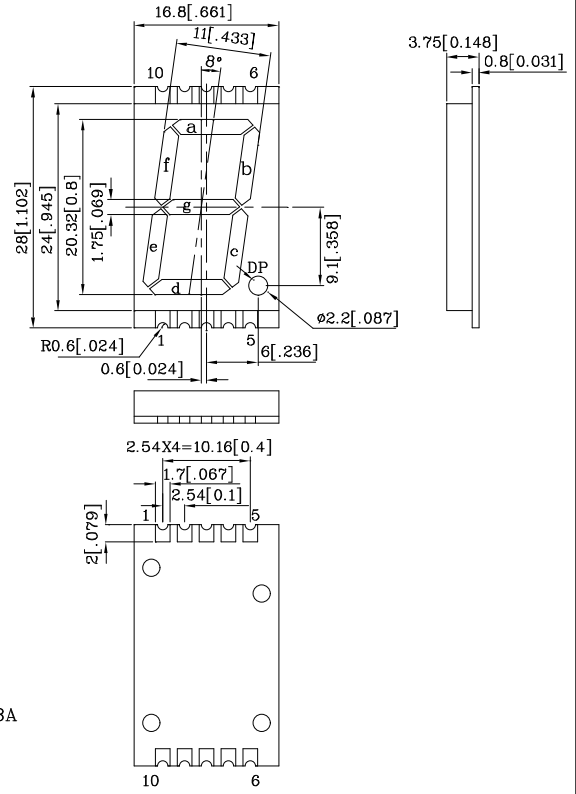
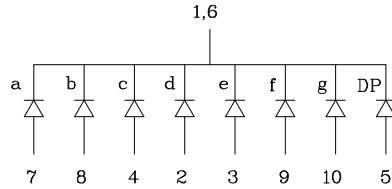

Notes:

1. All dimensions are in millimeters (inches).
2. Tolerance is $\pm 0.25(0.01)$ unless otherwise noted.
3. The gap between the reflector and PCB shall not exceed 0.25mm.
4. Specifications are subject to change without notice.

Absolute Maximum Ratings (TA=25°C)		BBA (InGaN)	Unit
Reverse Voltage	V _R	5	V
Forward Current	I _F	30	mA
Forward Current (Peak) 1/10 Duty Cycle 0.1ms Pulse Width	i _{FS}	100	mA
Power Dissipation	P _T	120	mW
Operating Temperature	T _A	-40 ~ +85	°C
Storage Temperature	T _{stg}	-40 ~ +85	
Electrostatic Discharge Threshold (HBM)		1000	V

Operating Characteristics (TA=25°C)		BBA (InGaN)	Unit
Forward Voltage (Typ.) (I _F =10mA)	V _F	3.05	V
Forward Voltage (Max.) (I _F =10mA)	V _F	4.0	V
Reverse Current (Max.) (V _R =5V)	I _R	10	uA
Wavelength of Peak Emission (Typ.) (I _F =10mA)	λ P	468	nm
Wavelength of Dominant Emission (Typ.) (I _F =10mA)	λ D	470	nm
Spectral Line Full Width At Half-Maximum (Typ.) (I _F =10mA)	Δλ	21	nm
Capacitance (Typ.) (V _F =0V, f=1MHz)	C	100	pF

Part Number	Emitting Color	Emitting Material	Luminous Intensity (I _F =10mA) ucd		Wavelength nm λ P	Description
			min.	typ.		
ZFBBA20C-A	Blue	InGaN	3000	11990	468	Common Cathode. Rt. Hand Decimal

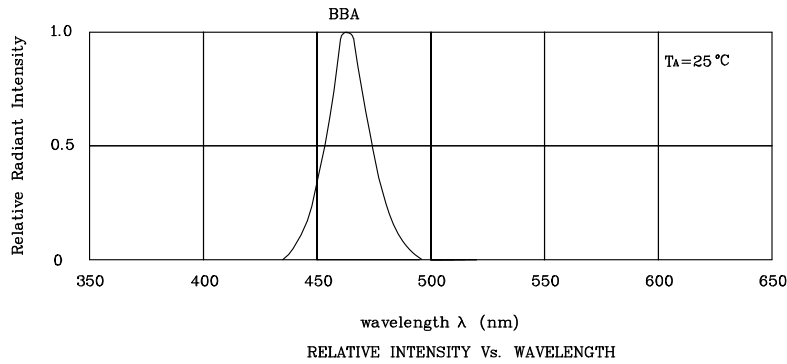

❖ BBA

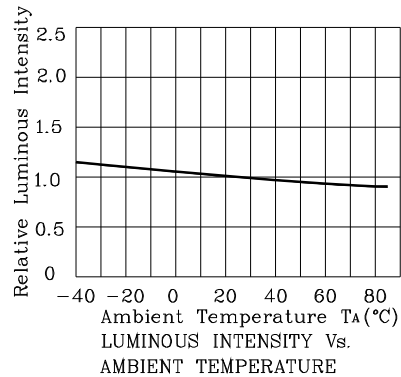
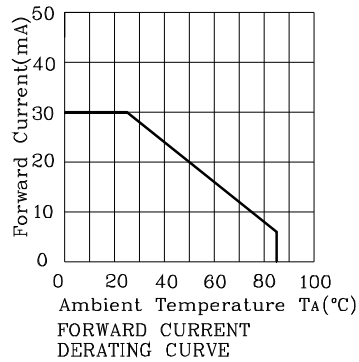
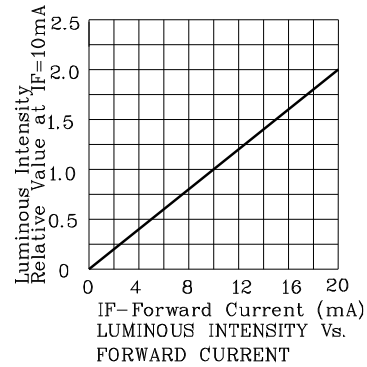
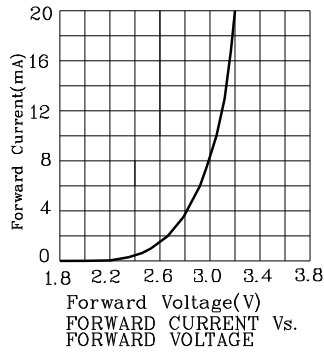

Remarks:

If special sorting is required (e.g. binning based on forward voltage, luminous intensity / luminous flux or wavelength), the typical accuracy of the sorting process is as follows:

1. Wavelength: +/-1nm
2. Luminous Intensity / Luminous Flux: +/-15%
3. Forward Voltage: +/-0.1V

Note: Accuracy may depend on the sorting parameters.

Reflow Soldering Profile For Lead-free SMT Process.

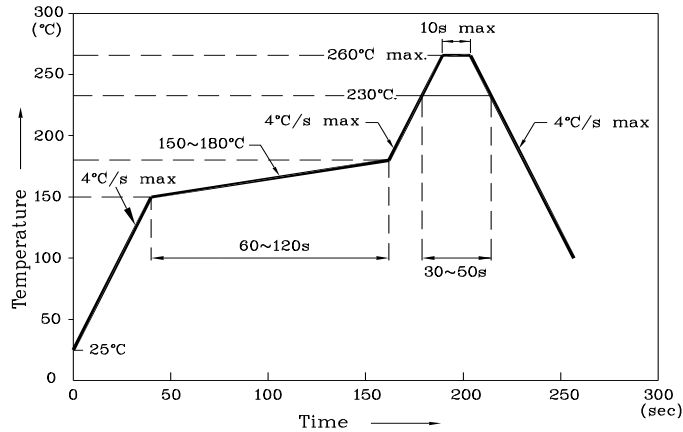

Notes:

1. Maximum soldering temperature should not exceed 260°C.
2. Recommended reflow temperature: 145°C-260°C.
3. Do not put stress to the epoxy resin during high temperatures conditions.

❖ Recommended Soldering Pattern (Units : mm;Tolerance:± 0.15)

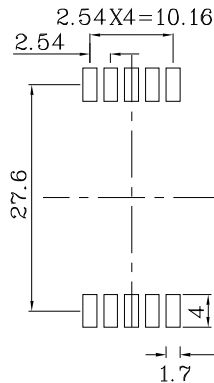

❖ Tape Specification (Units : mm)

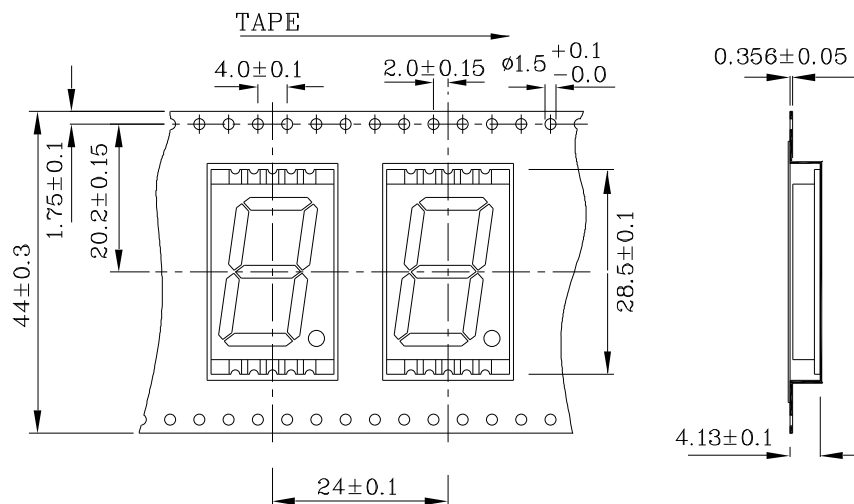

PACKING & LABEL SPECIFICATIONS

ZFBBA20C-A

