

BOOST CONTROLLER**AP3039****General Description**

AP3039 is a current mode high voltage low-side N-channel MOSFET controller which is ideal for boost regulators. It contains all the features needed to implement single ended primary topology DC/DC converters.

The input voltage range of AP3039 is from 6V to 27V. Its operation frequency is adjustable from 400K to 1MHz.

The AP3039 has UVLO (Under Voltage Lock Out) circuit. It uses two external resistors to set the UVLO voltage. The AP3039 also has an over output voltage protection to limit the output voltage. The OVP voltage can be set through external resistors. If the output voltage is higher than the OVP high threshold point, it will disable the driver, when the output voltage drops to the OVP low threshold point, it will enable the driver. It also features a soft start to reduce the inrush current when power on, the soft start time can be set through an external capacitor.

AP3039 is available in QFN-3x3-16 package.

Features

- Input Voltage Range 6V to 27V
- 0.6A Peak MOSFET Gate Driver
- 20ns Quick MOSFET Gate Driver
- Duty Cycle Limit of 90%
- Programmable UVLO
- Programmable Over Voltage Protection
- Cycle by Cycle Current Limit
- Adjustable Soft-Start
- Adjustable Operation Frequency from 400 kHz to 1 MHz

Applications

- Notebook
- LCD Display Modules

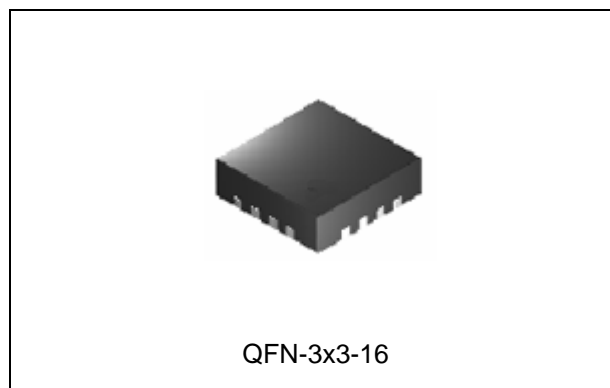

Figure 1. Package Type of AP3039

BOOST CONTROLLER
AP3039
Pin Configuration

Figure 2. Pin Configuration of AP3039 (Top View)

Pin Description

Pin Number	Pin Name	Function
1	EN	Enable pin
2	VIN	Input supply pin, must be locally bypassed
3, 12	NC	No connection
4	VCC	6V linear regulator output pin. VCC is used to bias the gate driver for the external MOSFET. If V_{IN} is less than 8.5V, the V_{CC} is equal to V_{IN} minus drop voltage across bypass switch. This pin should be bypassed to GND (recommend to connect with AGND pin) with a ceramic capacitor
5	OUT	Connect this pin to the gate of external MOSFET, the gate driver has 0.6A peak current capability
6	PGND	Power ground
7	RT	An external resistor connected from this pin to GND to set the operating frequency
8	CS	Sense switch current pin, which is used for current mode control and for current limit
9	AGND	Reference ground
10	SHDN	This pin can be connected to current matched chip and receives error signal used to shut down the system
11	FB	Voltage Feedback Pin. The reference voltage is 500mV
13	COMP	Compensation Pin. This pin is the output of the internal Error Amplifier

BOOST CONTROLLER
AP3039
Pin Description (Continued)

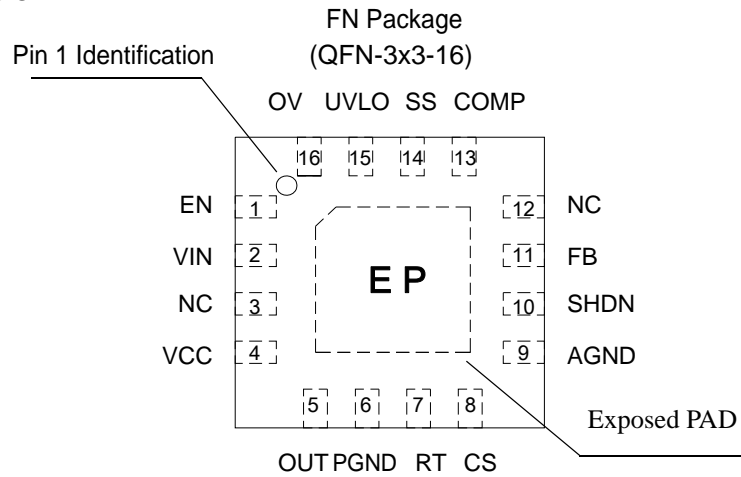
Pin Number	Pin Name	Function
14	SS	An external soft start time capacitor is connected from this pin to ground and is charged by internal $12\mu\text{A}$ current source to control regulator soft start time
15	UVLO	Two resistors connected from this pin to ground and the VIN pin respectively to set start up and shutdown level
16	OV	Over output voltage protection pin
	EP	Exposed backside pad. Solder to the circuit board ground plane with sufficient copper connection to ensure low thermal resistance

Functional Block Diagram

Figure 3. Functional Block Diagram of AP3039



BOOST CONTROLLER

AP3039

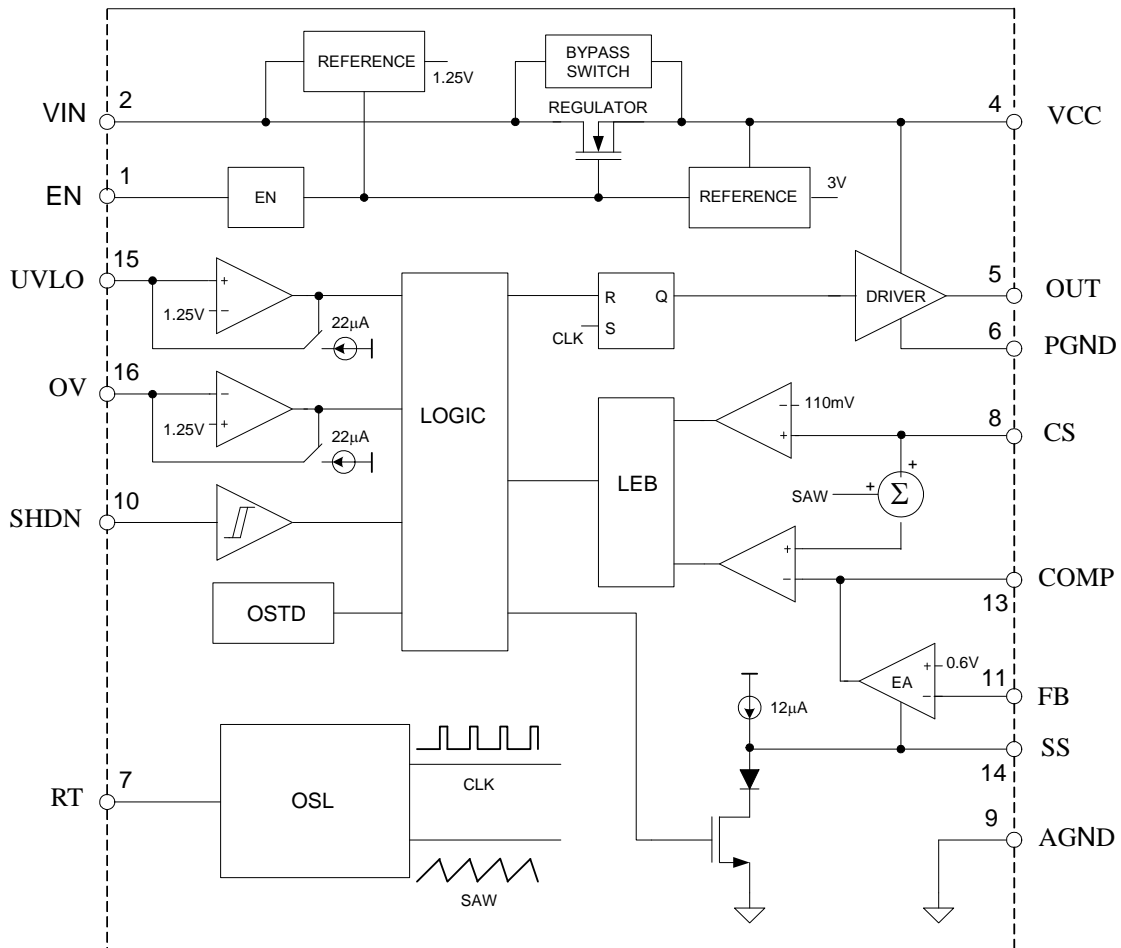
Ordering Information

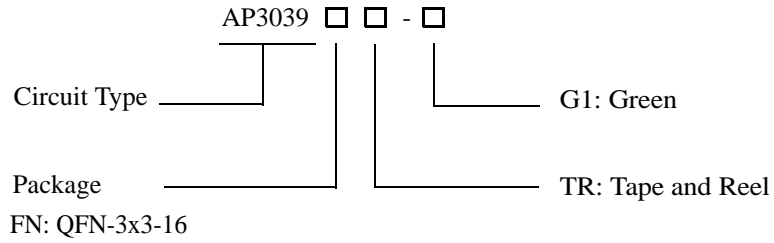

Package	Temperature Range	Part Number	Marking ID	Packing Type
QFN-3x3-16	-40 to 85°C	AP3039FNTR-G1	B2A	Tape & Reel

BCD Semiconductor's products, as designated with "G1" suffix in the part number, are RoHS compliant and Green.

**BOOST CONTROLLER****AP3039****Absolute Maximum Ratings (Note 1)**

Parameter	Symbol	Value	Unit
Input Voltage	V_{IN}	30	V
VCC Pin Voltage	V_{CC}	10	V
OUT Pin Voltage	V_{OUT}	10	V
Feedback Pin Voltage	V_{FB}	7	V
UVLO Pin Voltage	V_{UVLO}	7	V
CS Pin Voltage	V_{CS}	7	V
SHDN Pin Voltage	V_{SHDN}	7	V
Enable Pin Voltage	V_{EN}	V_{IN}	V
OV Pin Voltage	V_{OV}	7	V
Thermal Resistance (Junction to Ambient, no Heat sink)	$R_{\theta JA}$	60	°C/W
Operating Junction Temperature	T_J	150	°C
Storage Temperature Range	T_{STG}	-65 to 150	°C
Lead Temperature (Soldering, 10sec)	T_{LEAD}	260	°C
ESD (Machine Model)		200	V
ESD (Human Body Model)		2000	V

Note 1: Stresses greater than those listed under "Absolute Maximum Ratings" may cause permanent damage to the device. These are stress ratings only, and functional operation of the device at these or any other conditions beyond those indicated under "Recommended Operating Conditions" is not implied. Exposure to "Absolute Maximum Ratings" for extended periods may affect device reliability.

Recommended Operating Conditions

Parameter	Symbol	Min	Max	Unit
Input Voltage	V_{IN}	6	27	V
Operating Frequency	f	400	1000	kHz
Operating Temperature	T_A	-40	85	°C



BOOST CONTROLLER

AP3039

Electrical Characteristics

($V_{IN}=12V$, $V_{EN}=V_{IN}$, $T_A=25^{\circ}C$, unless otherwise specified.)

Parameter	Symbol	Conditions	Min	Typ	Max	Unit
Input Voltage	V_{IN}		6		27	V
Feedback Voltage	V_{FB}		470	500	530	mV
FB Pin Bias Current	I_{FB}			35	100	nA
Supply Current	I_{CC}	Not Switching		3	5	mA
Shutdown Supply Current	I_Q	$V_{EN}=0V$		1	2	μA
VCC Voltage	V_{CC}	$9V \leq V_{IN} \leq 27V$	5.5	6	6.5	V
		$6V \leq V_{IN} < 9V$	5			
VCC Current Limit	I_{CC-LIM}			50		mA
Drop Voltage Across Bypass Switch	$V_{IN}-V_{CC}$	$I_{CC}=0mA$, $f_{OSC} \leq 400kHz$, $6V \leq V_{IN} < 8.5V$		300		mV
Bypass Switch Turn-off Threshold	V_{BYP-HI}	V_{IN} increasing		8.7		V
Bypass Switch Threshold Hysteresis	$V_{BYP-HYS}$	V_{IN} decreasing		260		mV
VCC Pin UVLO Rising Threshold	V_{CC-HI}			4.7		V
VCC Pin UVLO Falling Hysteresis	V_{CC-HYS}			300		mV
Oscillator Frequency	f_{OSC}	Adjustable, $R_T=51k\Omega$ to $150k\Omega$	400		1000	kHz
UVLO Threshold	V_{UVLO}		1.22	1.25	1.28	V
UVLO Hysteresis Current Source	I_{HYS}			22		μA
Current Limit Threshold Voltage	V_{CS}		90	110	130	mV
RT Voltage	V_{RT}		1.20	1.25	1.30	V
Error Amplifier Transconductance	G_S			470		$\mu A/V$
EN Pin Threshold Voltage	V_{EH}		2.0			V
	V_{EL}				0.5	
SHDN Pin Threshold Voltage	V_{IH}		2.0			V
	V_{IL}				0.5	

**BOOST CONTROLLER****AP3039****Electrical Characteristics (Continued)** $(V_{IN}=12V, V_{EN}=V_{IN}, T_A=25^{\circ}C, \text{ unless otherwise specified.})$

Parameter	Symbol	Conditions	Min	Typ	Max	Unit
OV Threshold	V_{OV}			1.25		V
OV Hysteresis Current Source	I_{OV-HYS}			22		μA
Maximum Duty Cycle	D_{MAX}			90	93	%
Soft Start Current Source	I_{SS}			12		μA
Out Pin Rise Time	t_{RISE}	Out Pin Load = 1nF		20		ns
Out Pin Fall Time	t_{FALL}	Out Pin Load = 1nF		20		ns
OUT Dropout Voltage ($V_{CC}-V_{OUT}$)	V_{OUT-H}	$I_{OUT}=50mA$		0.25	0.75	V
OUT Low Voltage Level (V_{OUT})	V_{OUT-L}	$I_{OUT}=100mA$		0.25	0.75	V
Thermal Shutdown Temperature	T_{OTSD}			160		$^{\circ}C$
Thermal Shutdown Hysteresis	T_{HYS}			20		$^{\circ}C$



BOOST CONTROLLER

AP3039

Typical Performance Characteristics

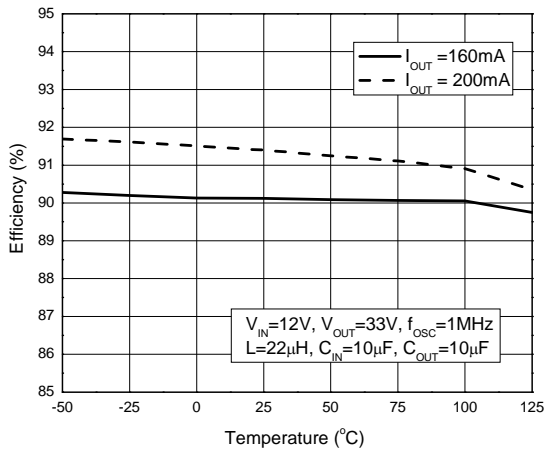

Figure 4. Efficiency vs. Case Temperature

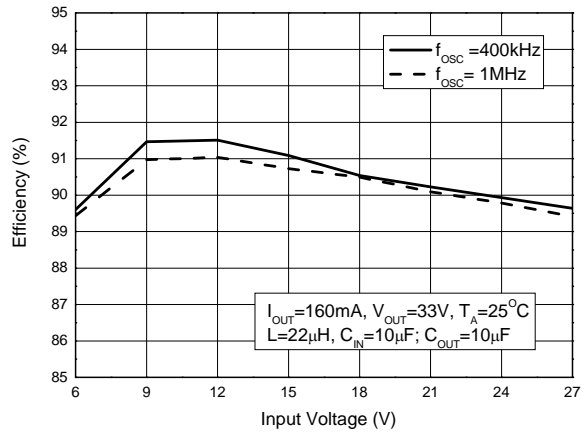

Figure 5. Efficiency vs. Input Voltage

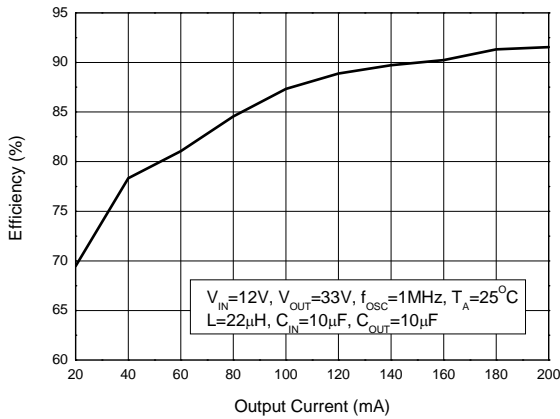

Figure 6. Efficiency vs. Output Current

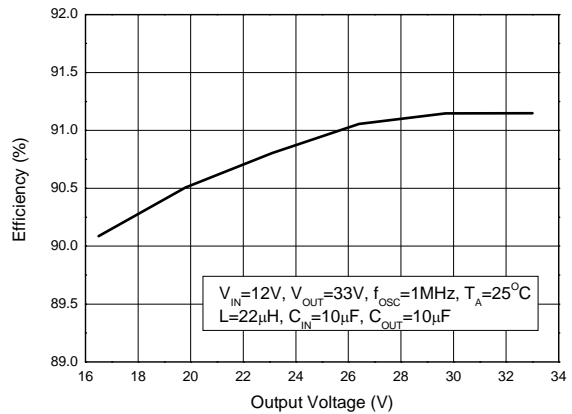

Figure 7. Efficiency vs. Output Voltage



Typical Performance Characteristics (Continued)

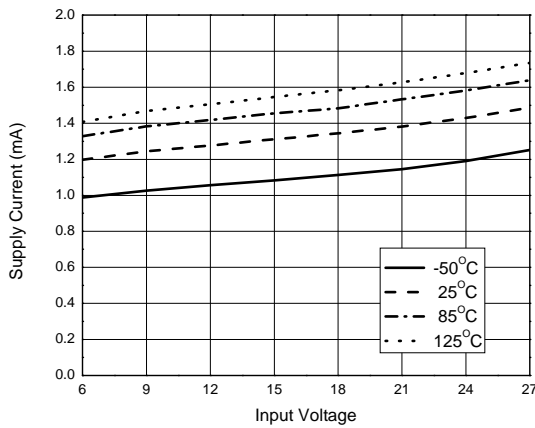

Figure 8. Supply Current vs. Input Voltage

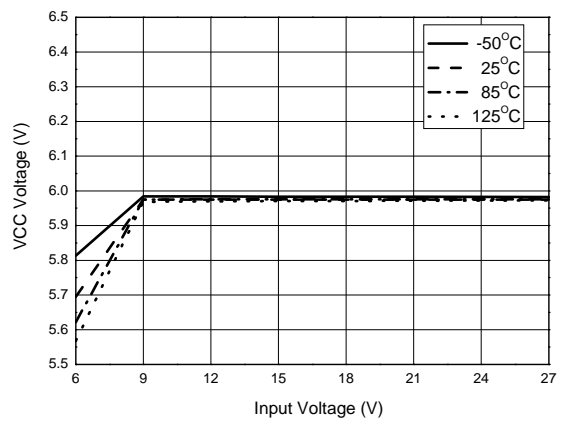

Figure 9. VCC Voltage vs. Input Voltage

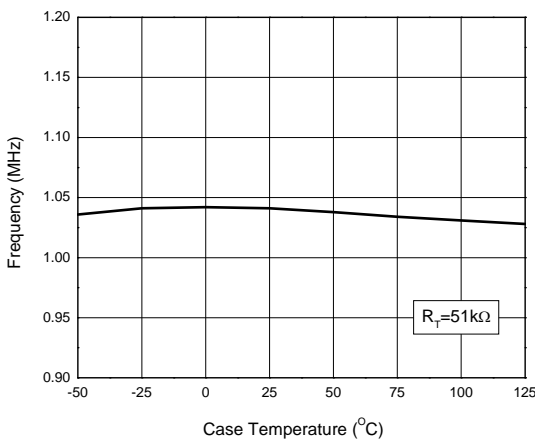

Figure 10. Switching Frequency vs. Case Temperature

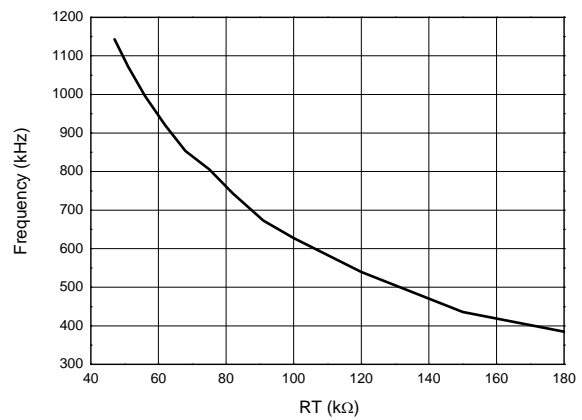

Figure 11. Switching Frequency vs. RT Value



Typical Performance Characteristics (Continued)

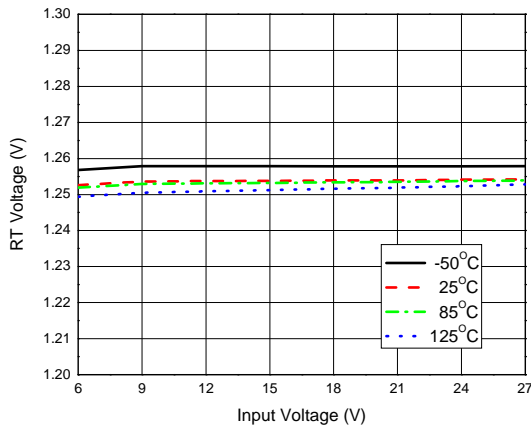

Figure 12. RT Voltage vs. Input Voltage

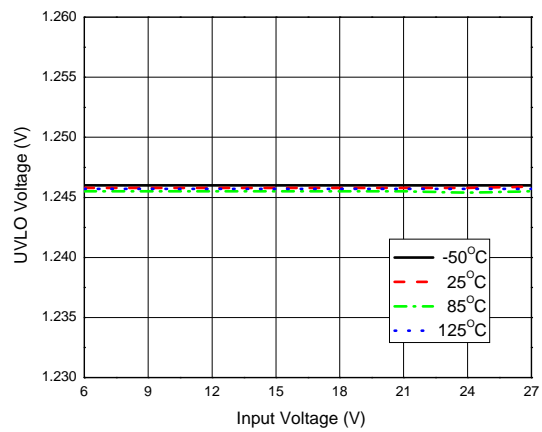

Figure 13. UVLO Voltage vs. Input Voltage

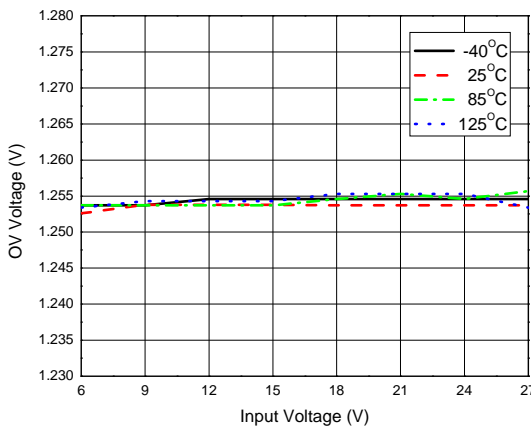

Figure 14. OV Voltage vs. Input Voltage

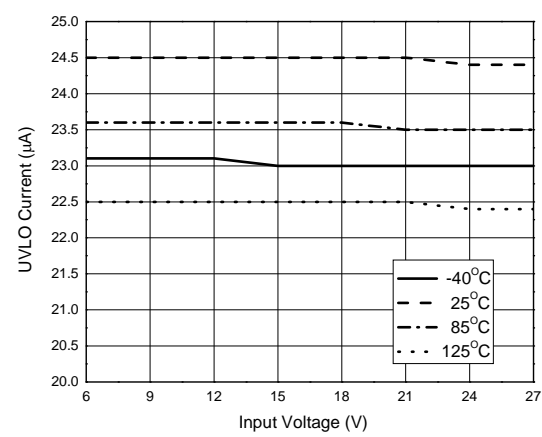

Figure 15. UVLO Current vs. Input Voltage



Typical Performance Characteristics (Continued)

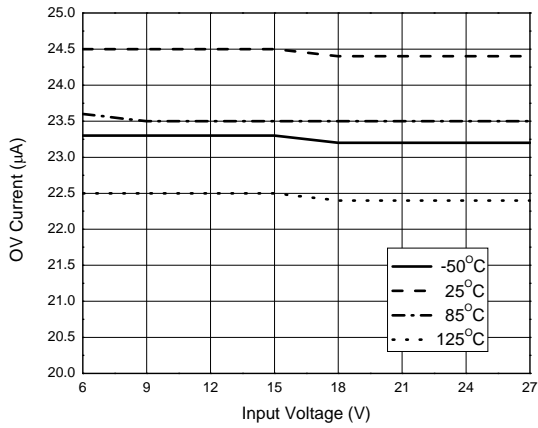

Figure 16. OV Current vs. Input Voltage

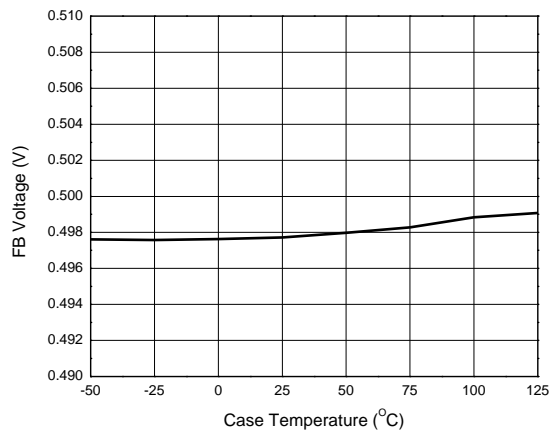

Figure 17. Feedback Voltage vs. Case Temperature

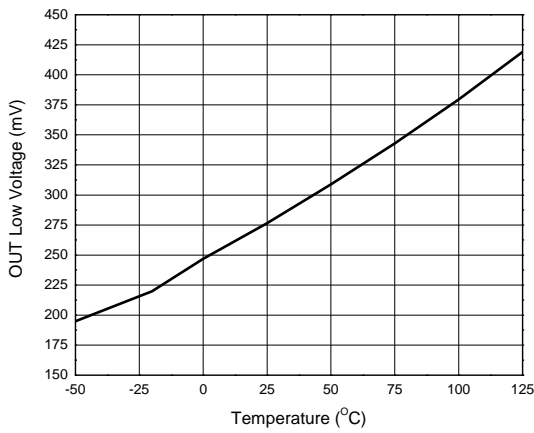

Figure 18. OUT Low Voltage vs. Case Temperature

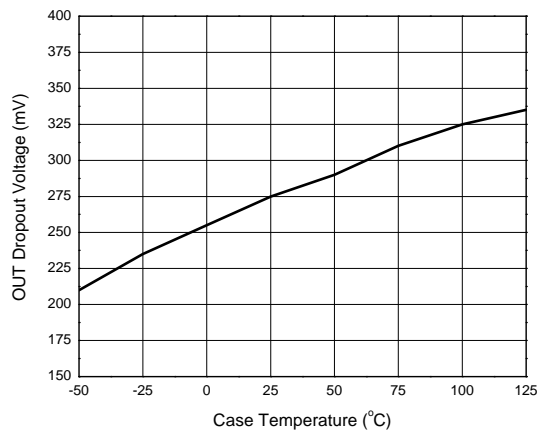

Figure 19. OUT Dropout Voltage vs. Case Temperature

**BOOST CONTROLLER****AP3039****Application Information
Operation**

AP3039 is a boost DC-DC controller with adjustable operation frequency. Current mode control scheme provides excellent line and load regulation. Operation can be best understood by referring to Figure 3.

At the start of each oscillator cycle, the SR latch is set and external power switch Q1 (see Figure 4) turns on and the switch current will increase linearly. The voltage on external sense resistor R_{CS} (see Figure 4), connected from CS pin to GND, is proportional to the switch current. This voltage is added to a stabilizing ramp and the result is fed into the non-inversion input of the PWM comparator. When this non-inversion input voltage exceeds inversion input voltage of PWM comparator which is the output voltage of the error amplifier EA, the SR latch is reset and the external power switch turns off. The voltage level at inversion input of PWM comparator sets the peak current level to keep the output voltage in regulation. This voltage level is the amplified signal of the voltage difference between feedback voltage and reference voltage of 0.5V. So, a constant output current can be provided by this operation mode.

Input Under-Voltage Detector

AP3039 contains an Under Voltage Lock Out (UVLO) circuit. Two resistors R1 and R2 are connected from UVLO pin to ground and VIN pin respectively (see Figure 4). The resistor divider must be designed such that the voltage on the UVLO pin is higher than 1.25V when VIN is in the desired operating range. If the voltage on the pin is below under voltage threshold, all functions of AP3039 are disabled, but the system will remain in a low power standby state. UVLO hysteresis is accomplished through an internal 22 μ A current source which switched on or off 22 μ A current into the impedance of the set-point divider. When the UVLO threshold is exceeded, the current source is activated to instantly raise the voltage on the UVLO pin. When the UVLO pin voltage falls below the threshold the current source is turned off, causing the voltage on the UVLO pin to fall. The formula for UVLO can be expressed as below:

For Input Threshold Voltage
 $V_{IN_THRESHOLD}=1.25V*(R1+R2)/R2$

For Input Hysteresis Voltage
 $V_{IN-HYSTERESIS}=22\mu A*R1$

Over Voltage Protection

AP3039 has an over voltage protection (OVP) circuit. The OV Pin is connected to the center tap of R3 and R4 resistor voltage-divider from the high voltage output to GND. (see Figure 21). When the loop is open or the output voltage becomes excessive in any case, result the voltage on OV pin exceeds 1.25V, all functions of AP3039 will be disabled, and the output voltage will fall. OVP hysteresis is accomplished with an internal 22 μ A current source and the operation mode is the same as UVLO. The formula for OVP can be expressed as below:

For OVP Voltage

$$V_{OVP}=1.25V*(R3+R4)/R4$$

For OVP Hysteresis Voltage

$$V_{OVP-HYSTERESIS}=22\mu A*R3$$

Frequency Selection

An external resistor R_T , connected from RT pin to GND, is used to set the operating frequency (see Figure 4). Operation frequency range is from 400kHz to 1MHz (see Table 1). High frequency operation optimizes the regulator for the smallest component size, while low frequency operation can reduce the switch losses.

Table 1. Frequency Selection

Resistance of R_T (k Ω)	Operating Frequency (kHz)
147	400
95	600
68	800
51	1000

Application Information (Continued)

Soft Start

AP3039 has a soft start circuit to limit the inrush current during startup. The time of soft start is controlled by an internal $12\mu\text{A}$ current source and an external soft start capacitor C_{SS} connected from SS pin to GND (see Figure 21). The effective C_{SS} voltage for Soft Start is from 0 to 2.3V, the time of Soft Start is:

$$t_{SS} = C_{SS} * 2.3V / 12\mu\text{A}$$

Typical Application

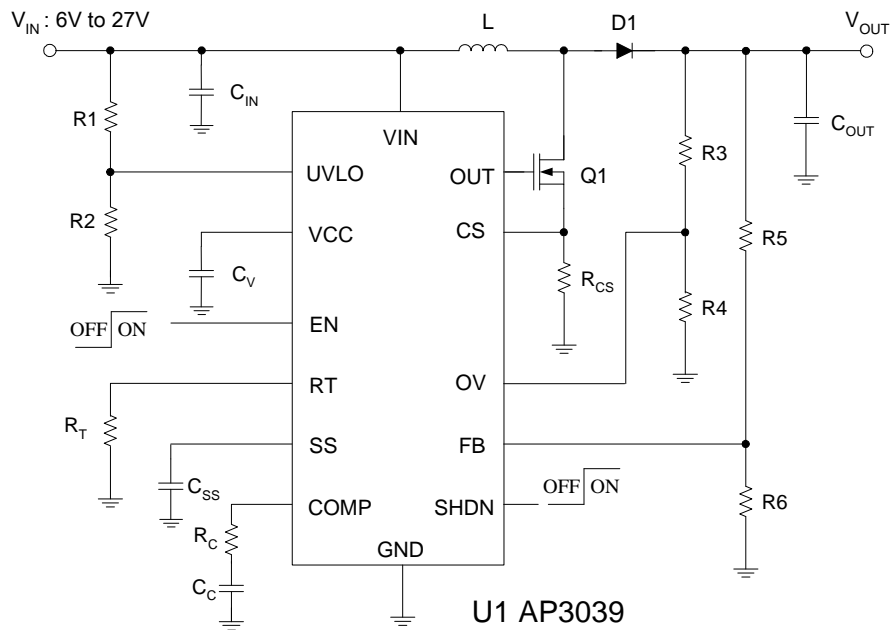

Figure 21. AP3039 Application Circuit



BOOST CONTROLLER

AP3039

Mechanical Dimensions

QFN-3x3-16

Unit: mm(inch)

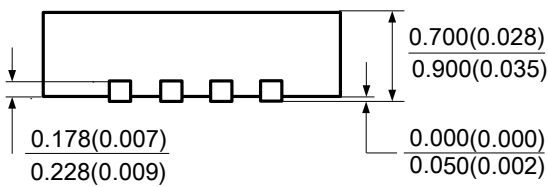
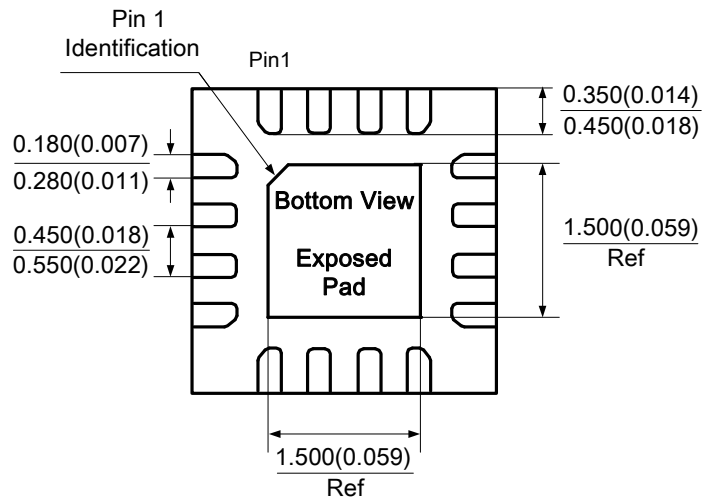
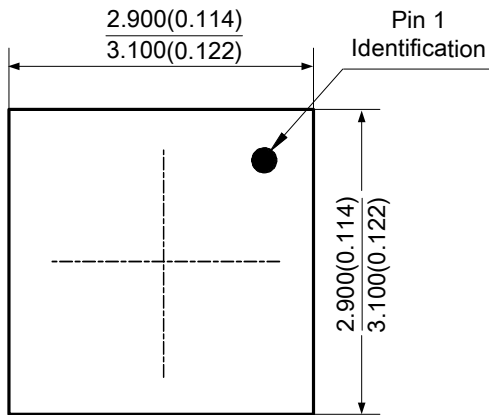



BCD Semiconductor Manufacturing Limited

<http://www.bcdsemi.com>

IMPORTANT NOTICE

BCD Semiconductor Manufacturing Limited reserves the right to make changes without further notice to any products or specifications herein. BCD Semiconductor Manufacturing Limited does not assume any responsibility for use of any its products for any particular purpose, nor does BCD Semiconductor Manufacturing Limited assume any liability arising out of the application or use of any its products or circuits. BCD Semiconductor Manufacturing Limited does not convey any license under its patent rights or other rights nor the rights of others.

MAIN SITE

- Headquarters

BCD Semiconductor Manufacturing Limited

No. 1600, Zi Xing Road, Shanghai Zizhu Science-based Industrial Park, 200241, China
Tel: +86-21-24162266, Fax: +86-21-24162277

- Wafer Fab

Shanghai SIM-BCD Semiconductor Manufacturing Co., Ltd.

800 Yi Shan Road, Shanghai 200233, China
Tel: +86-21-6485 1491, Fax: +86-21-5450 0008

REGIONAL SALES OFFICE

Shenzhen Office

Shanghai SIM-BCD Semiconductor Manufacturing Co., Ltd., Shenzhen Office
Room E, 5F, Noble Center, No.1006, 3rd Fuzhong Road, Futian District, Shenzhen,
518026, China
Tel: +86-755-8826 7951
Fax: +86-755-8826 7865

Taiwan Office

BCD Semiconductor (Taiwan) Company Limited
4F, 298-1, Rui Guang Road, Nei-Hu District, Taipei,
Taiwan
Tel: +886-2-2656 2808
Fax: +886-2-2656 2806

USA Office

BCD Semiconductor Corp.
30920 Huntwood Ave. Hayward,
CA 94544, USA
Tel : +1-510-324-2988
Fax: +1-510-324-2788