

Features

- Surface Mount
- 2 Way 0 degree
- 260°C Reflow Compatible
- RoHS* Compliant
- Available on Tape and Reel.

Description

M/A-COM's MAPDCT0029 is 2 way 0 degree RF power divider in a low cost, surface mount package. A 160 Ohm resistor included on the component. Ideally suited for high volume CATV/Broadband applications.

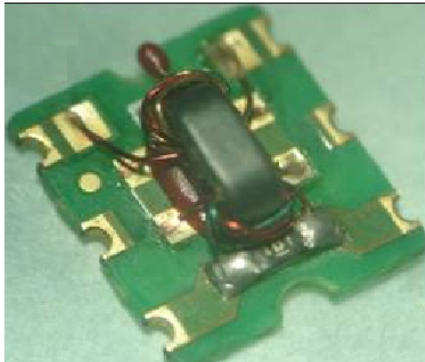

Functional Block Diagram

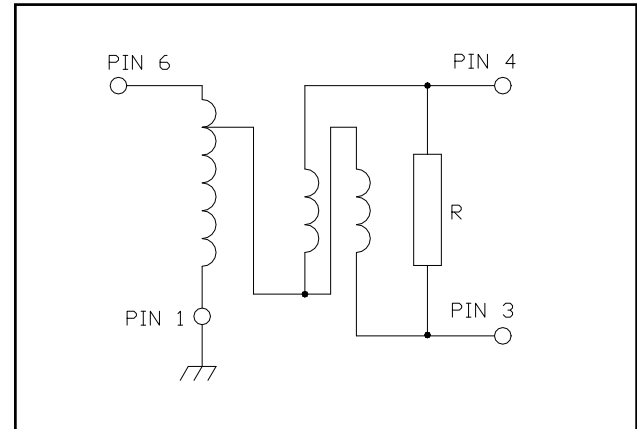

Pin Configuration

Pin No.	Function
1	Ground
2	Not connected (ground)
3	Output 2
4	Output 1
5	Not connected (ground)
6	Input

Ordering Information

Part Number	Package
MAPDCT0029TR	900 piece reel

Reference Application Note M513 for reel size information.

Absolute Maximum Ratings ^{1,2}

Parameter	Absolute Maximum
Max Input Power	1W
DC current	240mA
Operating Temperature	-40°C to +85°C
Storage Temperature	-55°C to +100°C

1. Exceeding any one or combination of these limits may cause permanent damage to this device.
2. M/A-COM does not recommend sustained operation near these survivability limits.

* Restrictions on Hazardous Substances, European Union Directive 2002/95/EC.

2 Way 0° Power Divider 5-1000MHz

Released Rev. V2

Electrical Specifications: $T_A = 25^\circ\text{C}$, $Z_0 = 75\Omega$ ¹

Parameter	Test Conditions	Frequency	Units	Min	Typ	Max
Insertion Loss	-	5 - 500 MHz	dB	-	0.5	0.7
Insertion Loss	-	500 - 1000 MHz	dB	-	0.7	1.4
Amplitude Unbalance (Nominal 0dB)	-	5 - 1000 MHz	dB	-	± 0.28	± 0.55
Phase Unbalance (Nominal 0°)	-	5 - 1000 MHz	°	-	± 1.0	± 3.0
Return Loss: Input	-	5 - 50 MHz	dB	24	35	-
Return Loss: Input	-	50 - 870 MHz	dB	14	26	-
Return Loss: Input	-	870 - 1000 MHz	dB	11	16	-
Return Loss: Output	-	5 - 1000 MHz	dB	15	22.5	-
Isolation (between outputs)	-	5 - 50 MHz	dB	20	26	-
Isolation (between outputs)	-	50 - 870 MHz	dB	14	22	-
Isolation (between outputs)	-	870 - 1000 MHz	dB	12	15	-

Case Style: SM-55

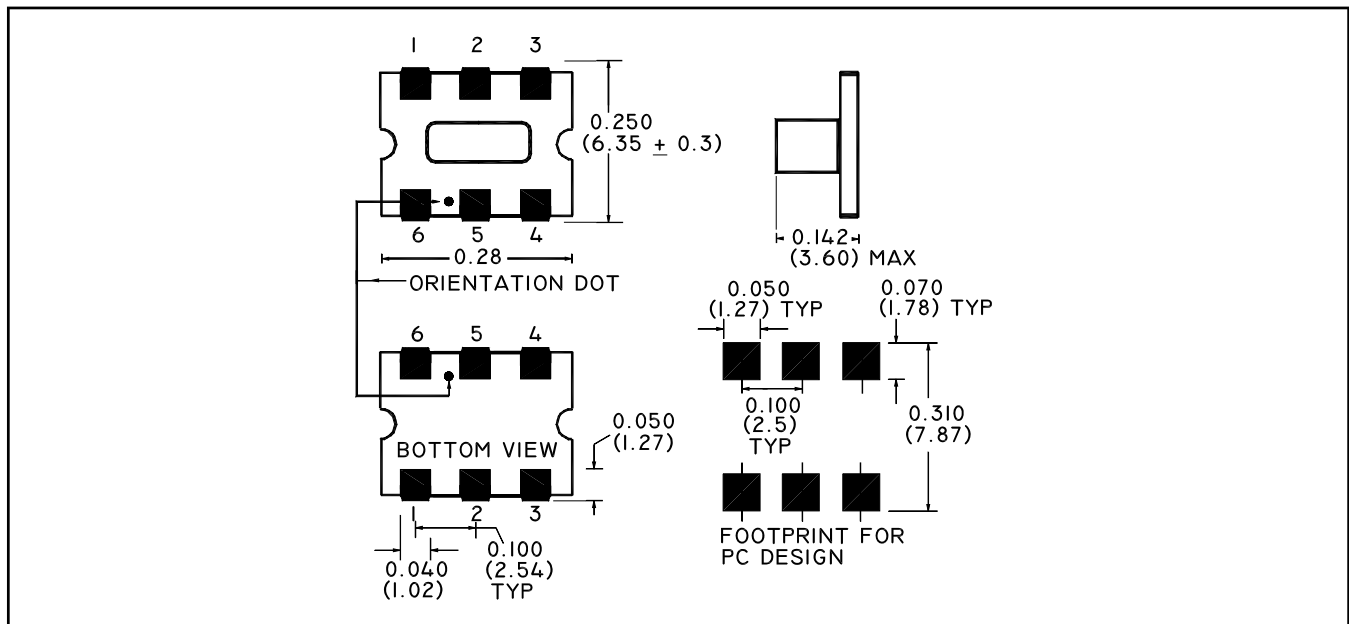

Typical Performance Curves: $T_A = 25^\circ\text{C}$, $Z_0 = 75\Omega$ ¹

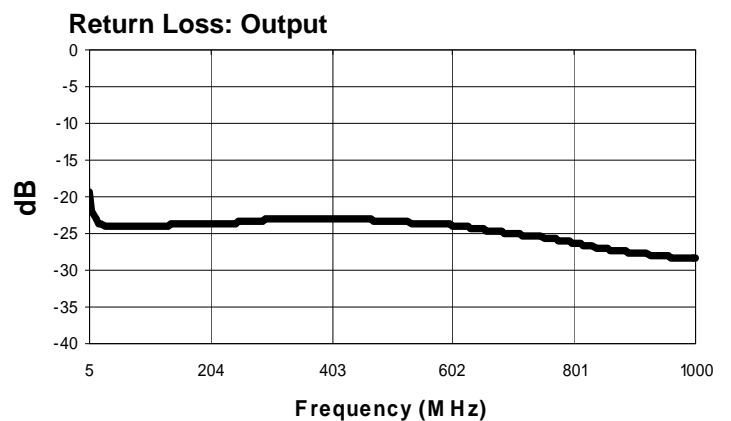
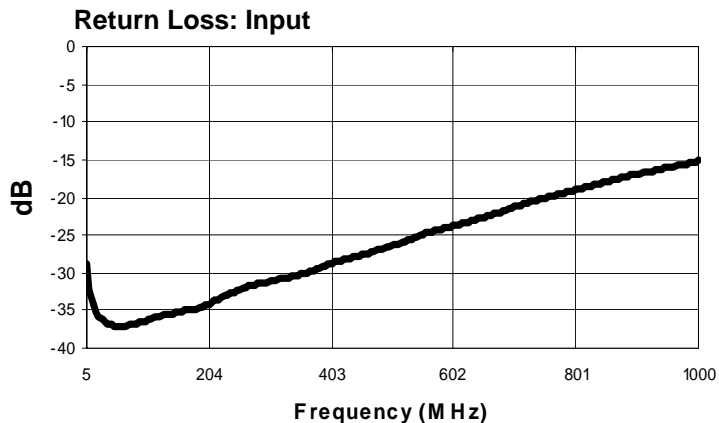
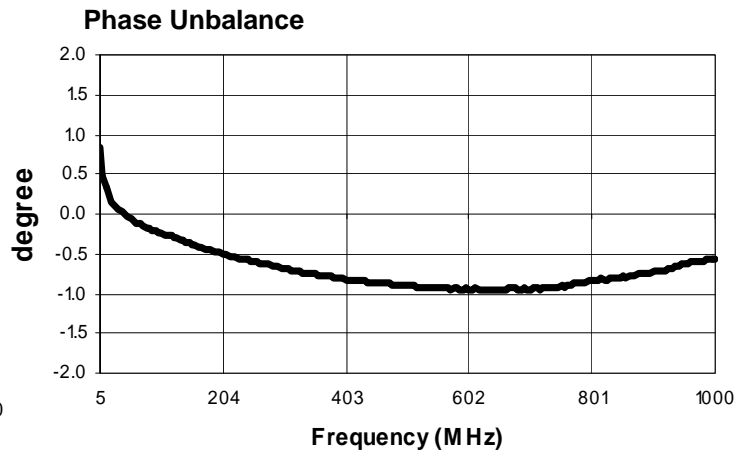
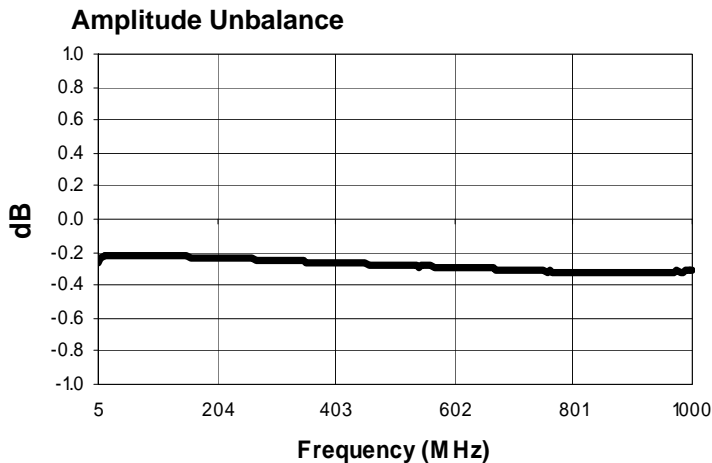
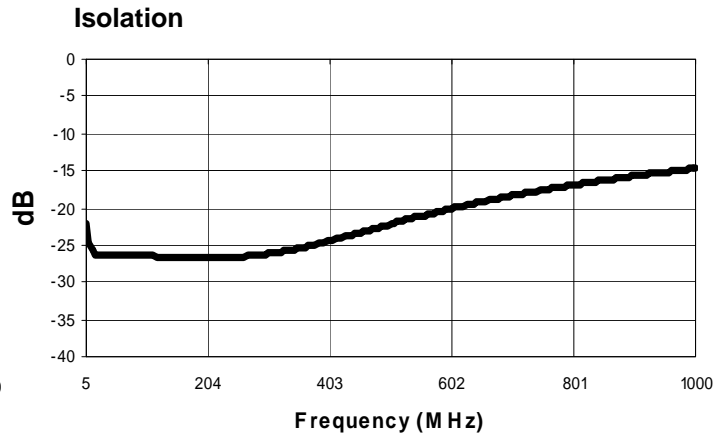
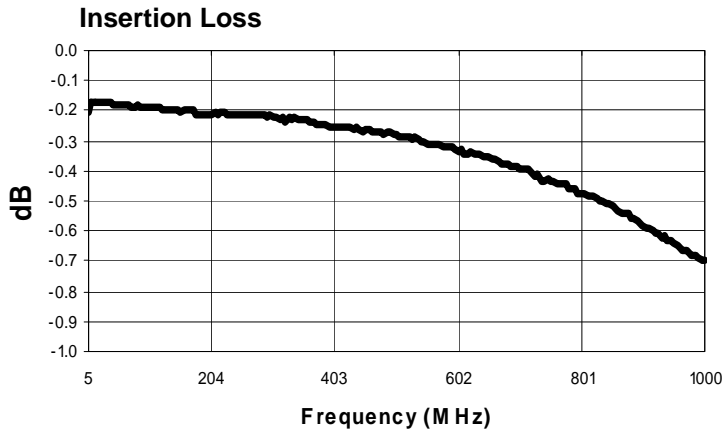

ADVANCED: Data Sheets contain information regarding a product M/A-COM Technology Solutions is considering for development. Performance is based on target specifications, simulated results, and/or prototype measurements. Commitment to develop is not guaranteed.

PRELIMINARY: Data Sheets contain information regarding a product M/A-COM Technology Solutions has under development. Performance is based on engineering tests. Specifications are typical. Mechanical outline has been fixed. Engineering samples and/or test data may be available. Commitment to produce in volume is not guaranteed.

• North America Tel: 800.366.2266 • Europe Tel: +353.21.244.6400
• India Tel: +91.80.4155721 • China Tel: +86.21.2407.1588

Visit www.macomtech.com for additional data sheets and product information.

M/A-COM Technology Solutions Inc. and its affiliates reserve the right to make changes to the product(s) or information contained herein without notice.