

PAN202U / PANP202U / PAN217U

SURFACE MOUNT SWITCHING DIODES

SWITCHING DIODE 100m AMPERRES 80 VOLTS

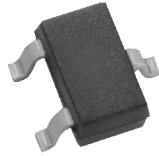

SOT-323(SC-70)

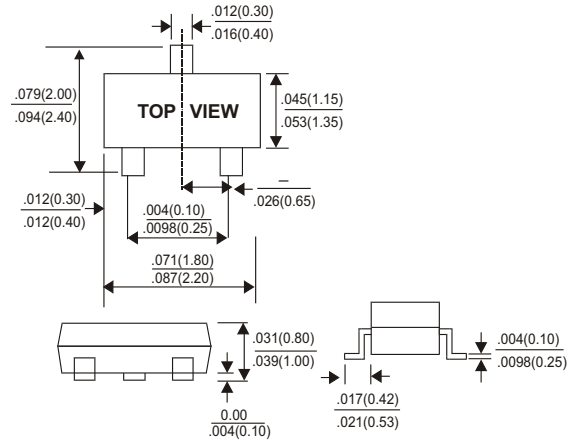

FEATURES

- Low Current Leakage
- Low Forward Voltage
- Ultra High Speed Switching
- Surface Mount Package Ideally Suited for Automatic Insertion

MECHANICAL DATA

- Case SOT-323, Molded Plastic
- Terminal Solderable per MIL-STD-202 Method 20
- Polarity See Diagram
- Weight 0.006grams (approx)

MAXIMUM RATING (EACH DIODE)

Characteristic	Symbol	PAN202U	PANP202U	PAN217U	Unit
Reverse Voltage	V_R	80			Volts
Forward Current	$I_{F(AV)}$	100			mA
Peak Forward Surge Current	I_{FSM}	300			mA

THERMAL CHARACTERISTICS

Characteristic	Symbol	Max	Unit
Total Device Dissipation FR-5 Board *1, $T_A = 25^\circ\text{C}$ Derate Above 25°C	PD	200 1.6	mW mW/ $^\circ\text{C}$
Thermal Resistance Junction to Ambient	$R_{\theta JA}$	625	$^\circ\text{C} / \text{W}$
Junction and Storage Temperature	T_J, T_{stg}	-55 to +150	$^\circ\text{C}$

*1 ER-5=1.0x0.75x0.062 in

PAN202U / PANP202U / PAN217U



SURFACE MOUNT SWITCHING DIODES

SWITCHING DIODE 100m AMPERRES 80 VOLTS

ELECTRICAL CHARACTERISTICS (T_A=25°C unless otherwise noted)

Characteristic	Symbol	Min	Max	Unit
Reverse Breakdown Voltage (I _R = 100 μA)	V _{(BR)R}	80	–	Volts
Reverse Voltage Leakage Current V _R =70V	I _R	–	0.1	μA _{dc}
Diode Capacitance(V _R =6VDC, f=1.0MHz)	C _D	–	3.5	pF
Forward Voltage I _F = 100mA _{dc}	V _F	–	1.2	V _{dc}
Reverse Recovery Time(Figure1.) I _R = 5.0mA _{dc} , V _R = 6.0V _{dc}	t _{rr}	–	4.0	nS

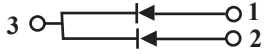
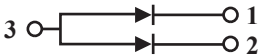
DEVICE MARKING

Item	Marking	Equivalent Circuit diagram
P AN202U	MU	
P AP202U	MO	
P AN217U	A7	

PAN202U / PANP202U / PAN217U

SURFACE MOUNT SWITCHING DIODES

SWITCHING DIODE 100m AMPERRES 80 VOLTS

FIG 1. Recovery Time Equivalent Test Circuit

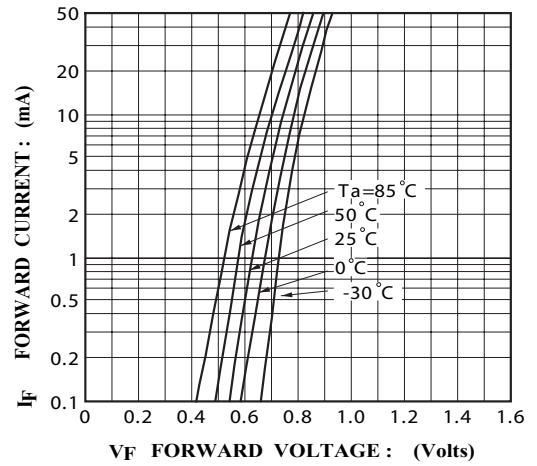
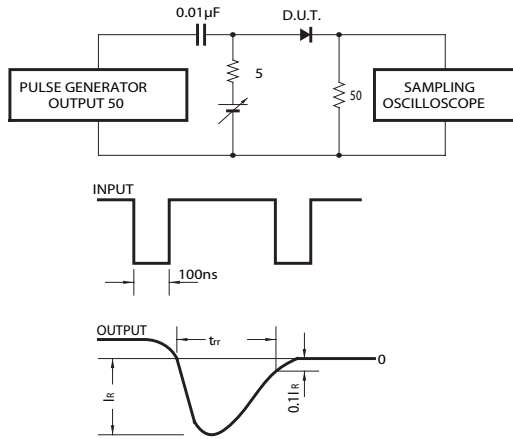

FIG.2 Forward characteristics

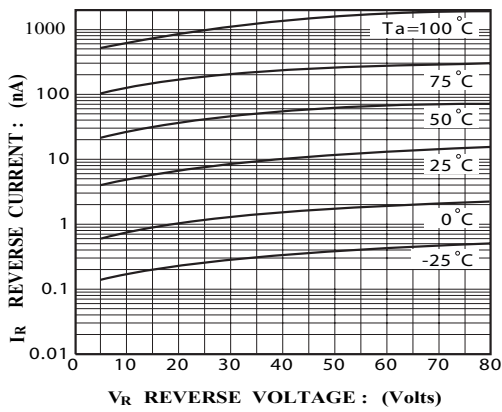

FIG.3 Reverse characteristics

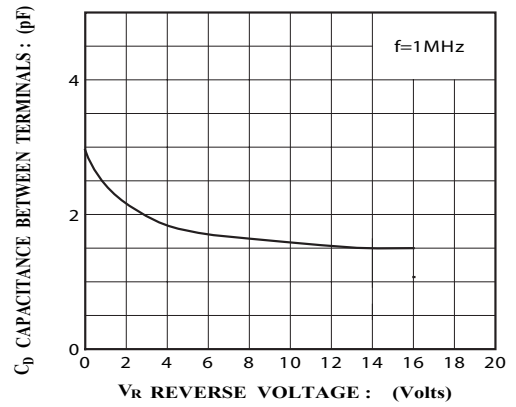

FIG.4 Capacitance