

Silicon PNP Power Transistors

2SA1295

DESCRIPTION

- With MT-200 package
- Complement to type 2SC3264

APPLICATIONS

- Audio and general purpose applications

PINNING (see Fig.2)

PIN	DESCRIPTION
1	Base
2	Collector;connected to mounting base
3	Emitter

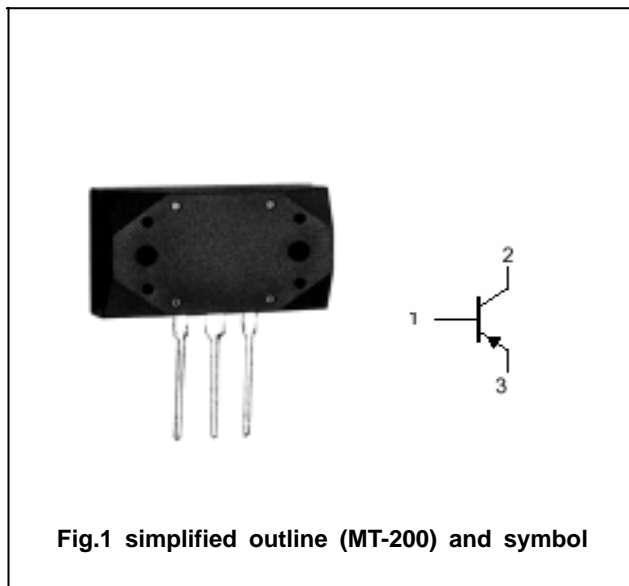

Fig.1 simplified outline (MT-200) and symbol

Absolute maximum ratings(Ta=25)

SYMBOL	PARAMETER	CONDITIONS	VALUE	UNIT
V _{CBO}	Collector-base voltage	Open emitter	-230	V
V _{CEO}	Collector-emitter voltage	Open base	-230	V
V _{EBO}	Emitter-base voltage	Open collector	-5	V
I _C	Collector current		-17	A
I _B	Base current		-5	A
P _C	Collector power dissipation	T _C =25	200	W
T _j	Junction temperature		150	
T _{stg}	Storage temperature		-55~150	

Silicon PNP Power Transistors

2SA1295

CHARACTERISTICS

T_j=25 unless otherwise specified

SYMBOL	PARAMETER	CONDITIONS	MIN	TYP.	MAX	UNIT
V _{(BR)CEO}	Collector-emitter breakdown voltage	I _C =-25mA ; I _B =0	-230			V
V _{CEsat}	Collector-emitter saturation voltage	I _C =-5A ; I _B =-0.5A			-2.0	V
I _{CBO}	Collector cut-off current	V _{CB} =-230V; I _E =0			-100	μA
I _{EBO}	Emitter cut-off current	V _{EB} =-5V; I _C =0			-100	μA
h _{FE}	DC current gain	I _C =-5A ; V _{CE} =-4V	50		140	
C _{ob}	Output capacitance	I _E =0 ; V _{CB} =-10V;f=1MHz		500		pF
f _T	Transition frequency	I _C =-2A ; V _{CE} =-12V		35		MHz

Switching times

t _{on}	Turn-on time	I _C =-5A;R _L =12 I _{B1} =-I _{B2} =-0.5A V _{CC} =-60V		0.35		μs
t _s	Storage time			1.50		μs
t _f	Fall time			0.30		μs

◆ h_{FE} classifications

O	Y
50-100	70-140

Silicon PNP Power Transistors

2SA1295

PACKAGE OUTLINE

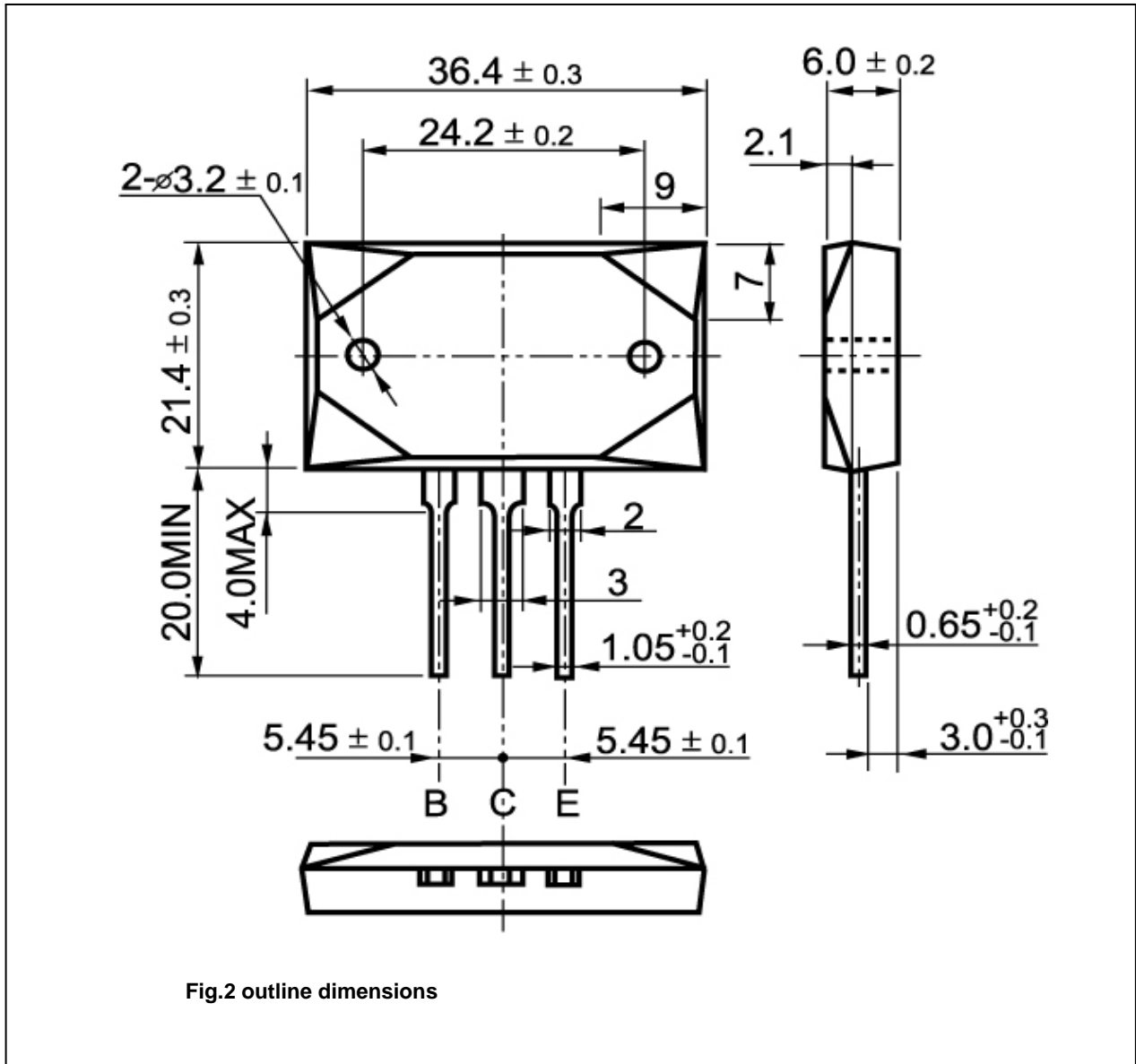

Fig.2 outline dimensions

Silicon PNP Power Transistors

2SA1295

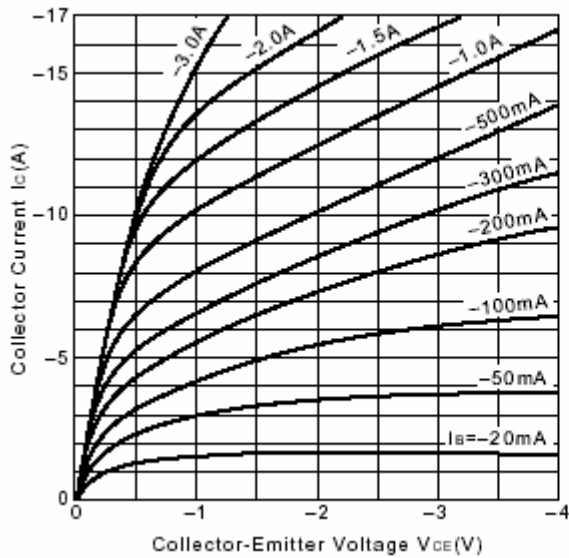

Fig.3 Static Characteristic

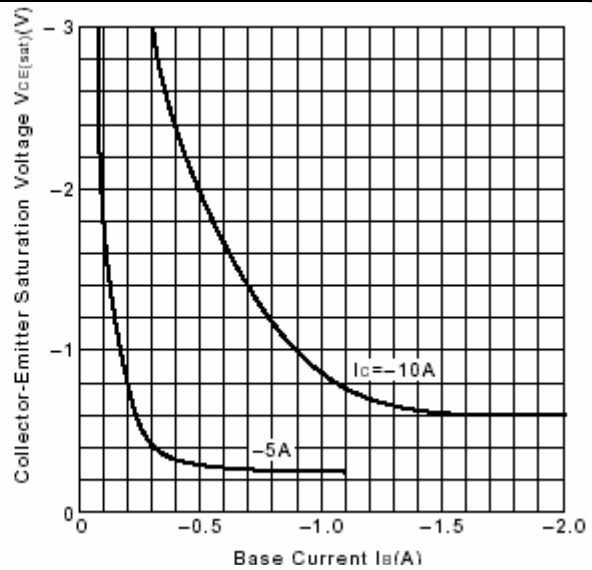

Fig.4 $V_{CE(sat)}-I_B$ Characteristics

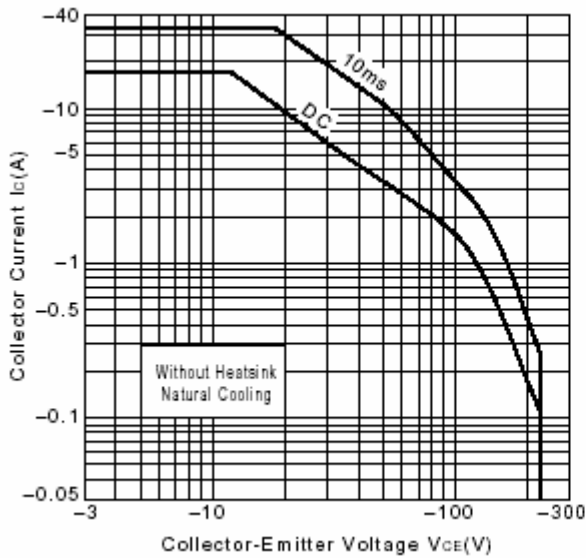

Fig.5 Safe Operating Area

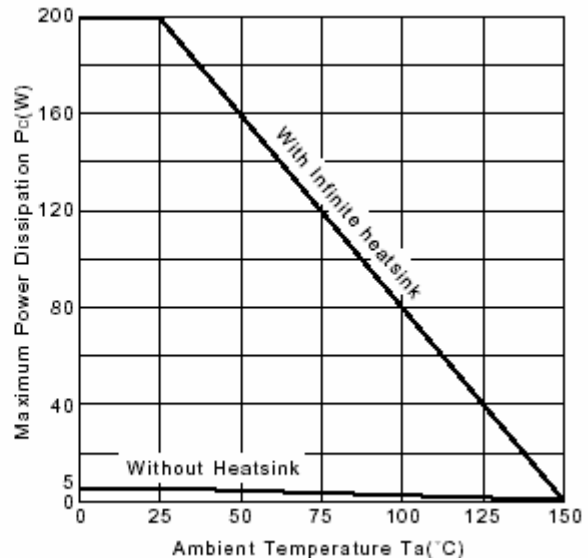

Fig.6 P_c-T_a Derating

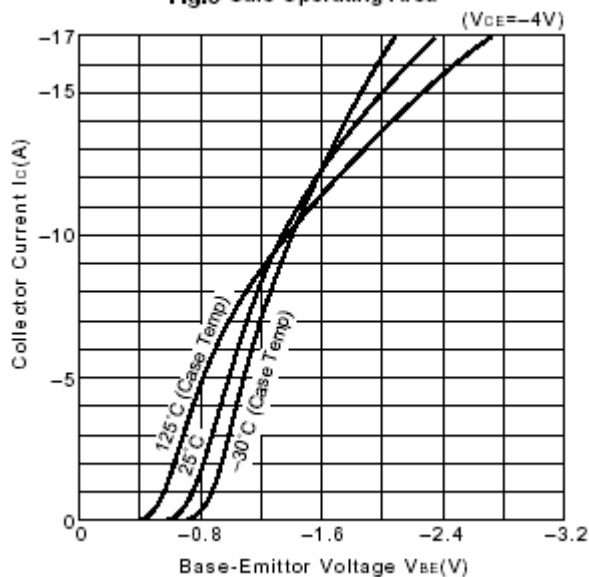

Fig.7 I_c-V_{BE}

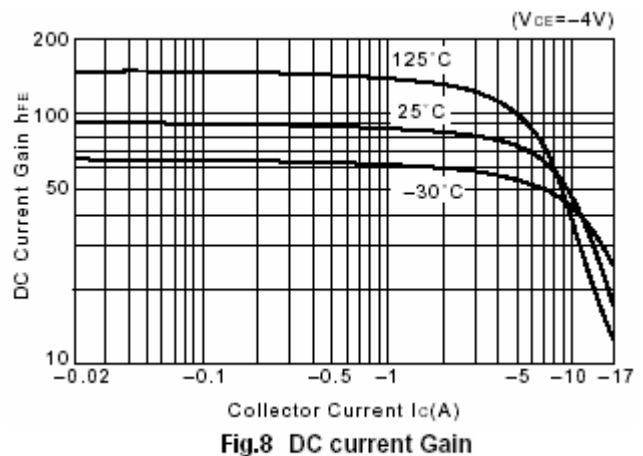

Fig.8 DC current Gain