

Powered by



# HR 1224W ▶ 12V 24W

HR 1224W is specially designed for high efficient discharge application. Its characteristics are high energy density, small footprint and high discharge efficiency. It can be used for more than 260 cycles at 100% discharge in cycle service, up to 5 years in standby service.



## ► Specification

Cells Per Unit	6
Voltage Per Unit	12
Capacity	24W @ 15min-rate to 1.67V per cell @25 °C(77°F) 6 Ah @ 20hr-rate to 1.75V per cell @25 °C(77°F)
Weight	Approx. 1.95 kg(4.3 lbs)
Maximum Discharge Current	100A/130A(5sec)
Internal Resistance	Approx. 21 mΩ
Operating Temperature Range	Discharge: -15°C~50°C ( 5°F~122°F) Charge: -15 °C~40°C ( 5°F~104°F) Storage: -15°C~40°C ( 5°F~104°F)
Nominal Operating Temperature Range	25°C±3°C(77°F±5°F)
Float Charging Voltage	13.5 to 13.8 VDC/unit Average at 25°C(77°F)
Recommended Maximum Charging Current Limit	2.4A
Equalization and Cycle Service	14.4 to 15.0 VDC/unit Average at 25°C(77°F)
Self Discharge	CSB Batteries can be stored for more than 6 months at 25°C(77°F). Please charge batteries before using. For higher temperatures the time interval will be shorter.
Terminal	F1/F2-Faston Tab187/250
Container Material	ABS(UL 94-HB/File E50263)*Flammability resistance of (UL 94-V0/File E88637) can be available upon request.



MH14533(N)



ISO9001  
No.:041005117



ISO 14001  
NO.UM 1-12-0045

CSB-manufactured VRLA batteries are UL-recognized components under UL924 and UL1989.

CSB is also certified by ISO 9001 and ISO 14001.

## ► Dimensions :

Unit: mm (inch)

Overall Height (H)	Container height (h)	Length (L)	Width (W)
98.3±1 (3.87±0.04)	94±1 (3.7±0.04)	151±2 (5.94±0.08)	51±1.2 (2.01±0.05)

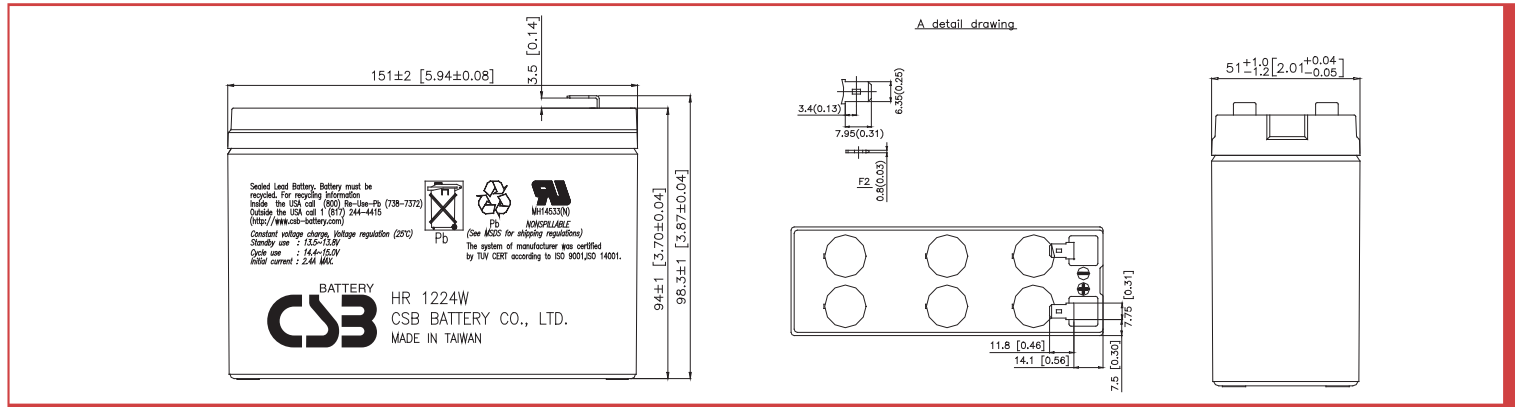

## Constant Current Discharge Characteristics Unit:A (25°C, 77°F)

F.V/Time	2MIN	4MIN	6MIN	8MIN	10MIN	15MIN	20MIN	30MIN	60MIN	90MIN
1.60V	47.5	33.0	26.1	22.0	18.9	14.0	11.0	7.95	4.29	3.43
1.67V	44.1	31.1	24.7	21.0	18.0	13.5	10.6	7.76	4.20	3.34
1.70V	42.7	30.3	24.0	20.5	17.6	13.2	10.5	7.67	4.15	3.30
1.75V	40.5	28.8	23.0	19.8	17.0	12.8	10.2	7.56	4.10	3.26
1.80V	38.4	27.4	22.2	19.1	16.4	12.5	10.0	7.49	4.06	3.22
1.85V	36.4	26.0	21.3	18.5	16.0	12.1	9.84	7.44	4.04	3.19

## Constant Power Discharge Characteristics Unit:W (25°C, 77°F)

F.V/Time	2MIN	4MIN	6MIN	8MIN	10MIN	15MIN	20MIN	30MIN	60MIN	90MIN
1.60V	570	396	313	264	228	168	132	95.4	51.5	41.2
1.67V	529	373	297	251	217	162	128	92.9	50.3	40.2
1.70V	512	363	289	246	212	159	126	92.1	49.9	39.7
1.75V	486	346	277	238	204	154	123	90.8	49.3	39.2
1.80V	461	329	266	229	197	149	121	89.9	48.8	38.8
1.85V	437	314	256	219	187	144	119	89.2	48.5	38.6

## Trickle (or Float) Service Life

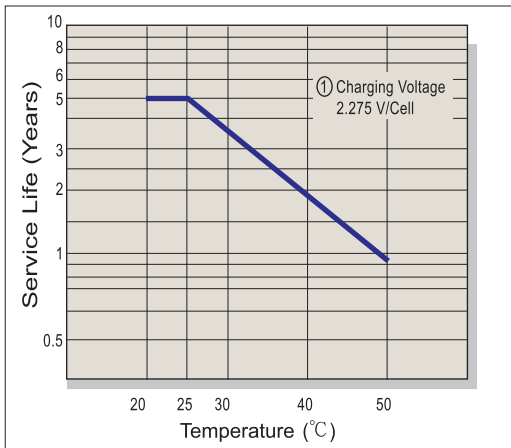

## Capacity Retention Characteristic

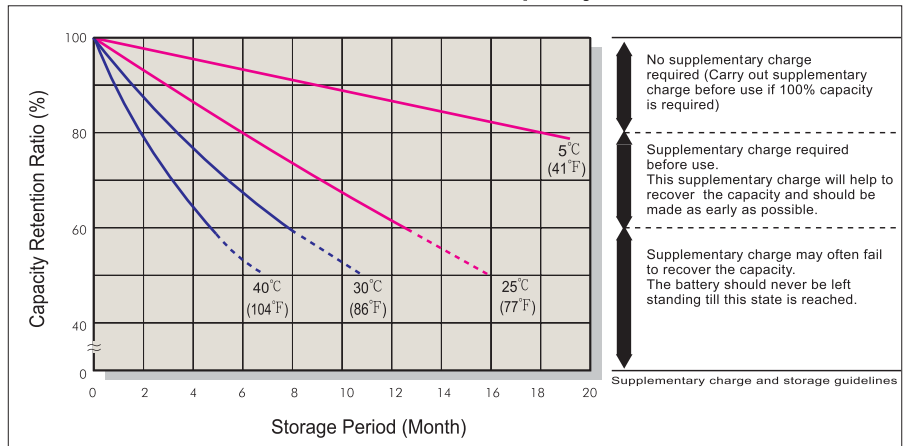

## Battery Voltage and Charge Time for Standby Use

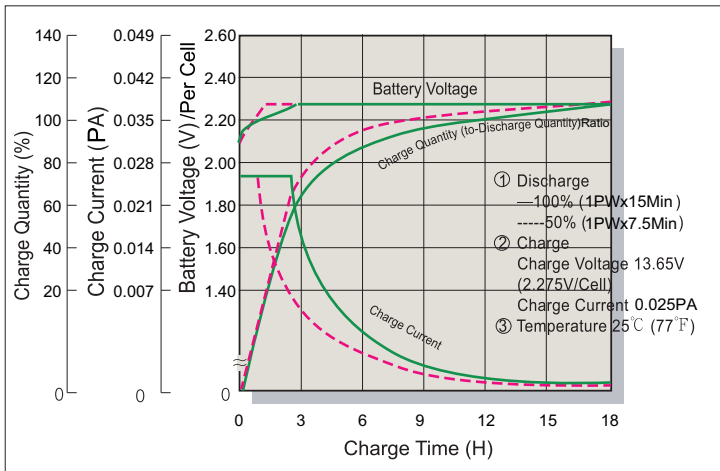

## Cycle Service Life

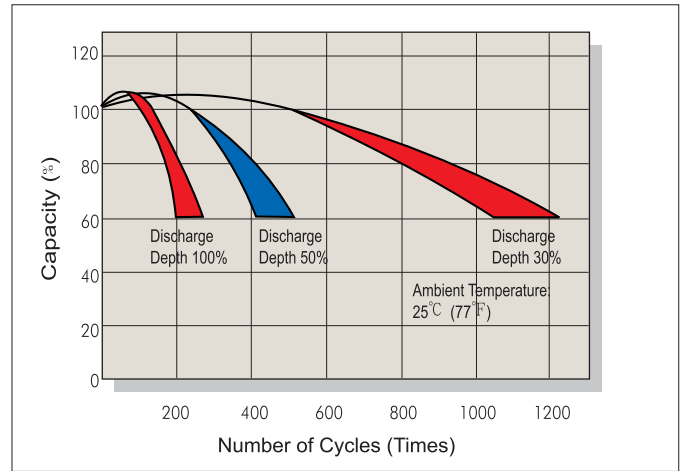

## Battery Voltage and Charge Time for Cycle Use

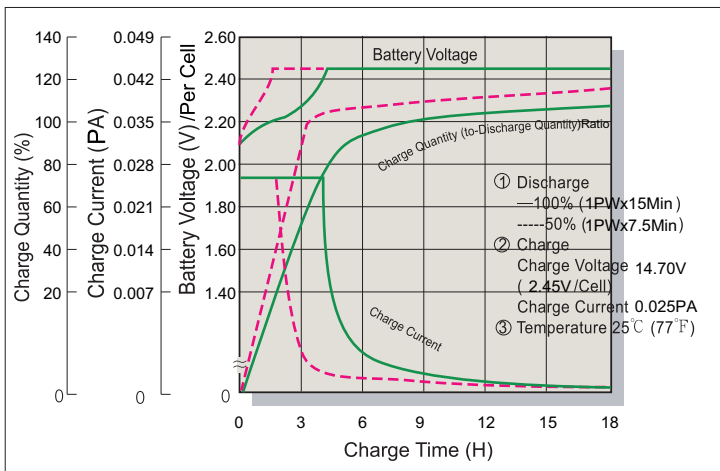

## Terminal Voltage (V) and Discharge Time

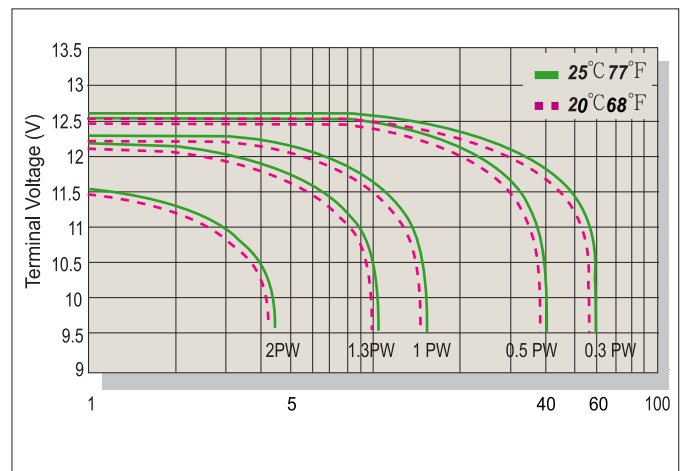

## Charging Procedures

Application	Charge Voltage(V/Cell)			Max.Charge Current
	Temperature	Set Point	Allowable Range	
Cycle Use	25°C (77°F)	2.45	2.40~2.50	0.1PA
Standby	25°C (77°F)	2.275	2.25~2.30	

## Discharge Current VS. Discharge Voltage

Final Discharge Voltage V/Cell	1.75	1.70	1.60	1.30
Discharge Power(W)	0.1P>(W)	0.1P≤(W)<0.25P	0.25P≤(W)<1.0P	(W)≥1.0P

Sales Office URL: [WWW.CSB-BATTERY.COM](http://WWW.CSB-BATTERY.COM)

**GLOBAL HQ**  
**CSB BATTERY CO., LTD. (TAIWAN)**  
 Tel : +886-2-2555-5600  
 Fax : +886-2-2555-3300  
 mail : service@csb-battery.com.tw

**BEIJING OFFICE. (CHINA)**  
**CSB BATTERY TECHNOLOGIES (BEIJING) CO., LTD.**  
 Tel : +86-10-59621300/1301/1302/1303  
 Fax : +86-10-59621304  
 mail : chinasl@csb-battery.com

**AMERICA HQ**  
**CSB BATTERY TECHNOLOGIES INC. (U.S.A)**  
 Tel : +1-817-244-7777/1-(800)3-CSB-USA(272872)  
 Fax : +1-817-244-4445  
 mail : csb@csb-battery.com

**SHANGHAI OFFICE. (CHINA)**  
**CSB BATTERY LOGISTIC (SHANGHAI) CO., LTD.**  
 Tel : +86-21-5046-1622/5046-0833  
 Fax : +86-21-5064-3314  
 mail : chinasl@csb-battery.com

**EUROPE HQ**  
**CSB Battery Europe BV.**  
 Tel : +31(0)-180-418-140  
 Fax : +886-2-2555-3300  
 mail : eurossales@csb-battery.eu

**SHENZHEN OFFICE. (CHINA)**  
**CSB BATTERY LOGISTIC (SHANGHAI) CO., LTD.**  
 Tel : +86-755-8831-6488/6396/6356  
 Fax : +86-755-8831-6548  
 mail : she@csb-battery.com.cn