

EVALUATION KIT  
AVAILABLE



# Low-Power, Single, 16-/12-Bit, Buffered Voltage-Output DACs

MAX5138/MAX5139

## General Description

The MAX5138/MAX5139 are a family of single-channel pin-compatible and software-compatible 16-bit and 12-bit DACs. The MAX5138/MAX5139 are low-power, 16-bit/12-bit, buffered voltage-output, high-linearity DACs. They use a precision internal reference or a precision external reference for rail-to-rail operation. The MAX5138/MAX5139 accept a wide +2.7V to +5.25V supply-voltage range to accommodate most low-power and low-voltage applications. These devices accept a 3-wire SPI™-/QSPI™-/MICROWIRE™-/DSP-compatible serial interface to save board space and reduce the complexity of optically isolated and transformer-isolated applications. The digital interface's double-buffered hardware and software LDAC provide simultaneous output update. The serial interface features a  $\overline{\text{READY}}$  output for easy daisy-chaining of several MAX5138/MAX5139 devices and/or other compatible devices. The MAX5138/MAX5139 include a hardware input to reset the DAC outputs to zero or midscale upon power-up or reset, providing additional safety for applications that drive valves or other transducers that need to be off during power-up. The high linearity of the DACs makes these devices ideal for precision control and instrumentation applications. The MAX5138/MAX5139 are available in an ultra-small (3mm x 3mm), 16-pin TQFN package and are specified over the -40°C to +105°C extended industrial temperature range.

## Applications

Automatic Test Equipment  
Automatic Tuning  
Communication Systems  
Data Acquisition  
Gain and Offset Adjustment  
Portable Instrumentation  
Power-Amplifier Control  
Process Control and Servo Loops  
Programmable Voltage and Current Sources

**Functional Diagram and Typical Operating Circuit appear at end of data sheet.**

SPI and QSPI are trademarks of Motorola Inc.

MICROWIRE is a trademark of National Semiconductor Corp.



## Features

- ◆ 16-/12-Bit Resolution in a 3mm x 3mm, 16-Pin TQFN Package
- ◆ Hardware-Selectable on Power-Up or Reset-to-Zero/Midscale DAC Output
- ◆ Double-Buffered Input Registers
- ◆ LDAC Asynchronously Updates DAC Output
- ◆  $\overline{\text{READY}}$  Facilitates Daisy Chaining
- ◆ High-Performance 10ppm/°C Internal Reference
- ◆ Guaranteed Monotonic Over All Operating Conditions
- ◆ Wide +2.7V to +5.25V Supply Range
- ◆ Rail-to-Rail Buffered Output Operation
- ◆ Low Gain Error (Less Than  $\pm 0.5\%$  FS) and Offset (Less Than  $\pm 10\text{mV}$ )
- ◆ 30MHz 3-Wire SPI-/QSPI-/MICROWIRE-/DSP-Compatible Serial Interface
- ◆ CMOS-Compatible Inputs with Hysteresis
- ◆ Low Power Consumption ( $\text{I}_{\text{SHDN}} = 2\mu\text{A max}$ )

## Ordering Information

PART	PIN-PACKAGE	RESOLUTION (BITS)
MAX5138BGTE+	16 TQFN-EP*	16
MAX5139GTE+	16 TQFN-EP*	12

+Denotes a lead(Pb)-free/RoHS-compliant package.

\*EP = Exposed pad.

**Note:** All devices are specified over the -40°C to +105°C operating temperature range.

## Pin Configuration

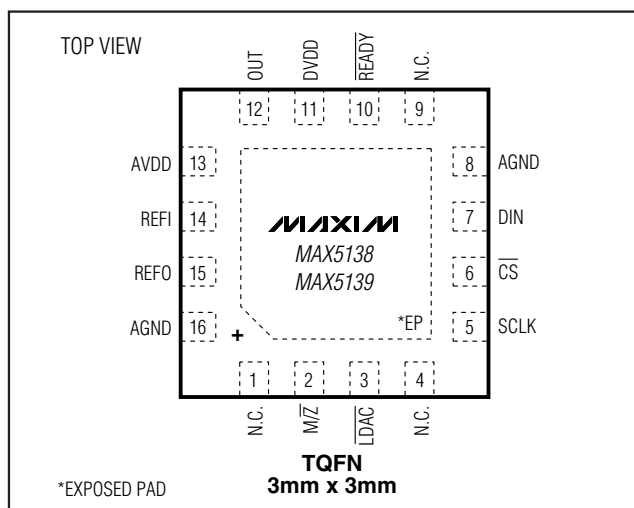

\*EXPOSED PAD

# Low-Power, Single, 16-/12-Bit, Buffered Voltage-Output DACs

## ABSOLUTE MAXIMUM RATINGS

AVDD to AGND .....	-0.3V to +6V
DVDD to AGND .....	-0.3V to +6V
OUT to AGND .....	-0.3V to the lower of (AVDD + 0.3V) and +6V
REFI, REFO, M/Z to AGND .....	-0.3V to the lower of (AVDD + 0.3V) and +6V
SCLK, DIN, CS to AGND .....	-0.3V to the lower of (DVDD + 0.3V) and +6V
LDAC, READY to AGND .....	-0.3V to the lower of (DVDD + 0.3V) and +6V

Continuous Power Dissipation (T <sub>A</sub> = +70°C) 16-Pin TQFN (derate at 14.7mW/°C above +70°C) ..	1176.5mW
Maximum Current into Any Input or Output with the Exception of M/Z Pin .....	±50mA
Maximum Current into M/Z Pin .....	±5mA
Operating Temperature Range .....	-40°C to +105°C
Storage Temperature Range .....	-65°C to +150°C
Lead Temperature (soldering, 10s) .....	+300°C

Stresses beyond those listed under "Absolute Maximum Ratings" may cause permanent damage to the device. These are stress ratings only, and functional operation of the device at these or any other conditions beyond those indicated in the operational sections of the specifications is not implied. Exposure to absolute maximum rating conditions for extended periods may affect device reliability.

## ELECTRICAL CHARACTERISTICS

(V<sub>AVDD</sub> = 2.7V to 5.25V, V<sub>DVDD</sub> = 2.7V to 5.25V, V<sub>AVDD</sub> ≥ V<sub>DVDD</sub>, V<sub>AGND</sub> = 0, V<sub>REFI</sub> = V<sub>AVDD</sub> - 0.25V, C<sub>OUT</sub> = 200pF, R<sub>OUT</sub> = 10kΩ, T<sub>A</sub> = T<sub>MIN</sub> to T<sub>MAX</sub>, unless otherwise noted. Typical values are at T<sub>A</sub> = +25°C.)

PARAMETER	SYMBOL	CONDITIONS	MIN	TYP	MAX	UNITS
<b>STATIC ACCURACY (Notes 1, 2)</b>						
Resolution	N	MAX5138	16			Bits
		MAX5139	12			
MAX5138 Integral Nonlinearity	INL	V <sub>REFI</sub> = 5V, AVDD = 5.25V	(Note 3) -9	±2	+11	LSB
					±6	
MAX5139 Integral Nonlinearity	INL	V <sub>REFI</sub> = 5V, AVDD = 5.25V	-1	±0.25	+1	LSB
Differential Nonlinearity	DNL	Guaranteed monotonic	-1.0		+1.0	LSB
Offset Error	OE	(Note 4)	-10	±1	+10	mV
Offset-Error Drift				±4		μV/°C
Gain Error	GE	(Note 4)	-0.5	±0.2	+0.5	% of FS
Gain Temperature Coefficient				±2		ppm FS/°C
<b>REFERENCE INPUT</b>						
Reference-Input Voltage Range	V <sub>REFI</sub>	AVDD = 3V to 5.25V	2		AVDD	V
		AVDD = 2.7V to 3V	2		AVDD - 0.2	
Reference Input Impedance			113			kΩ
<b>INTERNAL REFERENCE</b>						
Reference Voltage	V <sub>REFO</sub>	T <sub>A</sub> = +25°C	2.437	2.440	2.443	V
Reference Temperature Coefficient		(Note 5)		10	25	ppm/°C
Reference Output Impedance				1		Ω
Line Regulation				100		ppm/V
Maximum Capacitive Load	C <sub>R</sub>			0.1		nF

# Low-Power, Single, 16-/12-Bit, Buffered Voltage-Output DACs

MAX5138/MAX5139

## ELECTRICAL CHARACTERISTICS (continued)

( $V_{AVDD} = 2.7V$  to  $5.25V$ ,  $V_{DVDD} = 2.7V$  to  $5.25V$ ,  $V_{AVDD} \geq V_{DVDD}$ ,  $V_{AGND} = 0$ ,  $V_{REF1} = V_{AVDD} - 0.25V$ ,  $C_{OUT} = 200pF$ ,  $R_{OUT} = 10k\Omega$ ,  $T_A = T_{MIN}$  to  $T_{MAX}$ , unless otherwise noted. Typical values are at  $T_A = +25^\circ C$ .)

PARAMETER	SYMBOL	CONDITIONS	MIN	TYP	MAX	UNITS
<b>DAC OUTPUT VOLTAGE (Note 2)</b>						
Output Voltage Range		No load	0.02		$V_{AVDD} - 0.02$	V
DC Output Impedance				0.1		$\Omega$
Maximum Capacitive Load (Note 5)	$C_L$	Series resistance = $0\Omega$		0.2		nF
		Series resistance = $500\Omega$		15		$\mu F$
Resistive Load	$R_L$		2			$k\Omega$
Short-Circuit Current	$I_{SC}$	$V_{AVDD} = 5.25V$		$\pm 35$		mA
		$V_{AVDD} = 2.7V$	-40	$\pm 20$	+40	
Power-Up Time		From power-down mode		25		$\mu s$
<b>DIGITAL INPUTS (SCLK, DIN, CS, LDAC) (Note 6)</b>						
Input High Voltage	$V_{IH}$		$0.7 \times DVDD$			V
Input Low Voltage	$V_{IL}$				$0.3 \times DVDD$	V
Input Leakage Current	$I_{IN}$	$V_{IN} = 0$ or $DVDD$	-1	$\pm 0.1$	+1	$\mu A$
Input Capacitance	$C_{IN}$				10	pF
<b>DIGITAL OUTPUTS (READY)</b>						
Output High Voltage	$V_{OH}$	$I_{SOURCE} = 3mA$	$DVDD - 0.5$			V
Output Low Voltage	$V_{OL}$	$I_{SINK} = 2mA$			0.4	V
<b>DYNAMIC PERFORMANCE</b>						
Voltage-Output Slew Rate	SR	Positive and negative		1.25		V/ $\mu s$
Voltage-Output Settling Time	$t_S$	1/4 scale to 3/4 scale $V_{REF1} = V_{AVDD} = 5V$ settle to $\pm 2$ LSB (Note 5)		5		$\mu s$
Digital Feedthrough		Code 0, all digital inputs from 0 to $DVDD$		0.5		nV•s
Major Code Transition Analog Glitch Impulse				25		nV•s
Output Noise		10kHz		120		nV/ $\sqrt{Hz}$
Integrated Output Noise		1Hz to 10kHz		18		$\mu V$

# Low-Power, Single, 16-/12-Bit, Buffered Voltage-Output DACs

## ELECTRICAL CHARACTERISTICS (continued)

( $V_{AVDD} = 2.7V$  to  $5.25V$ ,  $V_{DVDD} = 2.7V$  to  $5.25V$ ,  $V_{AVDD} \geq V_{DVDD}$ ,  $V_{AGND} = 0$ ,  $V_{REFI} = V_{AVDD} - 0.25V$ ,  $C_{OUT} = 200pF$ ,  $R_{OUT} = 10k\Omega$ ,  $T_A = T_{MIN}$  to  $T_{MAX}$ , unless otherwise noted. Typical values are at  $T_A = +25^\circ C$ .)

PARAMETER	SYMBOL	CONDITIONS	MIN	TYP	MAX	UNITS
<b>POWER REQUIREMENTS (Note 7)</b>						
Analog Supply Voltage Range	AVDD		2.7		5.25	V
Digital Supply Voltage Range	DVDD		2.7		AVDD	V
Supply Current	$I_{AVDD}$	No load, all digital inputs at 0 or DVDD		1	1.6	mA
	$I_{DVDD}$			1	10	$\mu A$
Power-Down Supply Current	$I_{AVPD}$	No load, all digital inputs at 0 or DVDD		0.2	2	$\mu A$
	$I_{DVPD}$			0.1	2	$\mu A$
<b>TIMING CHARACTERISTICS (Note 8) (Figure 1)</b>						
Serial-Clock Frequency	$f_{SCLK}$		0		30	MHz
SCLK Pulse-Width High	$t_{CH}$		13			ns
SCLK Pulse-Width Low	$t_{CL}$		13			ns
$\overline{CS}$ Fall-to-SCLK Fall Setup Time	$t_{CSS}$		8			ns
SCLK Fall-to $\overline{CS}$ -Rise Hold Time	$t_{CSH}$		5			ns
DIN-to-SCLK Fall Setup Time	$t_{DS}$		10			ns
DIN-to-SCLK Fall Hold Time	$t_{DH}$		2			ns
SCLK Fall to $\overline{READY}$ Transition	$t_{SRL}$	(Note 9)			30	ns
$\overline{CS}$ Pulse-Width High	$t_{CSW}$		33			ns
LDAC Pulse Width	$t_{LDACPWL}$		33			ns

**Note 1:** Static accuracy tested without load.

**Note 2:** Linearity is tested within 20mV of AGND and AVDD, allowing for gain and offset error.

**Note 3:** Codes above 2047 are guaranteed to be within  $\pm 9$  LSB.

**Note 4:** Gain and offset tested within 100mV of AGND and AVDD.

**Note 5:** Guaranteed by design.

**Note 6:** Device draws current in excess of the specified supply current when a digital input is driven with a voltage of  $V_I < DVDD - 0.6V$  or  $V_I > 0.5V$ . At  $V_I = 2.2V$  with  $DVDD = 5.25V$ , this current can be as high as 2mA. The SPI inputs are CMOS-input-level compatible. The 30MHz clock frequency cannot be guaranteed for a minimum signal swing.

**Note 7:** Excess current from AVDD is 10mA when powered without DVDD. Excess current from DVDD is 1mA when powered without AVDD.

**Note 8:** All timing specifications are with respect to the digital input and output thresholds.

**Note 9:** Maximum daisy-chain clock frequency is limited to 25MHz.

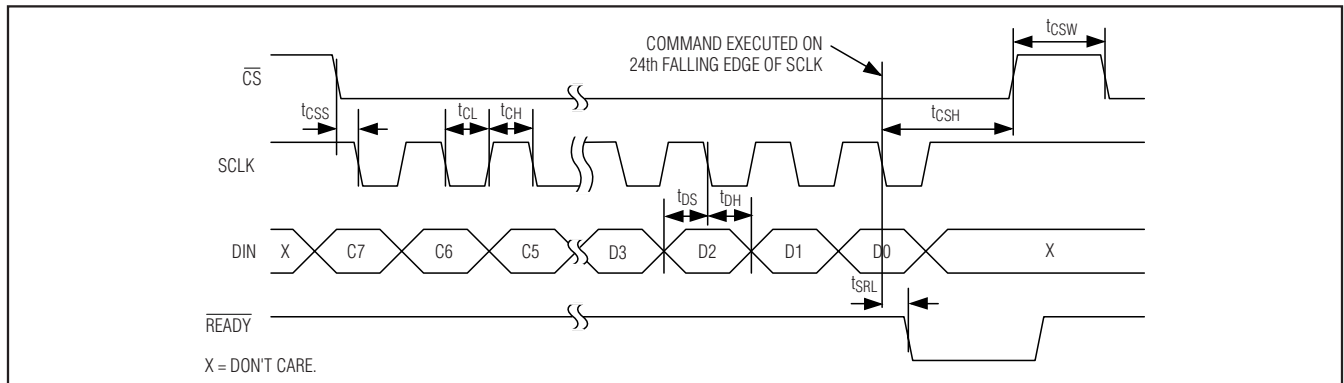

Figure 1. Serial-Interface Timing Diagram

# Low-Power, Single, 16-/12-Bit, Buffered Voltage-Output DACs

## Typical Operating Characteristics

( $T_A = +25^\circ\text{C}$ , unless otherwise noted.)

MAX5138/MAX5139

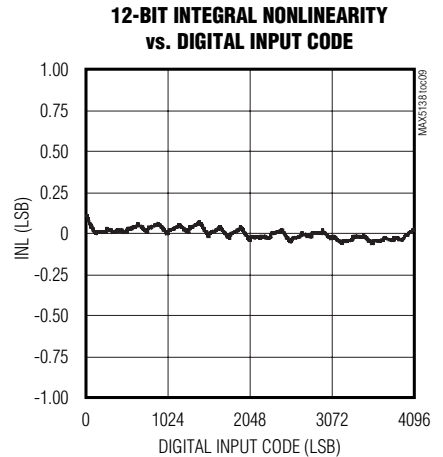
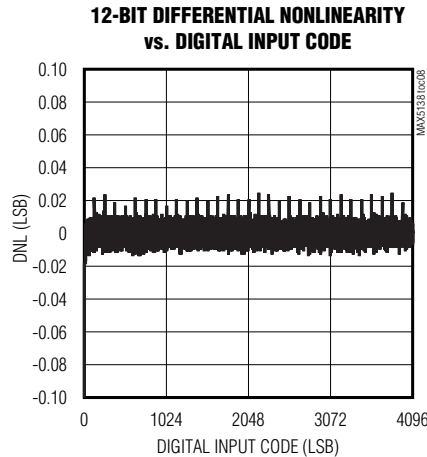
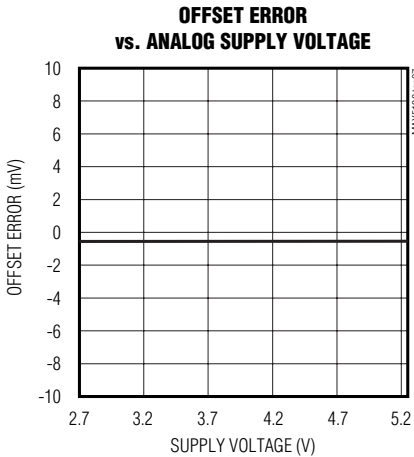
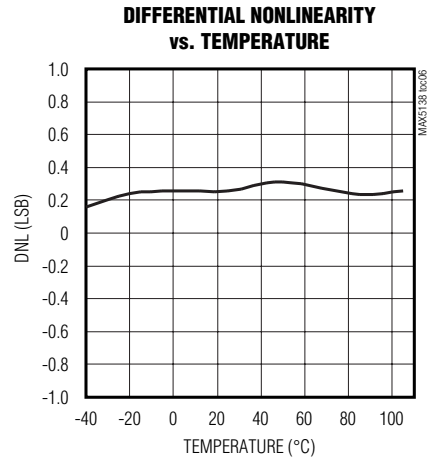
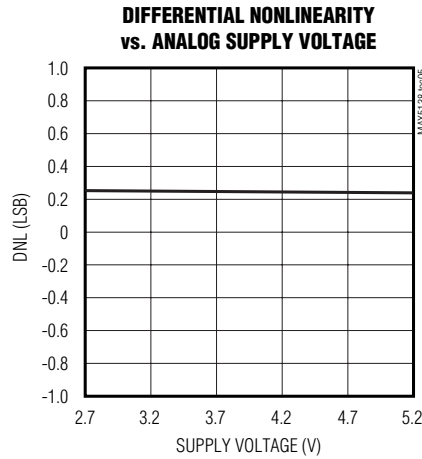
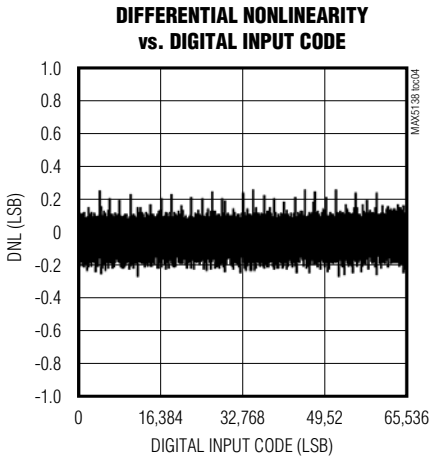
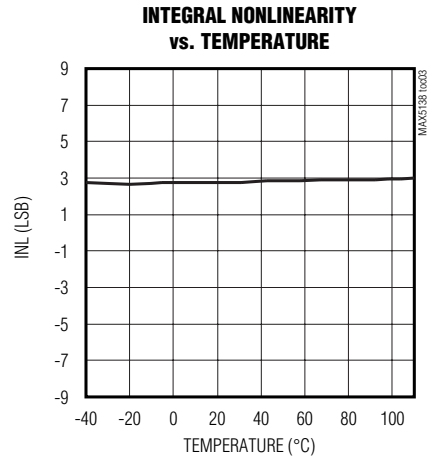
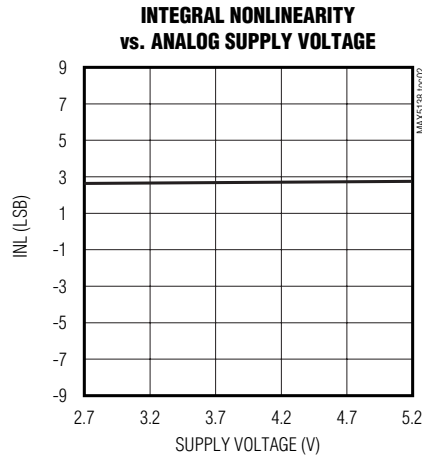
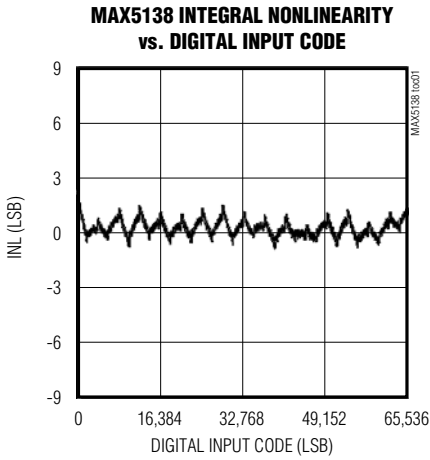

# Low-Power, Single, 16-/12-Bit, Buffered Voltage-Output DACs

## Typical Operating Characteristics (continued)

( $T_A = +25^\circ\text{C}$ , unless otherwise noted.)

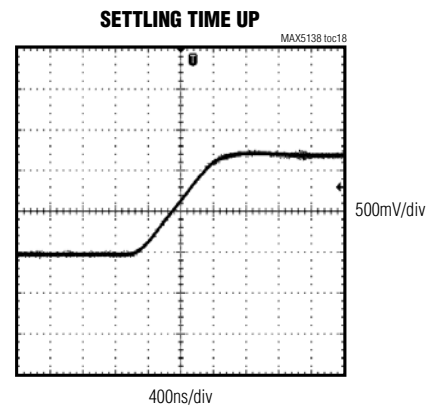
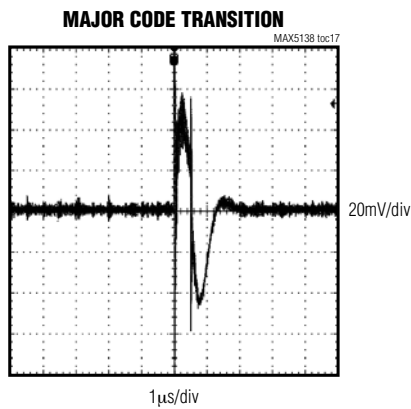
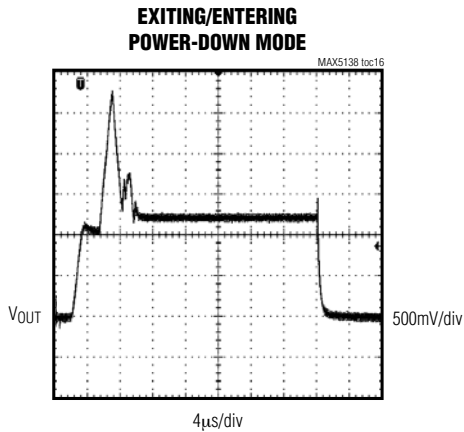
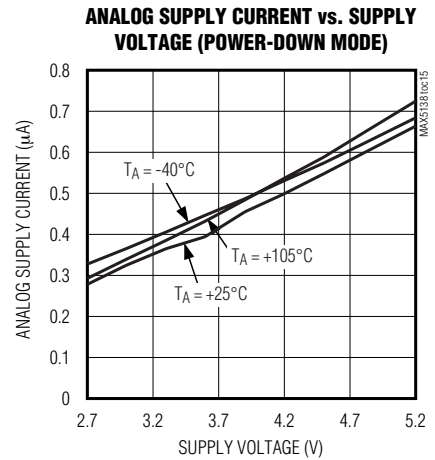
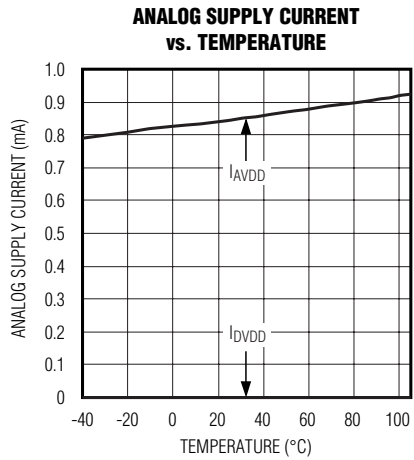
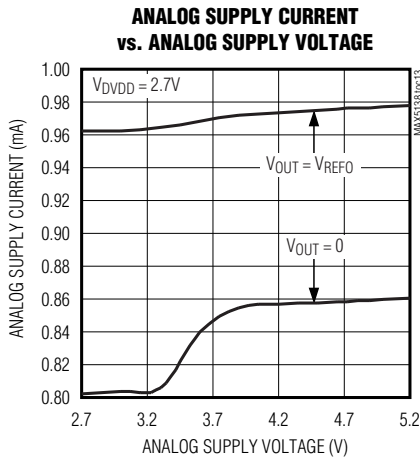
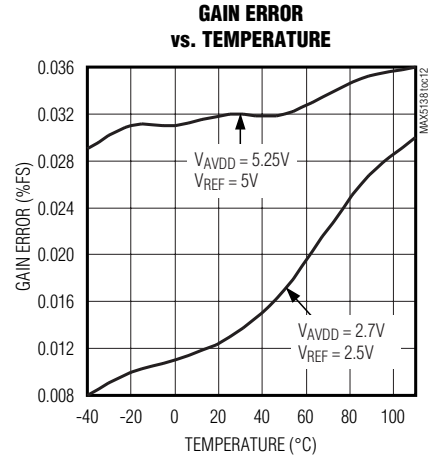
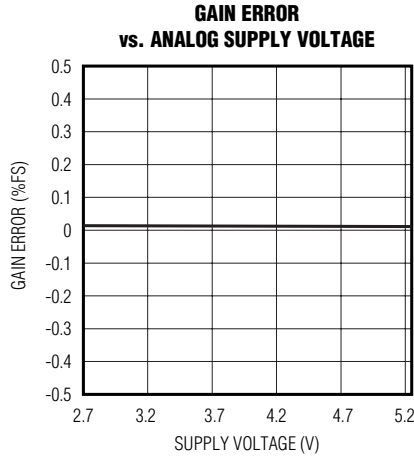
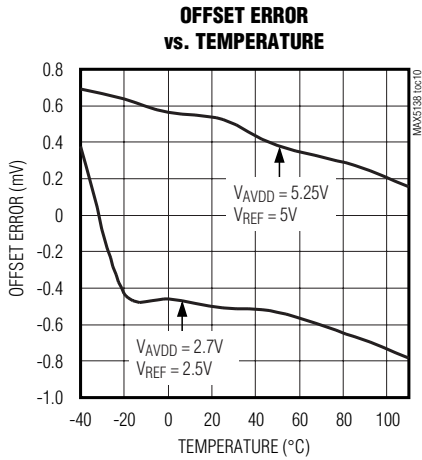

# Low-Power, Single, 16-/12-Bit, Buffered Voltage-Output DACs

## Typical Operating Characteristics (continued)

( $T_A = +25^\circ\text{C}$ , unless otherwise noted.)

MAX5138/MAX5139

**SETTLING TIME DOWN**

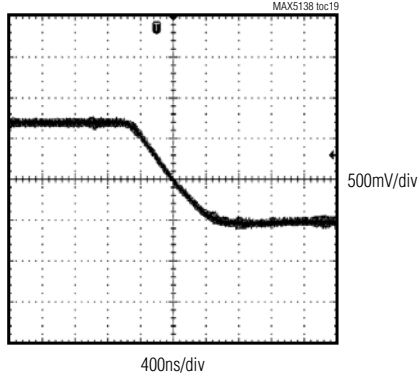

**DIGITAL FEEDTHROUGH**

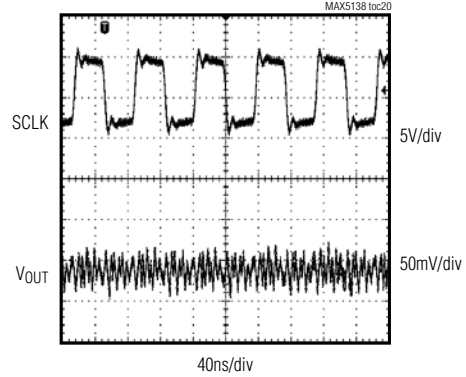

**DIGITAL SUPPLY CURRENT vs. DIGITAL SUPPLY VOLTAGE**

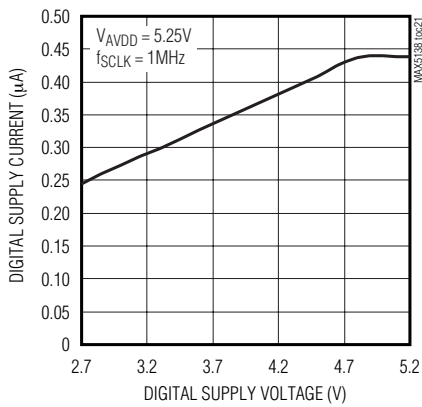

**REFERENCE VOLTAGE vs. SUPPLY VOLTAGE**

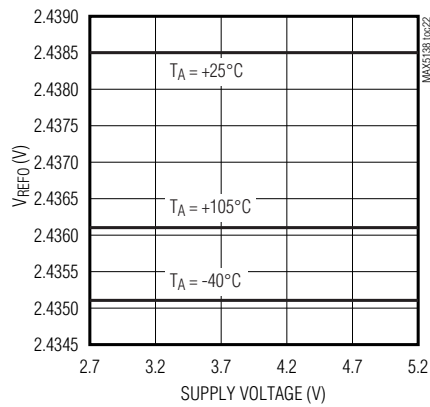

**REFERENCE VOLTAGE vs. TEMPERATURE**

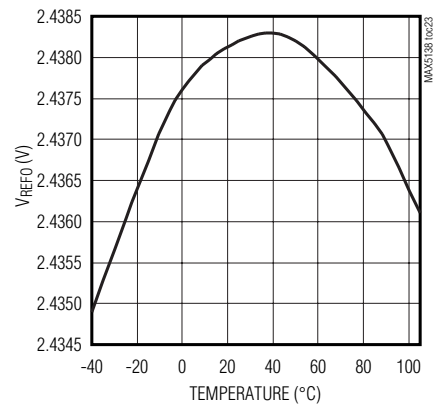

**DIGITAL SUPPLY CURRENT vs. DIGITAL INPUT VOLTAGE**

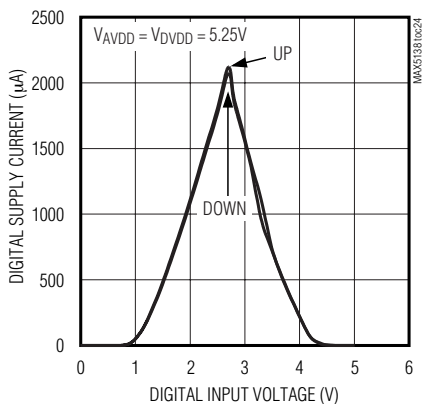

**FULL-SCALE OUTPUT vs. TEMPERATURE**

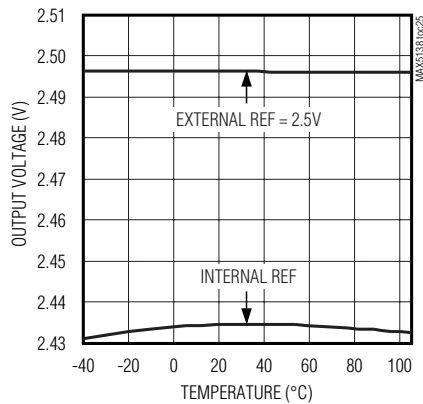

**OUTPUT VOLTAGE vs. SUPPLY CURRENT**

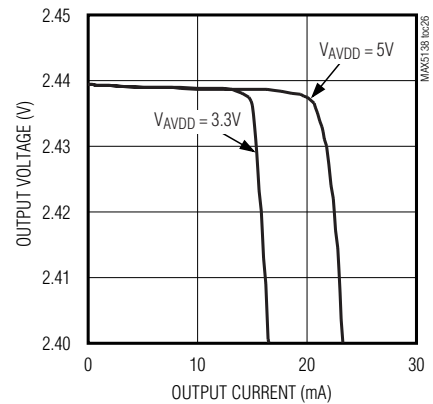

# Low-Power, Single, 16-/12-Bit, Buffered Voltage-Output DACs

## Typical Operating Characteristics (continued)

( $T_A = +25^\circ\text{C}$ , unless otherwise noted.)

**FULL-SCALE REFERENCE FEEDTHROUGH**

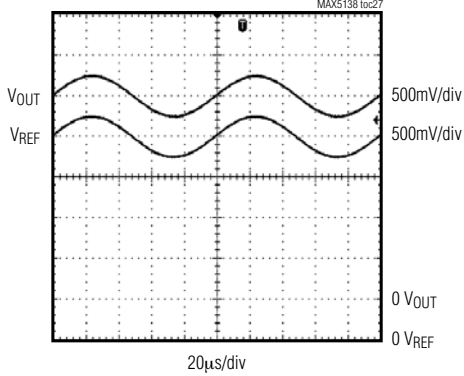

**ZERO-SCALE REFERENCE FEEDTHROUGH**

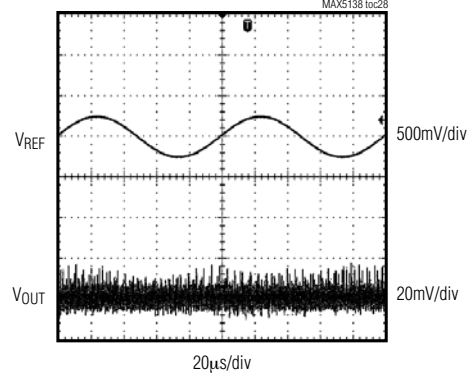

**REFERENCE INPUT RESPONSE vs. FREQUENCY**

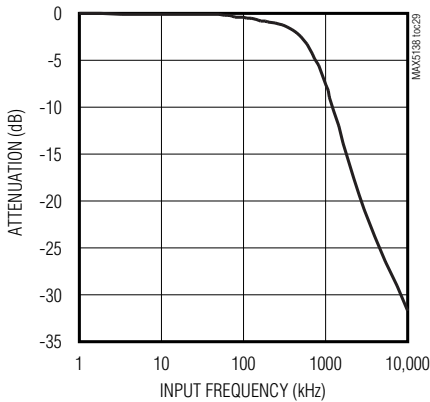

**POWER-UP GLITCH, ZERO-SCALE, EXTERNAL REFERENCE**

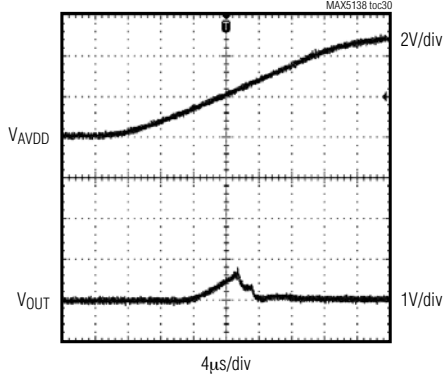

**POWER-UP GLITCH, ZERO-SCALE, INTERNAL REFERENCE**

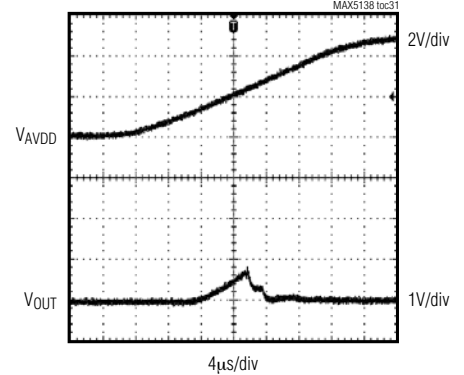

**POWER-UP GLITCH, MIDSCALE, EXTERNAL REFERENCE**

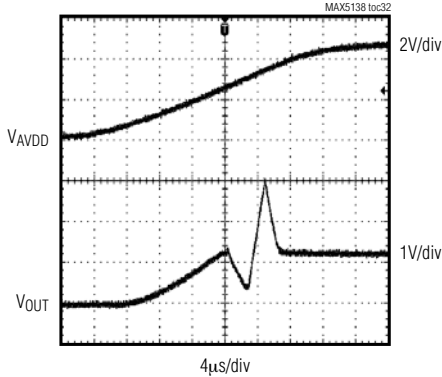

**POWER-UP GLITCH, MIDSCALE, INTERNAL REFERENCE**

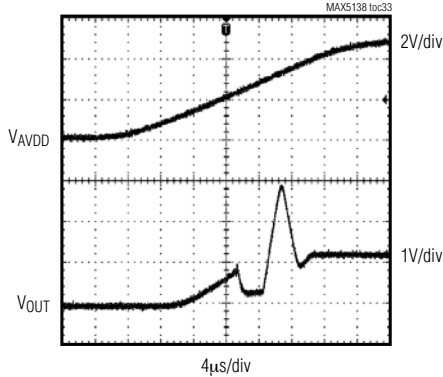

**DC NOISE SPECTRUM, FFT PLOT BUFFERED OUTPUT**

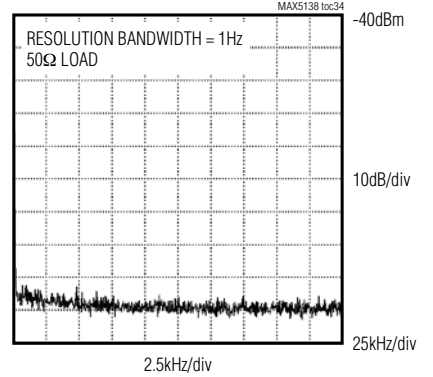



# Low-Power, Single, 16-/12-Bit, Buffered Voltage-Output DACs

MAX5138/MAX5139

## Pin Description

PIN	NAME	FUNCTION
1, 4, 9	N.C.	No Connection. Not internally connected.
2	$M/\bar{Z}$	Power-Up Reset Select. Connect $M/\bar{Z}$ low to AGND to power up the DAC output. Connect $M/\bar{Z}$ high to power up the DAC output to midscale.
3	$\bar{L}DAC$	Load DAC. Active-low hardware load DAC input.
5	SCLK	Serial-Clock Input
6	$\bar{CS}$	Active-Low Chip-Select Input
7	DIN	Data In
8	AGND	Analog Ground. Internally connected to AGND. Connect AGND to AGND externally.
10	$\bar{READY}$	Data Output
11	DVDD	Digital Power Supply. Bypass DVDD with a 0.1 $\mu$ F capacitor to AGND.
12	OUT	Buffered DAC Output
13	AVDD	Analog Power Supply. Bypass AVDD with a 0.1 $\mu$ F capacitor to AGND.
14	REFI	Reference Voltage Input. Bypass REFI with a 0.1 $\mu$ F capacitor to AGND.
15	REFO	Reference Voltage Output
16	AGND	DAC Ground. Internally connected to AGND. Connect AGND to AGND externally.
—	EP	Exposed Pad. Not internally connected. Connect to a ground or leave unconnected. Not intended as an electrical connection point.

## Detailed Description

The MAX5138/MAX5139 are a family of single-channel, pin-compatible and software-compatible, 16-bit and 12-bit DACs. The parts are low-power, buffered voltage-output, high-linearity DACs. The MAX5138/MAX5139 minimize the digital noise feedthrough from input to output by powering down the SCLK and DIN input buffers after completion of each 24-bit serial input. On power-up, the MAX5138/MAX5139 reset the DAC output to zero or midscale, depending on the state of the  $M/\bar{Z}$  input, providing additional safety for applications that drive valves or other transducers that need to be off on power-up. The MAX5138/MAX5139 contain a segmented resistor string-type DAC, a serial-in parallel-out shift register, a DAC register, power-on reset (POR) circuit, and control logic. On the falling edge of the clock (SCLK) pulse, the serial input (DIN) data is shifted into the device, MSB first. During power-down, an internal 80k $\Omega$  resistor pulls DAC outputs to AGND.

## Output Amplifier (OUT)

The MAX5138/MAX5139 include an internal buffer for the DAC output. The internal buffer provides improved load regulation and transition glitch suppression for the DAC output. The output buffer slews at 1.25V/ $\mu$ s and drives up to 2k $\Omega$  in parallel with 200pF. The analog supply voltage (AVDD) determines the maximum output voltage range of the device as AVDD powers the output buffer.

## DAC Reference

### Internal Reference

The MAX5138/MAX5139 feature an internal reference with a nominal +2.44V output. Connect REFO to REFI when using the internal reference. Bypass REFO to AGND with a 47pF (maximum 100pF) capacitor. Alternatively, if heavier decoupling is required, add a 1k $\Omega$  resistor in series with a 1 $\mu$ F capacitor in parallel with the existing 100pF capacitor. REFO can deliver up to 100 $\mu$ A of current with no degradation in performance. Configure other reference voltages by applying a resistive potential divider with a total resistance greater than 33k $\Omega$  from REFO to AGND.

# Low-Power, Single, 16-/12-Bit, Buffered Voltage-Output DACs

## External Reference

The external reference input features a typical input impedance of 113k $\Omega$  and accepts an input voltage from +2V to AVDD. Connect an external voltage supply between REFI and AGND to apply an external reference. Leave REFO unconnected. Visit [www.maxim-ic.com/products/references](http://www.maxim-ic.com/products/references) for a list of available external voltage-reference devices.

## AVDD as Reference

Connect AVDD to REFI to use AVDD as the reference voltage. Leave REFO unconnected.

## Serial Interface

The MAX5138/MAX5139 3-wire serial interface is compatible with MICROWIRE, SPI, QSPI, and DSPs (Figures 2, 3). The interface provides three inputs, SCLK,  $\overline{CS}$ , and DIN and one output, READY. Use READY to verify communication or to daisy-chain multiple devices (see the *READY* section). READY is capable of driving a 20pF load with a 30ns (max) delay from the falling edge of SCLK. The chip-select input ( $\overline{CS}$ ) frames the serial data loading at DIN. Following a chip-select input's

high-to-low transition, the data is shifted synchronously and latched into the input register on each falling edge of the serial-clock input (SCLK). Each serial word is 24 bits. The first 8 bits are the control word followed by 16 data bits (MSB first), as shown in Table 1. The serial input register transfers its contents to the input registers after loading 24 bits of data. To initiate a new data transfer, drive  $\overline{CS}$  high and keep  $\overline{CS}$  high for a minimum of 33ns before the next write sequence. The SCLK can be either high or low between  $\overline{CS}$  write pulses. Figure 1 shows the timing diagram for the complete 3-wire serial-interface transmission.

The MAX5138/MAX5139 digital input is double buffered. Depending on the command issued through the serial interface, the input register can be loaded without affecting the DAC register using the write command. To update the DAC register, either pulse the  $\overline{LDAC}$  input low, or use the software  $\overline{LDAC}$  command. Use the writethrough commands (see Table 1) to update the DAC output immediately after the data is received. Only use the writethrough command to update the DAC output immediately.

**Table 1. Operating Mode Truth Table**

24-BIT WORD																		DESC	FUNCTION
CONTROL BITS								DATA BITS											
MSB								LSB											
C7	C6	C5	C4	C3	C2	C1	C0	D15	D14	D13	D12	D11	D10	D9	D8	D7	D6–D0		
0	0	0	0	0	0	0	0	X	X	X	X	X	X	X	X	X	X	NOP	No operation.
0	0	0	0	0	0	0	1	X	X	X	X	X	X	X	DAC	X	X	LDAC	Set DAC = 1 to move contents of input to DAC register.
0	0	0	0	0	0	1	0	X	X	X	X	X	X	X	X	X	X	CLR	Software clear.
0	0	0	0	0	0	1	1	X	X	X	X	X	X	X	DAC	READY_EN	X	Power Control	Set DAC = 1 to power down DAC. Set READY_EN = 1 to enable READY.
0	0	0	0	0	1	0	1	0	0	0	0	0	0	LIN	0	0	0	Linearity	Optimize DAC linearity.
0	0	0	1	X	X	X	DAC	D15	D14	D13	D12	D11	D10	D9	D8	D7	D6	Write	Write to selected input registers (DAC output not affected).
0	0	1	1	X	X	X	DAC	D15	D14	D13	D12	D11	D10	D9	D8	D7	D6	Write-through	Write to selected input and DAC register, DAC output updated (writethrough).
0	0	1	0	0	0	0	0	X	X	X	X	X	X	X	X	X	X	NOP	No operation.

\*For the MAX5139, D3–D0 are X = don't-care bits.

# Low-Power, Single, 16-/12-Bit, Buffered Voltage-Output DACs

The MAX5138's DAC code is unipolar binary with  $V_{OUT} = (\text{code}/65536) \times V_{REF}$ . See Table 1 for the serial interface commands.

The MAX5139's DAC code is unipolar with  $V_{OUT} = (\text{code}/4096) \times V_{REF}$ . See Table 1 for the serial interface commands.

Connect the MAX5138/MAX5139 DVDD supply to the supply of the host DSP or microprocessor. The AVDD supply may be set to any voltage within the 2.7V to 5.25V operating range, but must be greater than or equal to the DVDD supply.

### Writing to the MAX5138/MAX5139

Write to the MAX5138/MAX5139 using the following sequence:

- 1) Drive  $\overline{CS}$  low, enabling the shift register.
- 2) Clock 24 bits of data into DIN (C7 first and D0 last), observing the specified setup and hold times. Bits

D15–D0 are the data bits that are written to the internal register.

- 3) After clocking in the last data bit, drive  $\overline{CS}$  high.  $\overline{CS}$  must remain high for 33ns before the next transmission is started.

Figure 1 shows a write operation for the transmission of 24 bits. If  $\overline{CS}$  is driven high at any point prior to receiving 24 bits, the transmission is discarded.

### READY

Connect  $\overline{READY}$  to a microcontroller ( $\mu\text{C}$ ) input to monitor the serial interface for valid communications. The  $\overline{READY}$  pulse appears 24 clock cycles after the negative edge of  $\overline{CS}$  (Figure 4). Since the MAX5138/MAX5139 look at the first 24 bits of the transmission following the falling edge of  $\overline{CS}$ , it is possible to daisy chain devices with different command word lengths.  $\overline{READY}$  goes high 16ns after  $\overline{CS}$  is driven high.

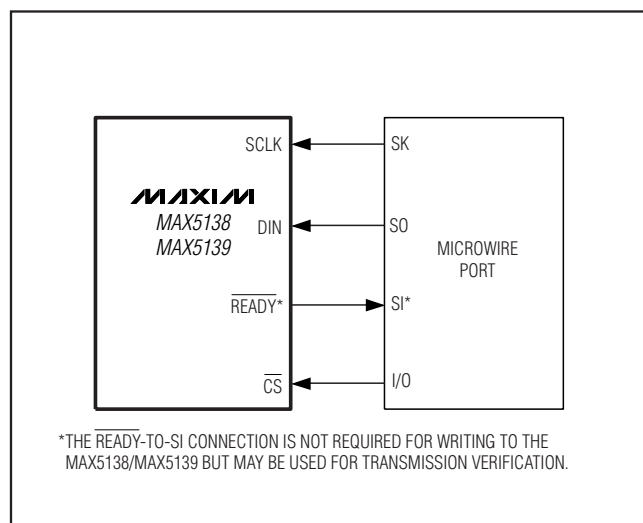

Figure 2. Connections for MICROWIRE

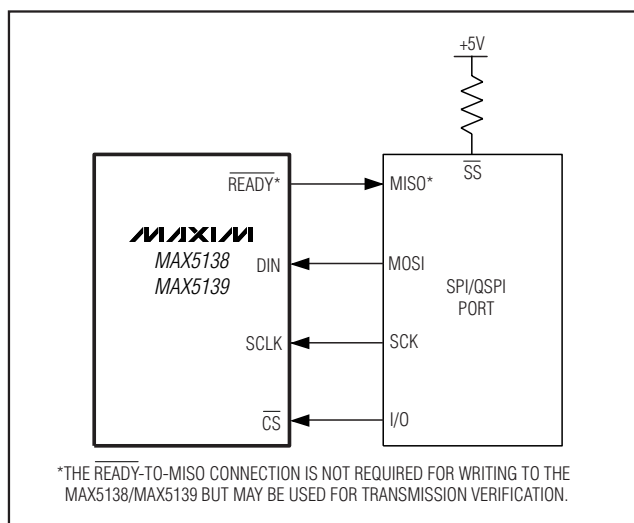

Figure 3. Connections for SPI/QSPI

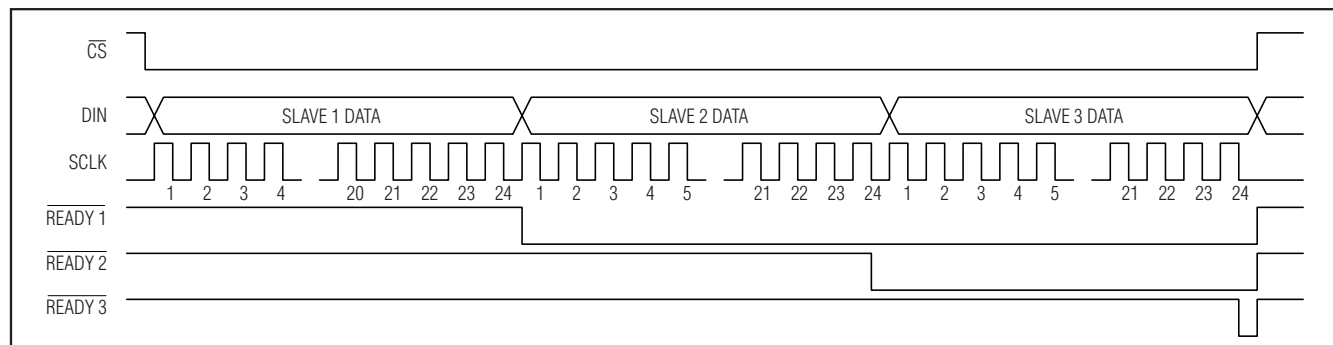

Figure 4.  $\overline{READY}$  Timing

## Low-Power, Single, 16-/12-Bit, Buffered Voltage-Output DACs

Daisy chain multiple MAX5138/MAX5139 devices by connecting the first device conventionally, then connect its  $\overline{\text{READY}}$  output to the  $\overline{\text{CS}}$  of the following device. Repeat for any other devices in the chain, and drive the SCLK and DIN lines in parallel (Figure 5). When sending commands to daisy-chained MAX5138/MAX5139s, the devices are accessed serially starting with the first device in the chain. The first 24 data bits are read by the first device, the second 24 data bits are read by the second device and so on (Figure 4). Figure 6 shows the configuration when  $\overline{\text{CS}}$  is not driven by the  $\mu\text{C}$ . These devices can be daisy chained with other compatible devices, such as the MAX5510 and the MAX5511.

To perform a daisy-chain write operation, drive  $\overline{\text{CS}}$  low and output the data serially to DIN. The propagation of the  $\overline{\text{READY}}$  signal then controls how the data is read by each device. As the data propagates through the daisy chain, each individual command in the chain is executed on the 24th falling clock edge following the falling edge of the respective  $\overline{\text{CS}}$  input. To update just one device in a daisy chain, send the no-op command to the other devices in the chain.

If  $\overline{\text{READY}}$  is not required, write command 0x03 (power control) and set  $\text{READY\_EN} = 0$  (see Table 1) to disable the  $\overline{\text{READY}}$  output.

### Clear Command

The MAX5138/MAX5139 feature a software clear command (0x02). The software clear command acts as a

software POR, erasing the contents of all registers. The output returns to the state determined by the  $\text{M}/\overline{\text{Z}}$  input.

### Power-Down Mode

The MAX5138/MAX5139 feature a software-controlled power-down mode. The internal reference and biasing circuits power down to conserve power when powered down. In power-down, the output disconnects from the buffer and is grounded with an internal  $80\text{k}\Omega$  resistor. The DAC register holds the retained code so that the output is restored when powered up. The serial interface remains active in power-down mode.

### Load DAC ( $\overline{\text{LDAC}}$ ) Input

The MAX5138/MAX5139 feature an active-low  $\overline{\text{LDAC}}$  logic input that updates the output. Keep  $\overline{\text{LDAC}}$  high during normal operation (when the device is controlled only through the serial interface). Drive  $\overline{\text{LDAC}}$  low to update the DAC output with data from the input register. Figure 7 shows the  $\overline{\text{LDAC}}$  timing with respect to OUT. Holding  $\overline{\text{LDAC}}$  low causes the input register to become transparent and data written to the DAC register to immediately update the DAC output. A software command can also activate the  $\overline{\text{LDAC}}$  operation. To activate  $\overline{\text{LDAC}}$  by software, set control word 0x01 to load the DAC, and all other data bits to don't care. See Table 1 for the data format. This operation updates the DAC output if it is flagged with a 1. If the DAC output is flagged with a 0 it remains unchanged.

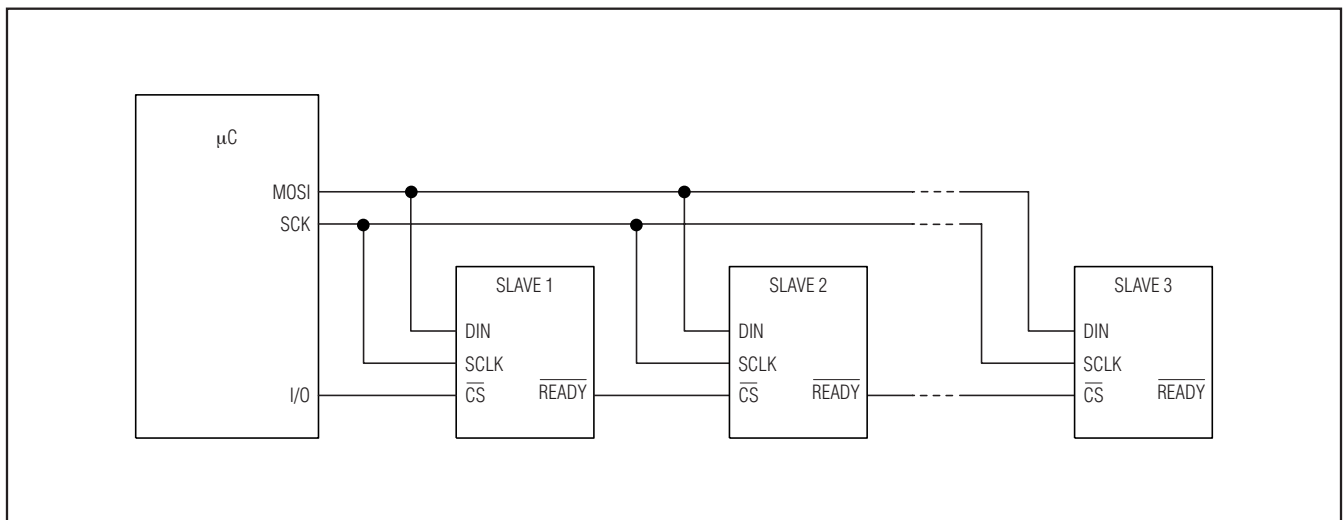

Figure 5. Daisy-Chain Configuration



# Low-Power, Single, 16-/12-Bit, Buffered Voltage-Output DACs

## Applications Information

### Power-On Reset (POR)

On power-up, the input register is set to zero, and the DAC output powers up to zero or midscale, depending on the configuration of  $M/\bar{Z}$ . Connect  $M/\bar{Z}$  to AGND to power the output to AGND. Connect  $M/\bar{Z}$  to AVDD to power the output to midscale.

To guarantee DAC linearity, wait until the supplies have settled. Set the LIN bit in the DAC linearity register; wait 10ms, and clear the LIN bit.

### Unipolar Output

The MAX5138/MAX5139 unipolar output voltage range is 0 to  $V_{REF}$ . The output buffer drives a  $2k\Omega$  load in parallel with 200pF.

### Bipolar Output

Use the MAX5138/MAX5139 in bipolar applications with additional external components (see the *Typical Operating Circuit*).

### Power Supplies and Bypassing Considerations

For best performance, use a separate supply for the MAX5138/MAX5139. Bypass both DVDD and AVDD with high-quality ceramic capacitors to a low-impedance ground as close as possible to the device. Minimize lead lengths to reduce lead inductance. Connect both MAX5138/MAX5139 AGND inputs to the analog ground plane.

**Table 2. MAX5138 Input Code vs. Output Voltage**

DAC LATCH CONTENTS		ANALOG OUTPUT, $V_{OUT}$
MSB	LSB	
1111 1111 1111 1111		$V_{REF} \times (65,535/65,536)$
1000 0000 0000 0000		$V_{REF} \times (32,768/65,536) = 1/2 V_{REF}$
0000 0000 0000 0001		$V_{REF} \times (1/65,536)$
0000 0000 0000 0000		0

## Layout Considerations

Digital and AC transient signals on AGND inputs can create noise at the outputs. Connect both AGND inputs to form the star ground for the DAC system. Refer remote DAC loads to this system ground for the best possible performance. Use proper grounding techniques, such as a multilayer board with a low-inductance ground plane, or star connect all ground return paths back to the MAX5138/MAX5139 AGND. Do not use wire-wrapped boards and sockets. Use shielding to improve noise immunity. Do not run analog and digital signals parallel to one another (especially clock signals) and avoid routing digital lines underneath the MAX5138/MAX5139 package.

## Definitions

### Integral Nonlinearity (INL)

INL is the deviation of the measured transfer function from a best fit straight line drawn between two codes. This best fit line for the MAX5138 is a line drawn between codes 3072 and 64,512 of the transfer function and the best fit line for the MAX5139 is a line drawn between codes 192 and 4032 of the transfer function, once offset and gain errors have been nullified.

### Differential Nonlinearity (DNL)

DNL is the difference between an actual step height and the ideal value of 1 LSB. If the magnitude of the DNL is greater than -1 LSB, the DAC guarantees no missing codes and is monotonic.

**Table 3. MAX5139 Input Code vs. Output Voltage**

DAC LATCH CONTENTS				ANALOG OUTPUT, $V_{OUT}$
MSB	LSB		LSB	
1111	1111	1111	XXX	$V_{REF} \times (4095/4096)$
1000	0000	0000	XXX	$V_{REF} \times (2048/4096)$
0000	0000	0001	XXX	$V_{REF} \times (1/4096)$
0000	0000	0000	XXX	0

# Low-Power, Single, 16-/12-Bit, Buffered Voltage-Output DACs

### Offset Error

Offset error indicates how well the actual transfer function matches the ideal transfer function at a single point. Typically, the point at which the offset error is specified is at or near the zero-scale point of the transfer function.

### Gain Error

Gain error is the difference between the ideal and the actual full-scale output voltage on the transfer curve, after nullifying the offset error. This error alters the slope of the transfer function and corresponds to the same percentage error in each step.

### Settling Time

The settling time is the amount of time required from the start of a transition, until the DAC output settles to the new output value within the converter's specified accuracy.

### Digital Feedthrough

Digital feedthrough is the amount of noise that appears on the DAC output when the DAC digital control lines are toggled.

### Digital-to-Analog Glitch Impulse

A major carry transition occurs at the midscale point where the MSB changes from low to high and all other bits change from high to low, or where the MSB changes from high to low and all other bits change from low to high. The duration of the magnitude of the switching glitch during a major carry transition is referred to as the digital-to-analog glitch impulse.

### Digital-to-Analog Power-Up Glitch Impulse

The digital-to-analog power-up glitch is the duration of the magnitude of the switching glitch that occurs as the device exits power-down mode.

### Chip Information

PROCESS: BiCMOS

### Functional Diagram

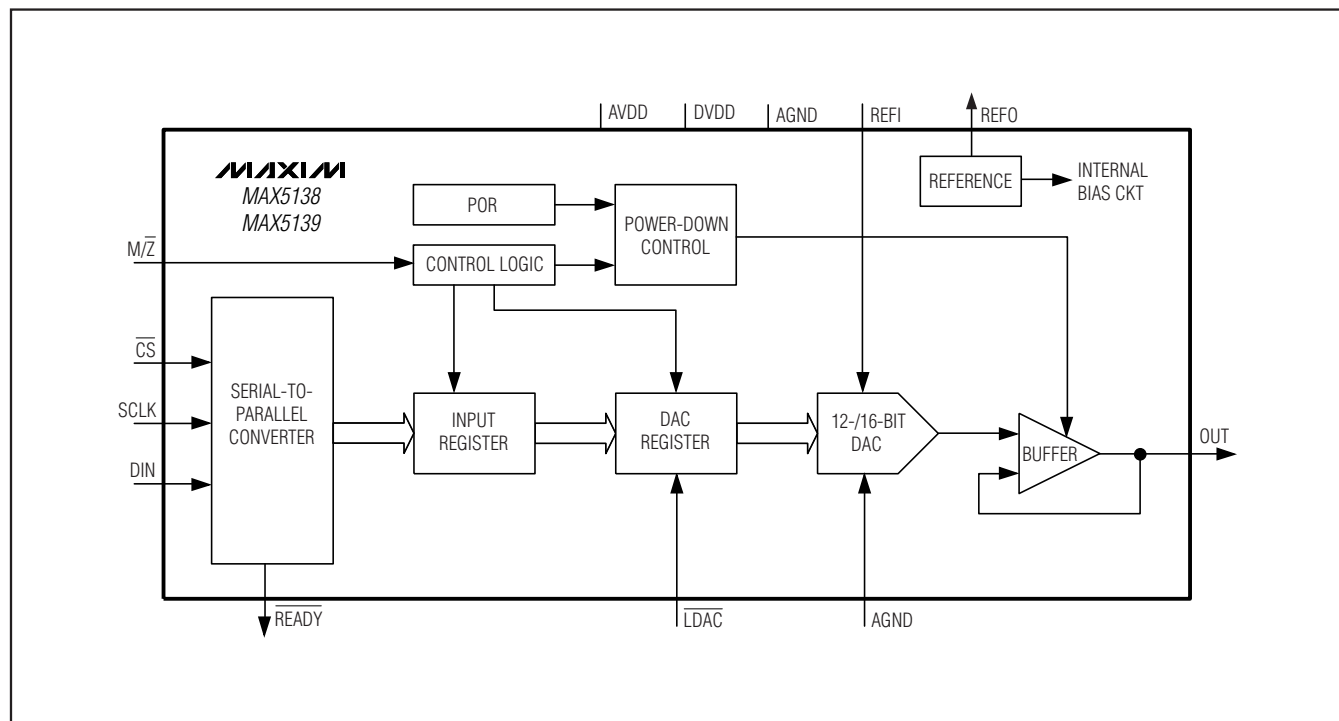

# Low-Power, Single, 16-/12-Bit, Buffered Voltage-Output DACs

## Typical Operating Circuit

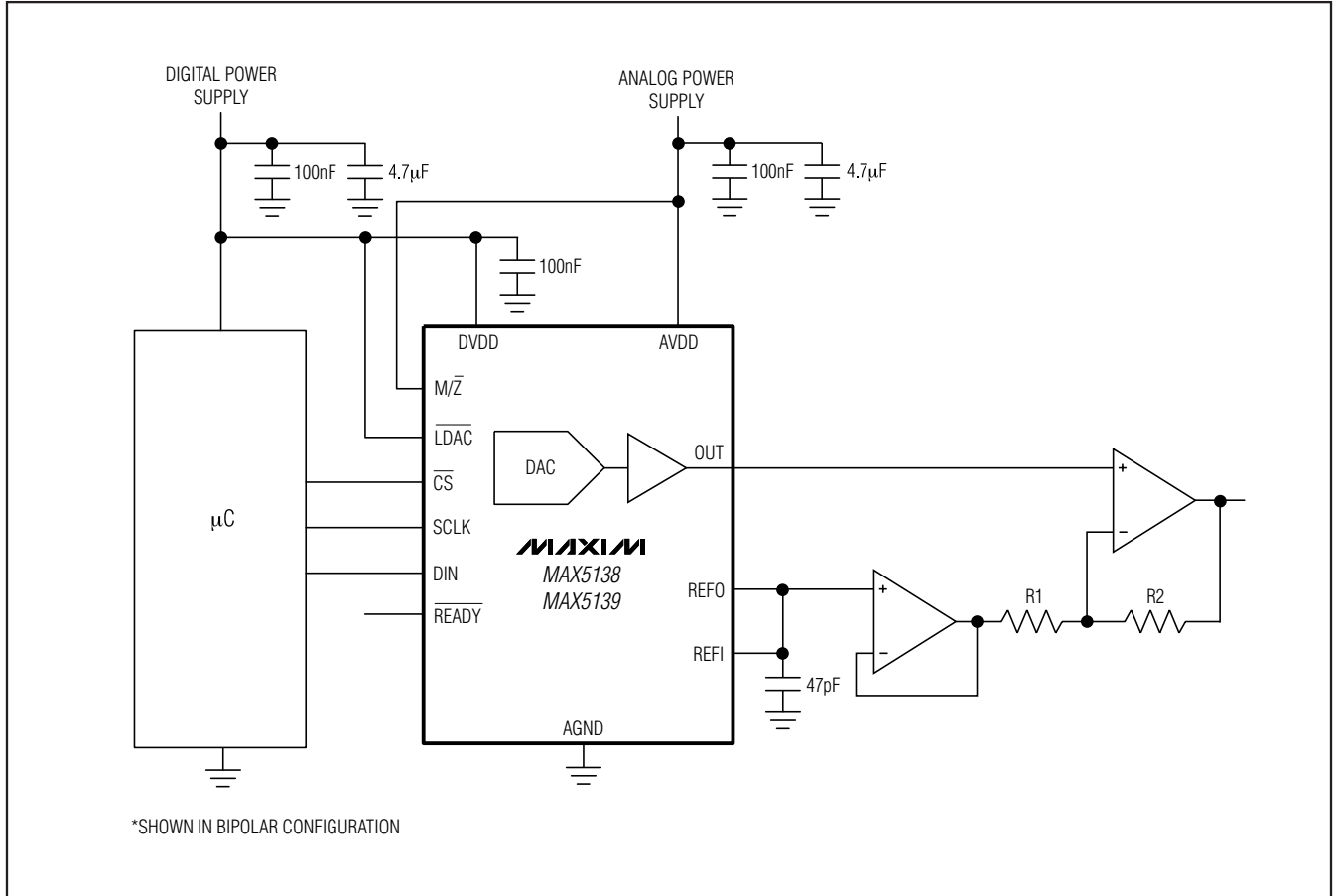

### Package Information

For the latest package outline information and land patterns, go to [www.maxim-ic.com/packages](http://www.maxim-ic.com/packages).

PACKAGE TYPE	PACKAGE CODE	DOCUMENT NO.
16 TQFN-EP	T1633-5	<a href="#">21-0136</a>



# Low-Power, Single, 16-/12-Bit, Buffered Voltage-Output DACs

## Revision History

REVISION NUMBER	REVISION DATE	DESCRIPTION	PAGES CHANGED
0	3/09	Initial release	—
1	4/09	Removed future product reference for MAX5139	1

**MAX5138/MAX5139**

Maxim cannot assume responsibility for use of any circuitry other than circuitry entirely embodied in a Maxim product. No circuit patent licenses are implied. Maxim reserves the right to change the circuitry and specifications without notice at any time.

**Maxim Integrated Products, 120 San Gabriel Drive, Sunnyvale, CA 94086 408-737-7600** \_\_\_\_\_ 17