



Spec. No.	PS-DS-S56124/S56125A9
Rev.	A

# PRODUCT SPECIFICATION

**Model No:CSS-S56124A9/S56125A9**

## Descriptions:

- 0.56 Inch Single Digit SMD Display
- Emitting Color : Super Bright Amber



CUSTOMER APPROVED SIGNATURES	APPROVED BY	CHECKED BY	PREPARED BY

**CHINA SEMICONDUCTOR CORPORATION**  
Address:2FL. NO.909,Chung-Cheng Road,  
Chung-Ho City Taipei Hsien,Taiwan.

Tel:886-2-2223-9696  
Fax:886-2-2223-9377

**OPTO PLUS TECHNOLOGIES CO.,LTD**  
Address:696 Shun jiang Rd.,Ji Shan St.Shaoxing,  
ZheJiang,China

Tel:86-0575-88623888  
Fax:86-0575-88623112



**Model No : CSS-S56124/S56125A9**

**Features -**

1. 0.56 inch (14.2mm) digit height.
2. Qualified according to JEDEC moisture sensitivity Level 2a.
3. RoHS compliant.
4. Low power consumption.
5. Easy mounting on P.C. board.

**Device Selection Guide -**

Model No.	Chip		Description
	Material	Emitting Color	
CSS-S56124A9	AlGaInP	Super Bright Amber	Common Anode
CSS-S56125A9	AlGaInP	Super Bright Amber	Common Cathode

**Mechanical Dimensions -**

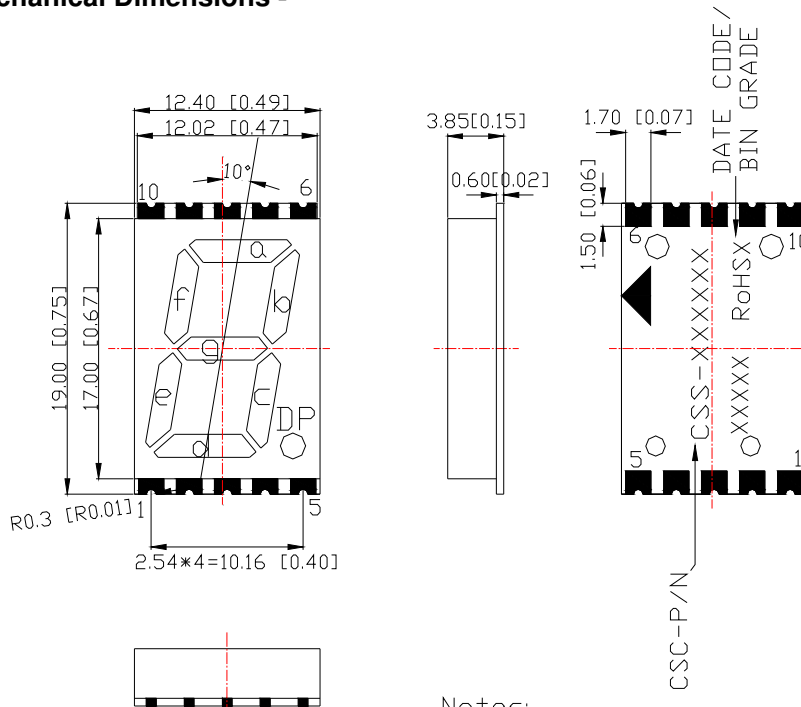

Notes:

All dimensions are in millimeters [inches],  
and tolerance is  $\pm 0.25$  [0.010]  
unless otherwise noted.



Model No : CSS-S56124/S56125A9

Internal Circuit Diagrams -

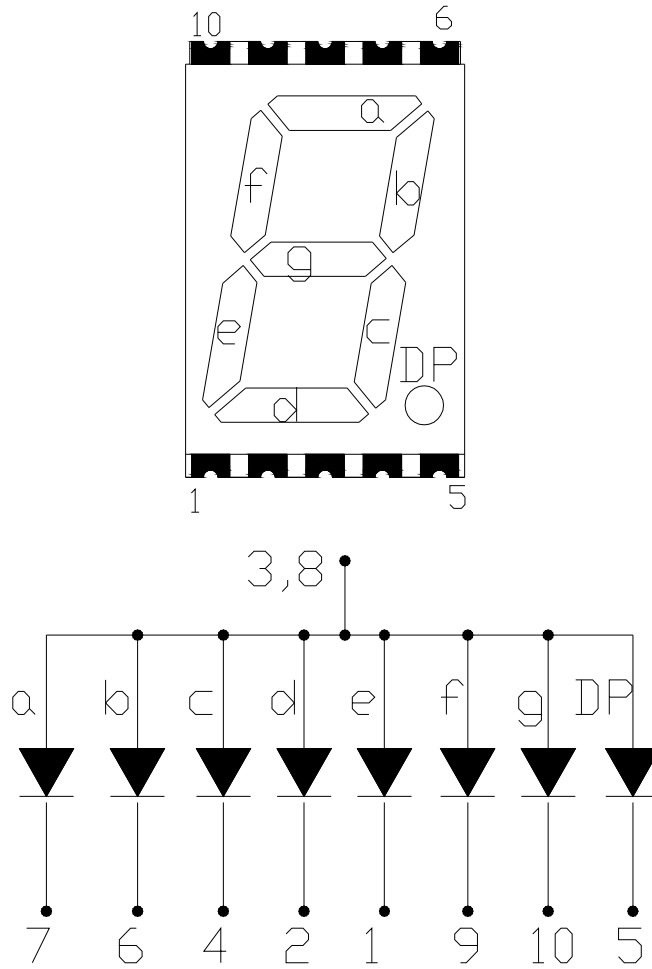

CSS-S56124 Common Anode  
(CSS-S56125 Common Cathode)



Model No : CSS-S56124/S56125A9

■ Absolute Maximum Rating -

(Ta=25°C)

Parameter	Symbol	Rating	Unit
Power Dissipation Per Dice	P <sub>AD</sub>	70	mW
Continuous Forward Current Per Dice	I <sub>AF</sub>	25	mA
Peak Current Per Dice(duty cycle 1/10,1KHz)	I <sub>PF</sub>	90	mA
Derating Linear From 25°C Per Dice	-	0.33	mA/°C
Reverse Voltage Per Dice	V <sub>R</sub>	5	V
Operating Temp.	T <sub>opr</sub>	-40 ~ +105	°C
Storage Temp.	T <sub>stg</sub>	-40 ~ +105	°C

Note:Solder temperature 1/16 inch below seating plane for 3 seconds at 260°C

■ Electro-optical Characteristics -

(Ta=25°C)

Parameter	Symbol	Min.	Typ.	Max.	Unit	Condition
Forward Voltage Per Segment	V <sub>F</sub>	-	2.0	2.8	V	I <sub>F</sub> =20mA
Luminous Intensity Per Segment	I <sub>v</sub>	8	20	-	mcd	I <sub>F</sub> =10mA
Peak Emission Wavelength	λ <sub>P</sub>	-	612	-	nm	I <sub>F</sub> =20mA
Spectrum Radiation Bandwidth	Δλ	-	20	-	nm	I <sub>F</sub> =20mA
Reverse Current	I <sub>R</sub>	-	-	100	μA	V <sub>R</sub> =5V
Luminous Intensity Matching Ratio	I <sub>V-m</sub>	-	-	2:1	-	I <sub>F</sub> =10mA



**Model No : CSS-S56124/S56125A9**

**Typical Electrical / Optical Characteristics Curves -**

**(Ta = 25°C Unless Otherwise Noted)**

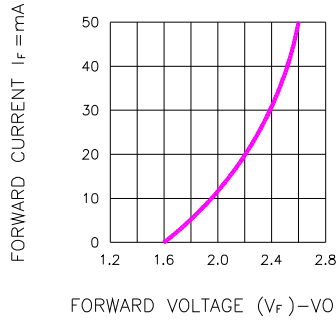

Fig.1 FORWARD CURRENT VS. FORWARD VOLTAGE

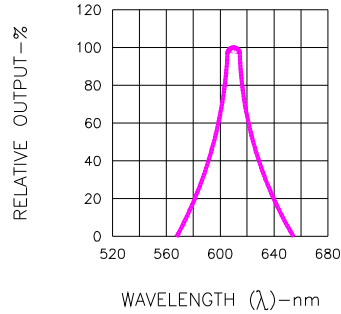

Fig.2 SPECTRAL RESPONSE

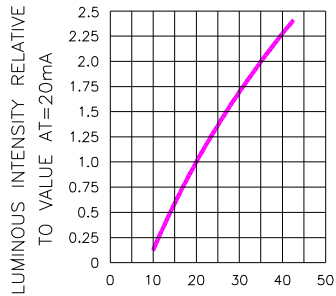

Fig.3 RELATIVE LUMINOUS INTENSITY VS. FORWARD CURRENT

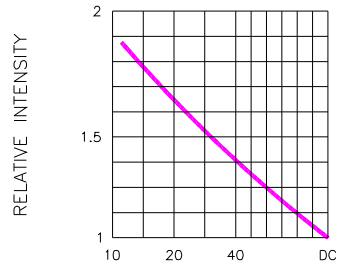

Fig.5 LUMINOUS INTENSITY VS. DUTY CYCLE

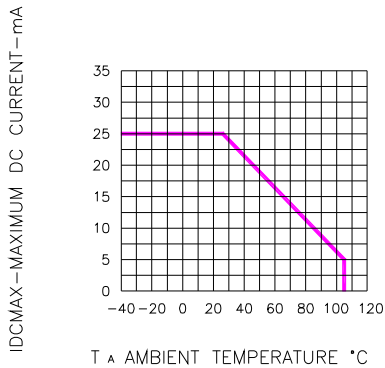

Fig.4 MAXIMUM ALLOWABLE DC CURRENT PER SEGMENT VS. A FUNCTION OF AMBIENT TEMPERATURE

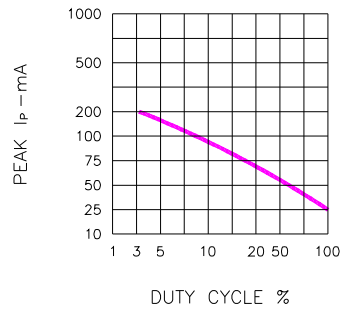

Fig.6 MAX PEAK CURRENT VS. DUTY CYCLE % (REFRESH RATE f=1 KHz)



Model No : CSS-S56124/S56125A9

## SMT REFLOW SOLDERING INSTRUCTIONS

### IR Reflow Temperature / Time :

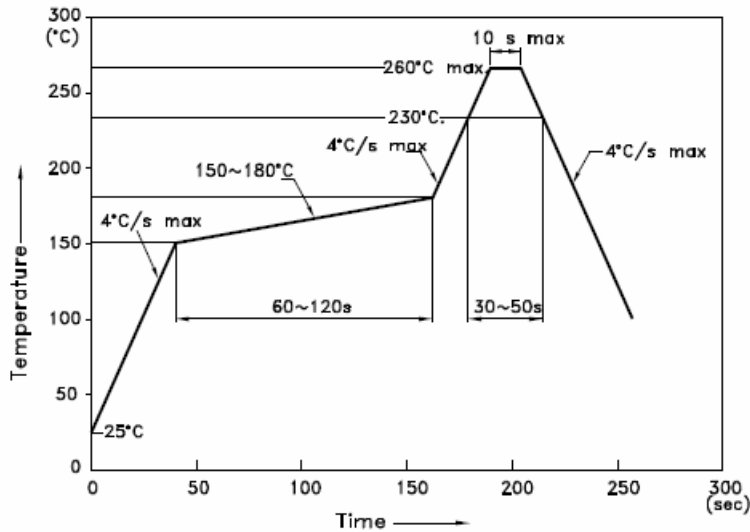

#### NOTES:

1. We recommend the reflow temperature 245°C(+/-5°C). The maximum soldering temperature should be limited to 260°C.
2. Don't cause stress to the epoxy resin while it is exposed to high temperature.
3. Number of reflow process shall be 2 times or less.

### Soldering Pad Size

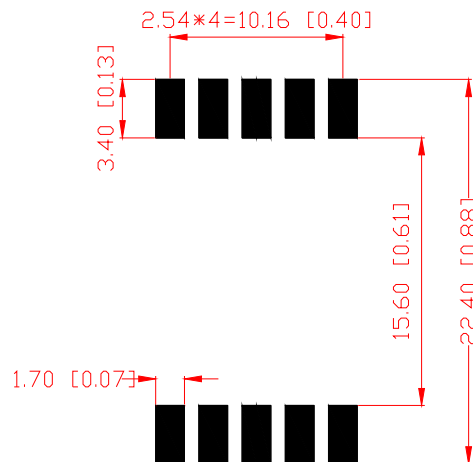



Model No : CSS-S56124/S56125A9

### REEL DIMENSIONS

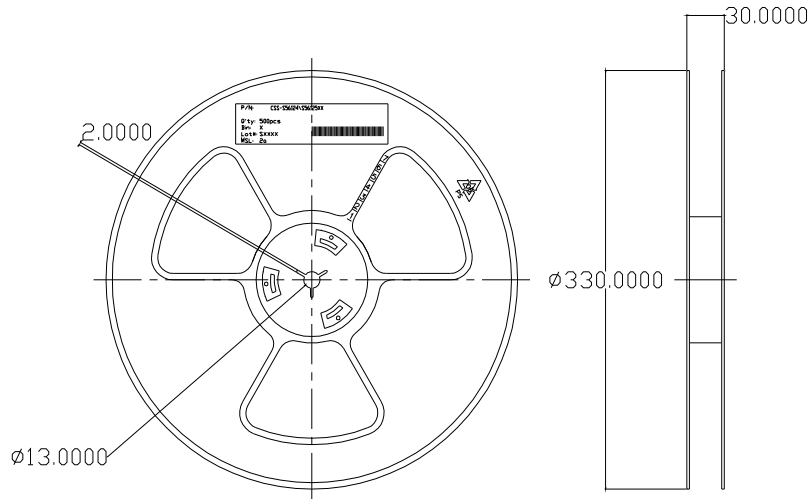

### PACKING & LABEL SPECIFICATIONS

