

# MFL Single and Dual DC/DC Converters

## 28 VOLT INPUT – 65 WATT

### FEATURES

- $-55^{\circ}$  to  $+125^{\circ}\text{C}$  operation
- 16 to 40 VDC input
- Fully Isolated
- Magnetic feedback
- Fixed frequency, 600 kHz typical
- Topology – Single Ended Forward
- 50 V for up to 120 ms transient protection
- Inhibit (input & output side)
- Sync function (in and out)
- Output trim on single output models
- Indefinite short circuit protection
- Remote sense on single output models
- Up to 87% efficiency / 43 W/in<sup>3</sup>
- Parallelable up to 148 watts



### MODELS

#### VDC OUTPUT

SINGLE	DUAL
3.3	$\pm 5$
5	$\pm 12$
12	$\pm 15$
15	
28	

Other output voltages available upon request, including 2 V, 8 V and 54 V single.

### DESCRIPTION

The MFL Series™ 28-volt DC/DC converters are rated up to 65 watts of output power over a  $-55^{\circ}\text{C}$  to  $+125^{\circ}\text{C}$  temperature range with a 28 VDC nominal input. On dual output models up to 70% of the rated output power can be drawn from either the positive or negative output. Current sharing allows the units to be paralleled for total power of up to 148 watts. The welded, hermetically sealed package is only 3.005 x 1.505 x 0.400 inches, giving the series an overall power density of up to 43 watts per cubic inch.

### DESIGN FEATURES

The MFL Series converters are switching regulators that use a quasi-square wave, single ended forward converter design with a constant switching frequency of 600 kHz.

Isolation between input and output circuits is provided with a transformer in the forward path and a wide bandwidth magnetic coupling in the feedback control loop. The MFL uses a unique dual loop feedback technique that controls output current with an inner feedback loop and an output voltage with a cascaded voltage mode feedback loop.

The additional secondary current mode feedback loop improves transient response in a manner similar to primary current mode control and allows for ease of paralleling, but without the cost and complexity.

The constant frequency, pulse-width modulated converters use a quasi-square wave single-ended forward design. Tight load regulation is achieved through a wide-bandwidth magnetic feedback circuit. The output on single MFL models can be trimmed (see Figure 1 for voltage changes with different resistor values).

### INHIBIT

The MFL Series converters have two TTL compatible inhibit terminals (INH1 and INH2) that can be used to disable power conversion, resulting in a very low quiescent input current and no generation of switching noise. An open collector TTL compatible low ( $<0.8$  volts) is required to inhibit the converter between INH1 (pin 4) and Input Common (pin 2). An open collector TTL compatible low ( $<0.5$  volts) is required to inhibit the converter between INH2 (pin 12) and Output Common (pin 8). The application of intermediate voltages to these pins (1.5 to 10.5 volts) should be avoided.

### SYNC

Converters may be synced to an external clock (525 to 675 kHz) or to one another by using the sync in or out pins. The nominal free-run switching frequency is 600 kHz.

### CURRENT AND PARALLEL OPERATION

Multiple MFL converters may be used in parallel to drive a common load (see Figure 2). In this mode of operation the load current is shared by two or three MFL converters. In current sharing mode, one MFL converter is designated as a master. The SLAVE pin (pin 11) of the master is left unconnected and the MSTR/INH2 pin (pin 12) of the master is connected to the SLAVE pin (pin 11) of the slave units. The units designated as slaves have the MSTR/INH2 pin (pin 12) connected to the SNS RTN pin (pin 9). Figure 2 shows the typical setup for two or three units in parallel. Note that synchronizing the units together (though shown in the figure) is not required for current sharing operation. A second slave unit may be placed in parallel with a master and slave; this requires the TRI pin (pin 3) of the master unit to be connected to the SNS RTN pin (pin 9).

When paralleled, 76% of the total combined power ratings of the MFL converters are available at the load. Overload and short circuit performance are not adversely affected during parallel operation.

# MFL Single and Dual DC/DC Converters

## 28 VOLT INPUT – 65 WATT

### OPERATING CONDITIONS AND CHARACTERISTICS

#### Input Voltage Range

- 16 to 40 VDC continuous
- 50 V for 120 msec transient

#### Output Power

- 50 to 65 watts depending on model

#### Lead Soldering Temperature (10 sec per lead)

- 300°C

#### Storage Temperature Range (Case)

- -65°C to +150°C

#### Power Dissipation (Pd)

- 14 watts (16 watts MFL2805S, MFL2805D)

#### Case Operating Temperature (Tc)

- -55°C to +125°C full power
- -55°C to +135°C absolute

#### Derate Output Power/Current

- Linearly from 100% at 125°C to 0% at 135°C
- MFL283R3S: linearly from 100% at 100°C to 80% at 125°C and to 0% at 135°C

#### Output Voltage Temperature Coefficient

- 100 ppm/°C typical

#### Input to Output Capacitance

- 150 pF, typical

#### Current Limit

- 125% of full load typical

#### Isolation

- 100 megohm minimum at 500 V

#### Audio Rejection

- 50 dB typical

#### Conversion Frequency (-55°C to 125°C)

- Free run mode 600 kHz typical  
525 kHz. min, 675 kHz max

#### Inhibit Pin Voltage (unit enabled)

- INH1 = 9 to 12 V, INH2 = 6 to 9 V

### SYNC AND INHIBIT (INH1, INH2)

#### Sync In (525 to 675 kHz)

- Duty cycle 40% min, 60% max
- Logic low 0.8 V max
- Logic high 4.5 V min, 5 V max
- Referenced to input common

#### Sync Out

- Referenced to input common

#### Inhibit (INH1, INH2) TTL Open Collector

- Logic low (output disabled)
  - INH1 referenced to input common
    - Logic low 0.8 V max
    - Inhibit pin current 10 mA max
  - INH2 referenced to output common
    - Logic low 0.5 V max
    - Inhibit pin current 5 mA max
- Logic high (output enabled)
  - Open collector

### MECHANICAL AND ENVIRONMENTAL

#### Size (maximum)

- 3.005 x 1.505 x 0.400 inches (76.33 x 38.23 x 10.16 mm)
- See case U for dimensions.
- Case options V, W, Y and Z are available by special order.

#### Weight (maximum)

- 86 grams

#### Screening

- Standard, ES, or /883 (Class H, QML). See "883, Class H, QML Products – Element Evaluation" and "883, Class H, QML Products – Environmental Screening" for more information.

# MFL Single and Dual DC/DC Converters

## 28 VOLT INPUT – 65 WATT

PIN OUT				PINS NOT IN USE	
Pin	Single Output	MFL2828S	Dual Output		
1	Positive Input	Positive Input	Positive Input	TR1	Leave unconnected
2	Input Common	Input Common	Input Common	Master	Leave unconnected
3	Triple (TRI)	Triple (TRI)	Triple (TRI)	Slave	Leave unconnected
4	Inhibit 1 (INH1)	Inhibit 1 (INH1)	Inhibit 1 (INH1)	Sync in	Connect to input common
5	Sync Out	Sync Out	Sync Out	Inhibit (INH1)	Leave unconnected
6	Sync In	Sync In	Sync In	Inhibit (INH2)	Leave unconnected
7	Positive Output	Positive Output	Positive Output	Sync Out	Leave unconnected
8	Output Common	No connection	Output Common	Sense Lines	Must be connected to appropriate outputs
9	Sense Return	Output Common	Negative Output		
10	Positive Sense	No connection	No connection		
11	Slave	Slave	Slave		
12	Master/ Inhibit 2	Master/ Inhibit 2	Master / Inhibit 2		

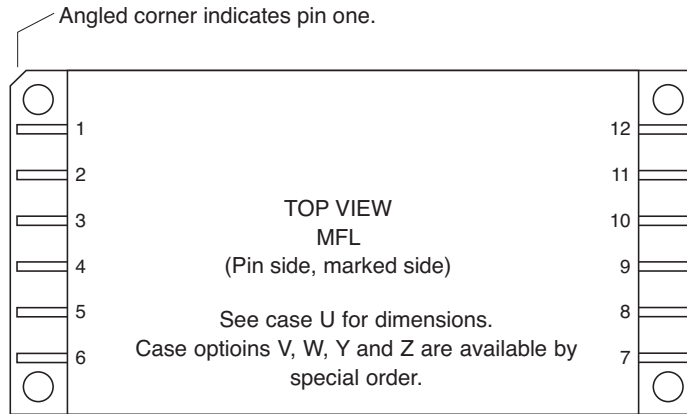

**FIGURE 1: PIN OUT**

# MFL Single and Dual DC/DC Converters

## 28 VOLT INPUT – 65 WATT

### SINGLE OUTPUT MODELS CONNECTION DIAGRAMS - SENSE AND PARALLEL

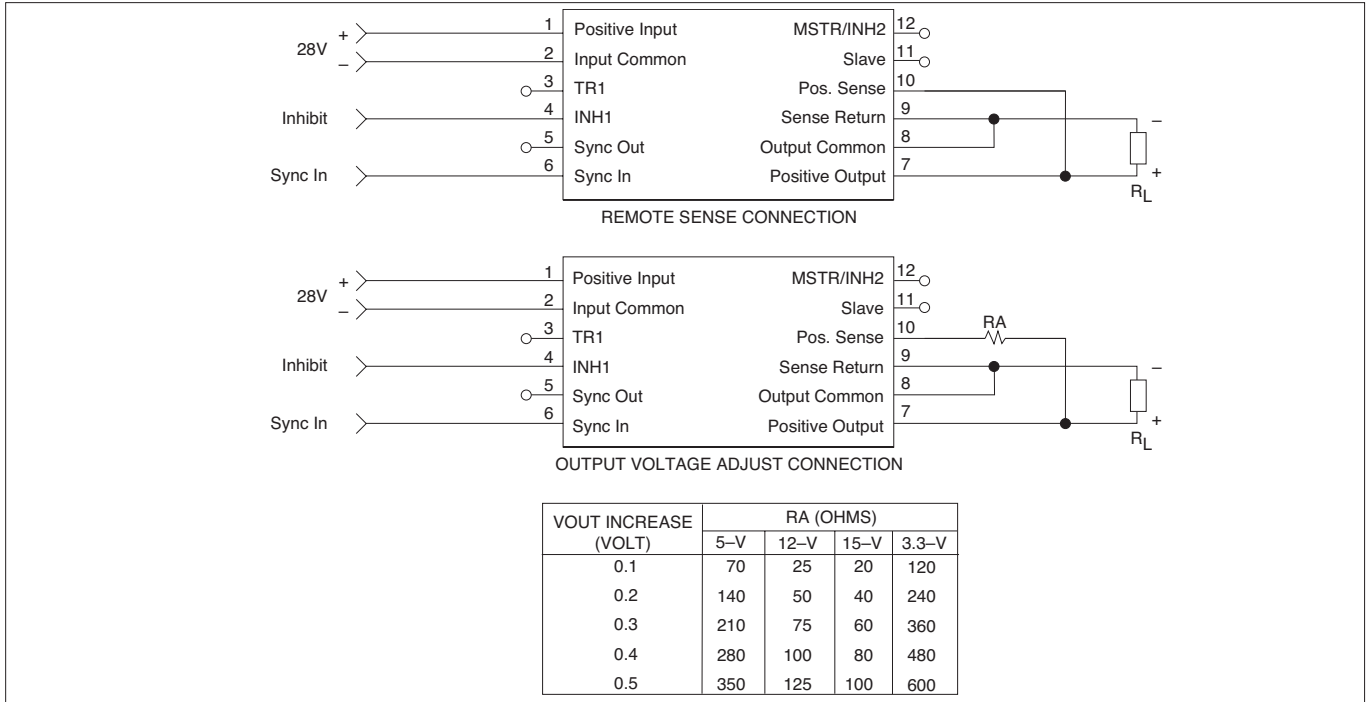

FIGURE 2: SENSE CONNECTIONS AND TRIM TABLE

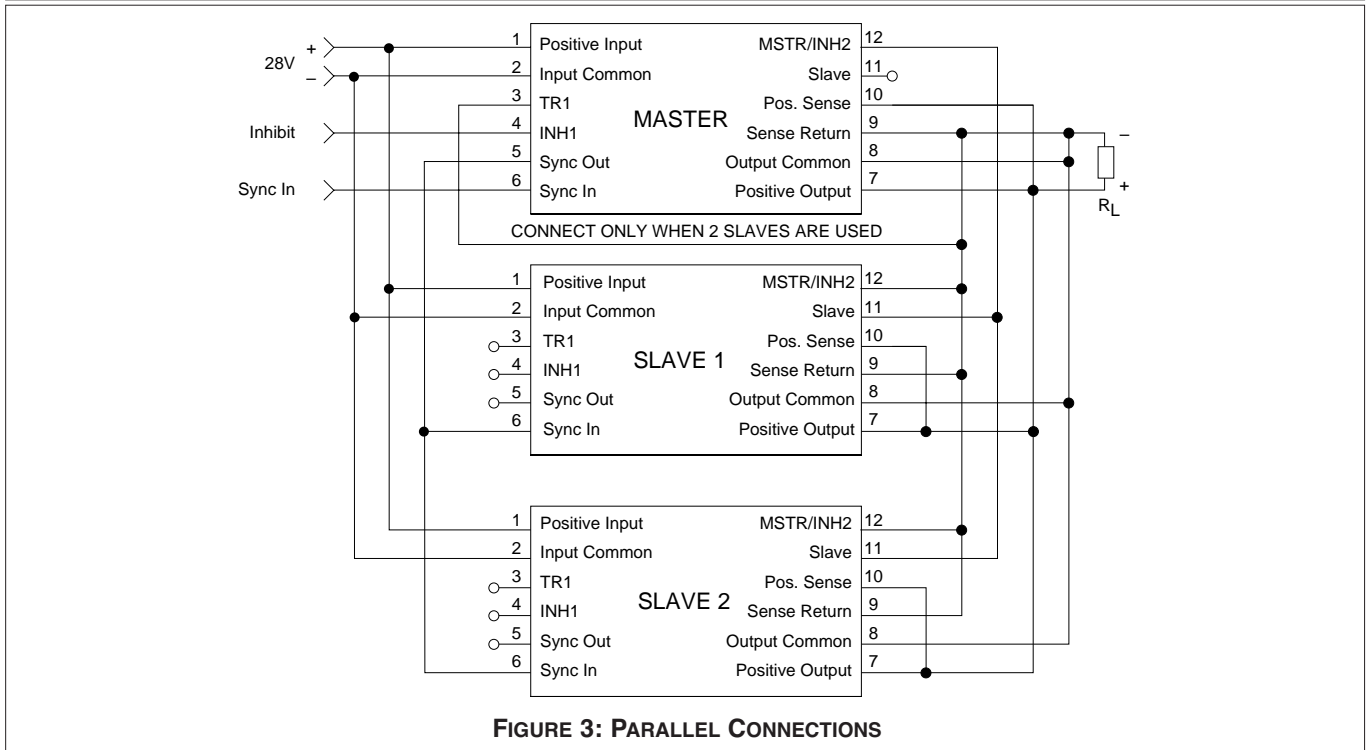
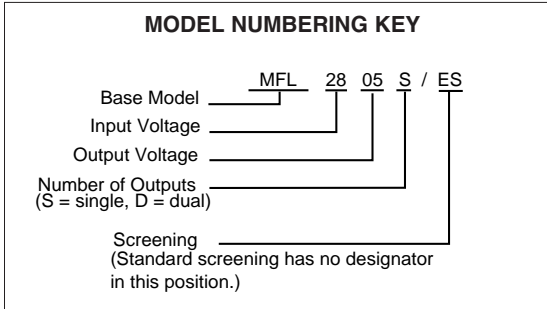

FIGURE 3: PARALLEL CONNECTIONS

# MFL Single and Dual DC/DC Converters

## 28 VOLT INPUT – 65 WATT



SMD NUMBERS	
STANDARD MICROCIRCUIT DRAWING (SMD)	MFL SERIES SIMILAR PART
IN PROCESS	MFL283R3S
5962-9316301HXC	MFL2805S/883
5962-9316201HXC	MFL2812S/883
5962-9316101HXC	MFL2815S/883
IN PROCESS	MFL2828S/883
5962-9319101HXC	MFL2805D/883
5962-9319201HXC	MFL2812D/883
5962-9319301HXC	MFL2815D/883

For exact specifications for an SMD product, refer to the SMD drawing. SMDs can be downloaded from:  
<http://www.dscc.dla.mil/programs/smcr>

### Model Selection

**MFL28**

\_\_\_\_\_
\_\_\_\_\_
\_\_\_\_\_

*Base model*                      *Vout value*                      *number of outputs*                      *screening*

Choose one from each of the following rows

**Vout value**                      for singles: 3R3, 5, 12, 15, 28                      for duals: 5, 12, 15

---

"R" = decimal point, 3R3 = 3.3VDC

---

**Number of outputs**                      S (single) or D (dual)

---

**Screening**                      standard screening, leave blank                      /ES (ES screening), /883 (Class H, QML)

# MFL Single and Dual DC/DC Converters

## 28 VOLT INPUT – 65 WATT

Electrical Characteristics: –55°C to +125°C Tc, 28 VDC Vin, 100% load, free run, unless otherwise specified.

SINGLE OUTPUT MODELS		MFL283R3S			MFL2805S			MFL2812S			UNITS
PARAMETER	CONDITION	MIN	TYP	MAX	MIN	TYP	MAX	MIN	TYP	MAX	
OUTPUT VOLTAGE	Tc = 25°C	3.26	3.3	3.34	4.95	5.00	5.05	11.88	12.00	12.12	VDC
OUTPUT CURRENT	V <sub>IN</sub> = 16 TO 40 VDC	0	–	12.12 <sup>2</sup>	0	–	10	0	–	5	A
OUTPUT POWER	V <sub>IN</sub> = 16 TO 40 VDC	0	–	40 <sup>2</sup>	0	–	50	0	–	60	W
OUTPUT RIPPLE	Tc = 25°C	–	10	35	–	15	35	–	30	75	mV p-p
VOLTAGE 10 k - 2 MHz	Tc = –55°C to +125°C	–	10	50	–	30	50	–	45	100	
LINE REGULATION	V <sub>IN</sub> = 16 to 40 VDC	–	0	20	–	0	20	–	0	20	mV
LOAD REGULATION	NO LOAD TO FULL	–	–	40	–	–	20	–	–	20	mV
INPUT VOLTAGE	CONTINUOUS	16	28	40	16	28	40	16	28	40	VDC
NO LOAD TO FULL	TRANSIENT <sup>1, 3</sup> 50 ms	–	–	50	–	–	50	–	–	50	V
INPUT CURRENT	NO LOAD	–	70	100	–	70	120	–	50	100	mA
	INHIBITED - INH1	–	9	14	–	9	14	–	9	14	mA
	INHIBITED - INH2	–	35	70	–	35	70	–	35	70	
INPUT RIPPLE CURRENT	10 kHz - 10 MHz	–	15	50	–	15	50	–	15	50	mA pp
EFFICIENCY	Tc = 25°C	73	–	–	77	80	–	83	86	–	%
LOAD FAULT	POWER DISSIPATION SHORT CIRCUIT										
	Tc = 25°C	–	12.5	20	–	12.5	16	–	10	14	W
	RECOVERY <sup>1</sup>	–	1.5	4	–	1.5	4	–	1.5	4	ms
STEP LOAD RESP.	50% – 100% – 50%										
	TRANSIENT	–	200	400	–	250	350	–	450	600	mV pk
	RECOVERY <sup>1, 4</sup>	–	1.5	3.0	–	1.5	3.0	–	1.5	3.0	ms
STEP LINE RESP.	16 – 40 – 16 VDC										
	TRANSIENT <sup>1, 5</sup>	–	250	300	–	250	300	–	250	400	mV pk
	RECOVERY <sup>1, 4</sup>	–	200	600	–	200	300	–	200	300	μs
START-UP <sup>6</sup>	DELAY	–	3.5	6	–	3.5	6	–	3.5	6	ms
	OVERSHOOT <sup>1</sup>	–	0	25	–	0	25	–	0	50	mV pk
C <sub>OUT</sub>	Tc=25°C <sup>1, 7</sup>	–	–	1000	–	–	1000	–	–	1000	μF

### Notes

1. Guaranteed by design, not tested.
2. MFL283R3S current and power maximum are at 25°C only.
3. Unit will shut down above approximately 45V but will be undamaged and will restart when voltage drops into normal range.
4. Recovery time is measured from application of the transient to point at which V<sub>out</sub> is within 1% of final value.
5. Transition time ≥ 10 μs.
6. Tested on release from inhibit.
7. Shall not compromise DC performance

# MFL Single and Dual DC/DC Converters

## 28 VOLT INPUT – 65 WATT

Electrical Characteristics: –55°C to +125°C Tc, 28 VDC Vin, 100% load, free run, unless otherwise specified.

SINGLE OUTPUT MODELS		MFL2815S			MFL2828S <sup>2</sup>			UNITS
PARAMETER	CONDITION	MIN	TYP	MAX	MIN	TYP	MAX <sup>2</sup>	
OUTPUT VOLTAGE	Tc = 25°C	14.85	15.00	15.15	27.72	28.00	28.28	VDC
OUTPUT CURRENT	V <sub>IN</sub> = 16 TO 40 VDC	0	–	4.33	0	–	2.32	A
OUTPUT POWER	V <sub>IN</sub> = 16 TO 40 VDC	0	–	65	0	–	65	W
OUTPUT RIPPLE	Tc = 25°C	–	30	85	–	100	200	mV p-p
VOLTAGE 10 k - 2 MHz	Tc = –55°C to +125°C	–	45	110	–	–	–	
LINE REGULATION	V <sub>IN</sub> = 16 to 40 VDC	–	0	20	–	20	60	mV
LOAD REGULATION	NO LOAD TO FULL	–	0	20	–	20	75	mV
INPUT VOLTAGE	CONTINUOUS	16	28	40	16	28	40	VDC
NO LOAD TO FULL	TRANSIENT <sup>1, 3</sup> 50 ms	–	–	50	–	–	50	V
INPUT CURRENT	NO LOAD	–	50	100	–	60	100	mA
	INHIBITED - INH1	–	9	14	–	9	14	
	INHIBITED - INH2	–	35	70	–	35	70	
INPUT RIPPLE CURRENT	10 kHz - 10 MHz	–	15	50	–	20	50	mA pp
EFFICIENCY	Tc = 25°C	84	87	–	83	86	–	%
LOAD FAULT	POWER DISSIPATION SHORT CIRCUIT Tc = 25°C	–	10	14	–	7	14	W
	RECOVERY <sup>1</sup>	–	1.5	4	–	1.0	4	ms
STEP LOAD RESP.	50% – 100% – 50% TRANSIENT	–	500	600	–	800	1400	mV pk
	RECOVERY <sup>1, 4</sup>	–	1.5	3.0	–	1.5	3.0	ms
STEP LINE RESP.	16 – 40 – 16 VDC TRANSIENT <sup>1, 5</sup>	–	250	400	–	250	800	mV pk
	RECOVERY <sup>1, 4</sup>	–	200	300	–	200	400	μs
START-UP <sup>6</sup>	DELAY	–	3.5	6	–	3.5	6	ms
	OVERSHOOT <sup>1,</sup>	–	0	50	–	0	100	mV pk
C <sub>OUT</sub>	Tc=25°C <sup>1, 7</sup>	–	–	1000	–	–	1000	μF

### Notes

1. Guaranteed by design, not tested.
2. MFL2828S specifications are at 25°C.
3. Unit will shut down above approximately 45V but will be undamaged and will restart when voltage drops into normal range.
4. Recovery time is measured from application of the transient to point at which V<sub>out</sub> is within 1% of final value.
5. Transition time ≥ 10 μs.
6. Tested on release from inhibit.
7. Shall not compromise DC performance

# MFL Single and Dual DC/DC Converters

## 28 VOLT INPUT – 65 WATT

Electrical Characteristics: –55°C to +125° C Tc, 28 VDC Vin, 100% load, free run, unless otherwise specified.

DUAL OUTPUT MODELS		MFL2805D			MFL2812D			MFL2815D			UNITS
PARAMETER	CONDITIONS	MIN	TYP	MAX	MIN	TYP	MAX	MIN	TYP	MAX	
OUTPUT VOLTAGE	Tc = 25°C +V <sub>OUT</sub> -V <sub>OUT</sub>	4.95	5.00	5.05	11.88	12.00	12.12	14.85	15.00	15.15	VDC
		4.92	5.00	5.08	11.82	12.00	12.18	14.77	15.00	15.23	
OUTPUT CURRENT <sup>2</sup> V <sub>IN</sub> = 16 TO 40 VDC	EACH OUTPUT	0	—	7	0	—	3.5	0	—	3.03	A
	TOTAL OUTPUT	0	—	10	0	—	5	0	—	4.34	
OUTPUT POWER <sup>2</sup>	V <sub>IN</sub> = 16 TO 40 VDC	0	—	50	0	—	60	0	—	65	W
OUTPUT RIPPLE VOLTAGE +/- V <sub>OUT</sub>	10 kHz - 2 MHz	—	50	100	—	50	120	—	50	150	mV p-p
LINE REGULATION V <sub>IN</sub> = 16 TO 40 VDC	+V <sub>OUT</sub>	—	0	50	—	0	50	—	0	50	mV
	-V <sub>OUT</sub>	—	25	100	—	25	100	—	25	100	
LOAD REGULATION NO LOAD TO FULL	+V <sub>OUT</sub>	—	0	50	—	10	50	—	10	50	mV
	-V <sub>OUT</sub>	—	25	100	—	50	120	—	50	150	
CROSS REGULATION Tc = 25°C	SEE NOTE 3	—	5	8	—	2	4	—	2	4	%
	SEE NOTE 4	—	3	6	—	2	4	—	2	4	
INPUT VOLTAGE NO LOAD TO FULL	CONTINUOUS	16	28	40	16	28	40	16	28	40	VDC
	TRANSIENT <sup>1, 5</sup> 50 ms.	0	—	50	0	—	50	0	—	50	V
INPUT CURRENT	NO LOAD	—	50	120	—	50	100	—	50	100	mA
	INHIBITED - INH1	—	9	14	—	9	14	—	9	14	mA
	INHIBITED - INH2	—	35	70	—	35	70	—	35	70	
INPUT RIPPLE CURRENT	10 kHz - 10 MHz	—	15	50	—	15	50	—	15	50	mA p-p
EFFICIENCY 25°C Tc	BALANCED LOAD	77	80	—	83	86	—	84	87	—	%
LOAD FAULT	POWER DISSIPATION SHORT CIRCUIT Tc = 25°C	—	12.5	16	—	10	14	—	10	14	W
	RECOVERY <sup>1</sup>	—	1.5	4.0	—	1.5	4.0	—	1.5	4.0	ms
STEP LOAD RESP. ± V <sub>OUT</sub>	50 %-100%- 50% LOAD										
	TRANSIENT RECOVERY <sup>1, 6</sup>	—	250	350	—	450	600	—	500	600	mV pk ms
STEP LINE RESP. ± V <sub>OUT</sub>	16 - 40 - 16 V <sub>IN</sub> TRANSIENT <sup>1, 7</sup>	—	250	300	—	250	400	—	250	400	mV pk
	RECOVERY <sup>1, 6</sup>	—	200	300	—	200	300	—	200	300	μs
START-UP <sup>8</sup>	DELAY	—	3.5	6	—	3.5	6	—	3.5	6	ms
	OVERSHOOT <sup>1</sup>	—	0	25	—	0	50	—	0	50	mV p
C <sub>OUT</sub>	Tc=25°C <sup>1,9</sup>	—	—	500	—	—	500	—	—	500	μF

### Notes

**1. Guaranteed by design, not tested.**

- Up to 70% of the total output power is available from either output providing the opposite output is simultaneously carrying 30% of the total power.
- Effect on negative Vout from 50%/50% loads to 70%/30% or 30%/70% loads.
- Effect on negative Vout from 50%/50% loads to +Pout=50%, -Pout=10%.

- Unit will shut down above approximately 45V but will be undamaged and will restart when voltage drops into normal range.
- Recovery time is measured from application of the transient to point at which Vout is within 1% of final value.
- Transition time ≥ 10 μs.
- Tested on release from inhibit.
- Shall not compromise DC performance



# MFL Single and Dual DC/DC Converters

## 28 VOLT INPUT – 65 WATT

**Typical Performance Curves: 25°C Tc , 28 VDC Vin, 100% load, free run, unless otherwise specified.**

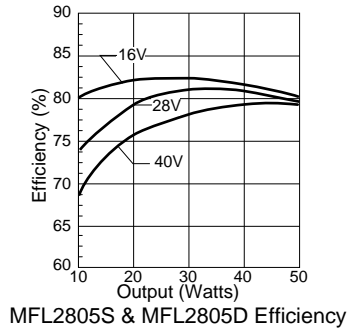

**FIGURE 4**

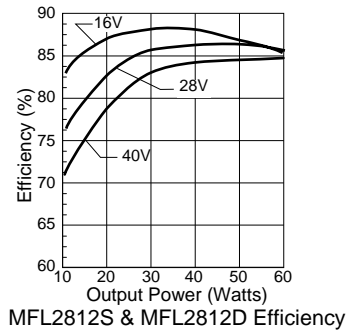

**FIGURE 5**

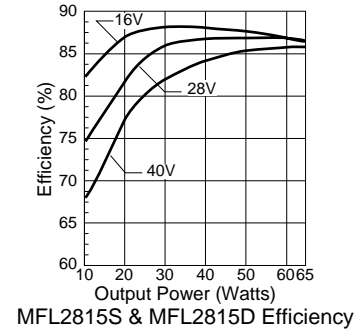

**FIGURE 6**

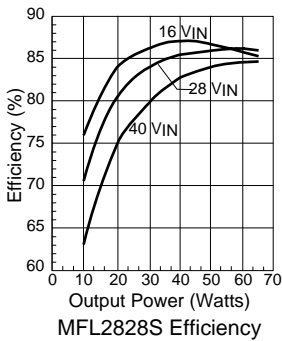

**FIGURE 7**

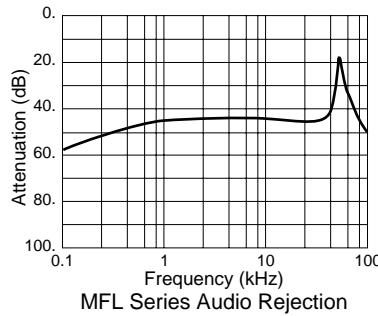

**FIGURE 8**

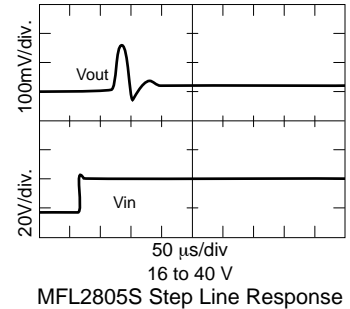

**FIGURE 9**

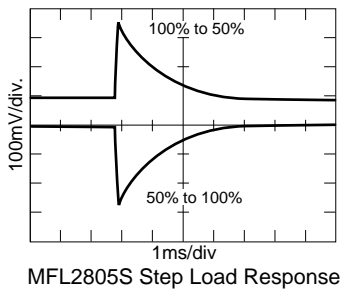

**FIGURE 10**

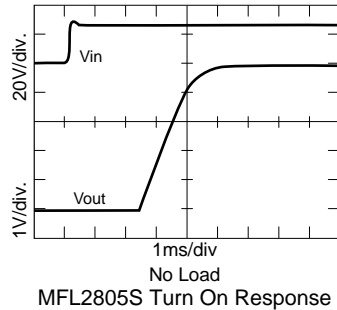

**FIGURE 11**

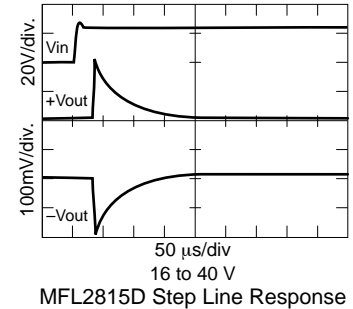
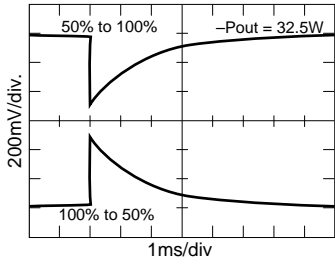

**FIGURE 12**

# MFL Single and Dual DC/DC Converters

## 28 VOLT INPUT – 65 WATT

Typical Performance Curves: 25°C Tc , 28 VDC Vin, 100% load, free run, unless otherwise specified.



MFL2815D Step Load Response

FIGURE 13

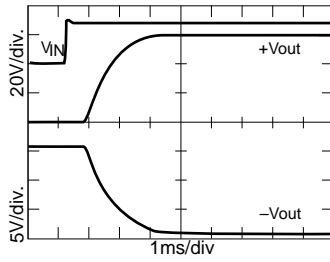

MFL2815D Turn On Response

FIGURE 14

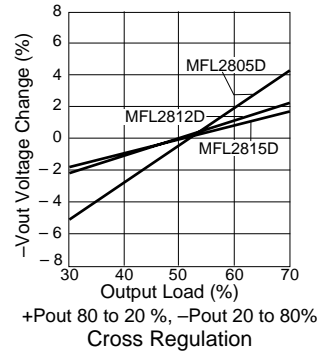

FIGURE 15

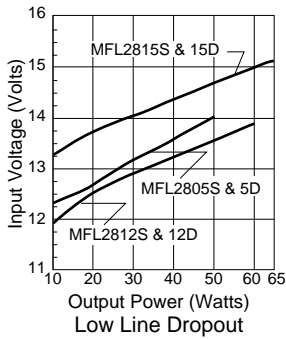

FIGURE 16

# MFL Single and Dual DC/DC Converter Cases

## 28 VOLT INPUT – 65 WATT

### TOP VIEW CASE U Flanged case, short-leaded

\*Does not require designator in Case Option position of model number.

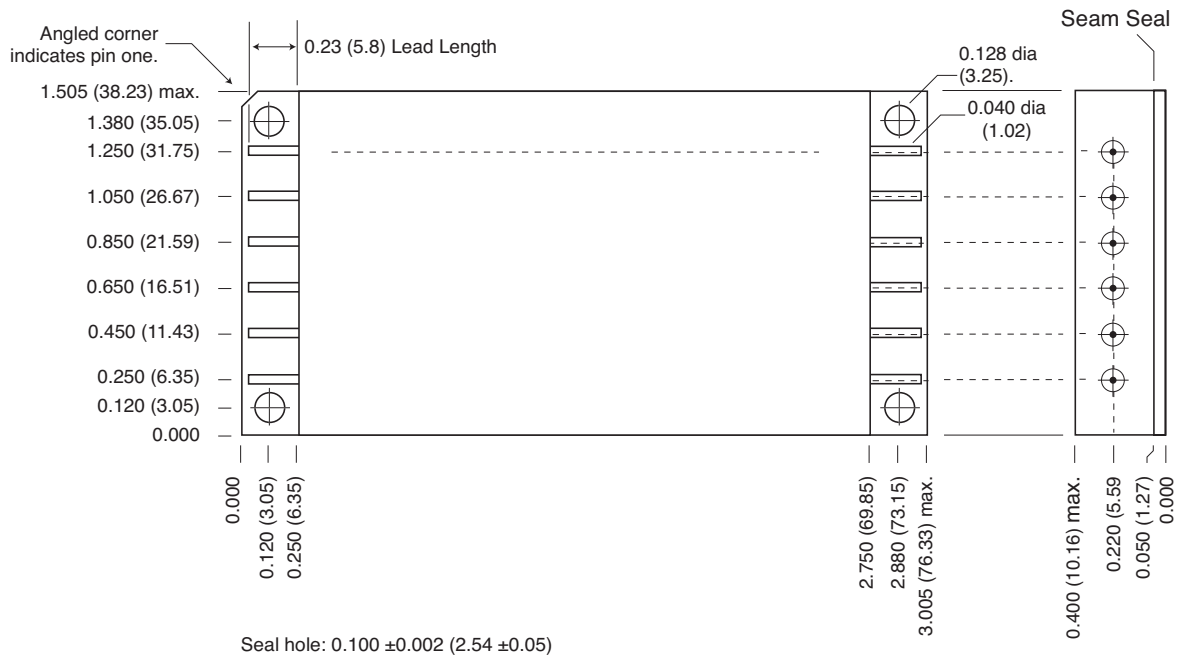

**Case dimensions in inches (mm)**

Tolerance ±0.005 (0.13) for three decimal places  
 ±0.01 (0.3) for two decimal places  
 unless otherwise specified

**CAUTION**

Heat from reflow or wave soldering may damage the device.  
 Solder pins individually with heat application not exceeding 300°C for 10 seconds per pin

**Materials**

Header Cold Rolled Steel/Nickel/Gold  
 Cover Kovar/Nickel  
 Pins #52 alloy/Gold; compression glass seal

Case U, Rev C, 20060302

Please refer to the numerical dimensions for accuracy. All information is believed to be accurate, but no responsibility is assumed for errors or omissions. Interpoint reserves the right to make changes in products or specifications without notice.

Copyright © 1999-2006 Interpoint Corp. All rights reserved.

**FIGURE 17: CASE U**

## MFL Single and Dual DC/DC Converters

28 VOLT INPUT – 65 WATT

### 883, CLASS H, QML PRODUCTS – ELEMENT EVALUATION

ELEMENT EVALUATION  TEST PERFORMED (COMPONENT LEVEL)	STANDARD (NON-QML) <sup>1</sup>		CLASS H, QML	
	M/S <sup>2</sup>	P <sup>3</sup>	M/S <sup>2</sup>	P <sup>3</sup>
Element Electrical (probe)	yes	no	yes	yes
Element Visual	no	no	yes	yes
Internal Visual	no	no	yes	no
Final Electrical	no	no	yes	yes
Wire Bond Evaluation <sup>4</sup>	no	no	yes	yes
SLAM™/C-SAM: Input Capacitors only (Add'l test, not req. by H or K)	no	no	no	yes

**Definitions:**

Element Evaluation: Component testing/screening per MIL-STD-883 as determined by MIL-PRF-38534

SLAM™: Scanning Laser Acoustic Microscopy

C-SAM: C - Mode Scanning Acoustic Microscopy

**Notes:**

1. Non-QML products do not meet all of the requirements of MIL-PRF-38534
2. M/S = Active components (Microcircuit and Semiconductor Die)
3. P = Passive components
4. Not applicable to EMI filters that have no wire bonds

# MFL Single and Dual DC/DC Converters

28 VOLT INPUT – 65 WATT

## 883, CLASS H, QML PRODUCTS – ENVIRONMENTAL SCREENING

TEST	125°C STANDARD non-QML	125°C /ES non-QML	Class H /883 QML
Pre-cap Inspection Method 2017, 2032	yes	yes	yes
Temperature Cycle (10 times) Method 1010, Cond. C, -65°C to 150°C, ambient Method 1010, Cond. B, -55°C to 125°C, ambient	no no	no yes	yes no
Constant Acceleration Method 2001, 3000 g Method 2001, 500g	no no	no yes	yes no
Burn-In Method 1015, 160 hours at 125°C case, typical 96 hours at 125°C case, typical	no no	no yes	yes no
Final Electrical Test MIL-PRF-38534, Group A Subgroups 1 through 6: -55°C, +25°C, +125°C case Subgroups 1 and 4: +25°C case	no yes	no yes	yes no
Hermeticity Test Fine Leak, Method 1014, Cond. A Gross Leak, Method 1014, Cond. C Gross Leak, Dip (1 x 10 <sup>-3</sup> )	no no yes	yes yes no	yes yes no
Final Visual Inspection Method 2009	yes	yes	yes

Test methods are referenced to MIL-STD-883 as determined by MIL-PRF-38534.