

SPECIFICATION FOR APPROVAL

REF : 20090626-A

PAGE: 1

PROD. NAME	SHIELDED SMD POWER INDUCTOR	ABC'S DWG NO.	SS1003□□□□L□-□□□
		ABC'S ITEM NO.	

I . CONFIGURATION & DIMENSIONS :

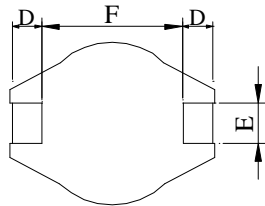
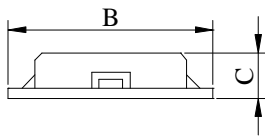
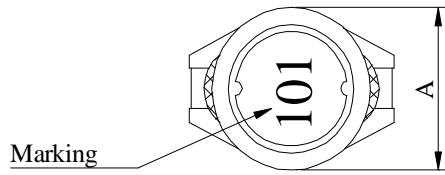

- A : 10.1±0.3 m/m
- B : 12.7±0.3 m/m
- C : 2.70±0.3 m/m
- D : 2.40±0.2 m/m
- E : 2.20 ref. m/m
- F : 7.60±0.3 m/m
- G : 7.30 ref. m/m
- H : 2.80 ref. m/m
- I : 3.00 ref. m/m

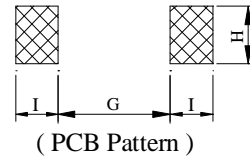

II . SCHEMATIC DIAGRAM :



III . MATERIALS :

- a . Core : Ferrite DR core
- b . Core : Ferrite RI core
- c . Wire : Enamelled copper wire (class F)
- d . Base : LCP E4008
- e . Terminal : Cu/Ni/Sn
- f . Adhesive : Epoxy resin
- g . Remark : Products comply with RoHS' requirements

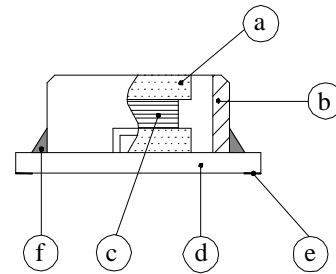

Peak Temp : 260°C max.
 Max time above 230°C : 50sec max.
 Max time above 200°C : 70sec max.

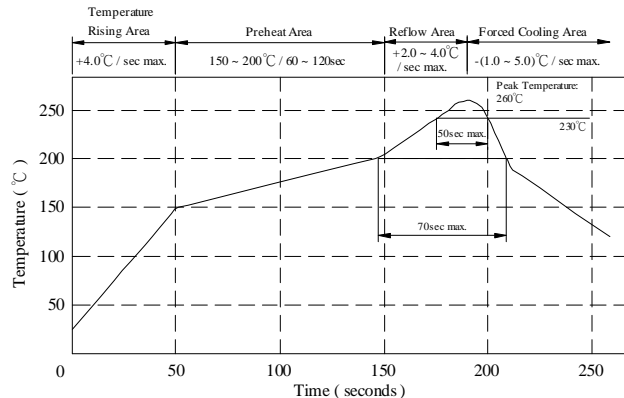

IV . GENERAL SPECIFICATION :

- a . Temp. rise : 40°C max.
- b . Rated current : Base on temp. rise
& $\Delta L / LOA = 10\%$ max.
- c . Storage temp. : -40°C ---- +125°C
- d . Operating temp. : -40°C ---- +105°C
- e . Resistance to solder heat : 260°C .10 secs.

AR-001A

SPECIFICATION FOR APPROVAL

REF : 20090626-A

PAGE: 2

PROD. NAME	SHIELDED SMD POWER INDUCTOR	ABC'S DWG NO.	SS1003□□□□L□-□□□
		ABC'S ITEM NO.	

V . ELECTRICAL CHARACTERISTICS :

DWG No.	Inductance (μH)	Q ref.	Test Freq. (Hz)		RDC (Ω) max	I _{rms} (A) △T=40℃ max	I _{sat} (A) △L/L0A=10% max
			L	Q			
SS10031R8ML□-□□□	1.8±20%	10	1K	7.96 M	0.038	3.00	3.60
SS10032R2ML□-□□□	2.2±20%	11	1K	7.96 M	0.045	2.76	3.40
SS10033R0ML□-□□□	3.0±20%	11	1K	7.96 M	0.062	2.20	2.60
SS10033R9ML□-□□□	3.9±20%	10	1K	7.96 M	0.070	2.10	2.40
SS10034R7ML□-□□□	4.7±20%	10	1K	7.96 M	0.078	1.90	2.30
SS10037R5ML□-□□□	7.5±20%	10	1K	7.96 M	0.100	1.44	1.70
SS1003100ML□-□□□	10.0±20%	18	1K	2.52 M	0.145	1.24	1.50
SS1003120ML□-□□□	12.0±20%	20	1K	2.52 M	0.185	1.10	1.30
SS1003150ML□-□□□	15.0±20%	20	1K	2.52 M	0.200	1.02	1.20
SS1003180ML□-□□□	18.0±20%	20	1K	2.52 M	0.270	0.90	1.10
SS1003220ML□-□□□	22.0±20%	17	1K	2.52 M	0.300	0.80	1.00
SS1003270ML□-□□□	27.0±20%	17	1K	2.52 M	0.400	0.75	0.90
SS1003330ML□-□□□	33.0±20%	17	1K	2.52 M	0.450	0.70	0.85
SS1003390ML□-□□□	39.0±20%	18	1K	2.52 M	0.560	0.65	0.80
SS1003470ML□-□□□	47.0±20%	18	1K	2.52 M	0.650	0.60	0.72
SS1003560ML□-□□□	56.0±20%	15	1K	2.52 M	0.680	0.52	0.65
SS1003680ML□-□□□	68.0±20%	15	1K	2.52 M	0.800	0.48	0.58
SS1003820ML□-□□□	82.0±20%	20	1K	2.52 M	1.200	0.42	0.52
SS1003101ML□-□□□	100.0±20%	23	1K	0.796M	1.400	0.40	0.48
SS1003121ML□-□□□	120.0±20%	22	1K	0.796M	1.520	0.35	0.44
SS1003151ML□-□□□	150.0±20%	23	1K	0.796M	1.800	0.32	0.40
SS1003181ML□-□□□	180.0±20%	20	1K	0.796M	2.200	0.28	0.35
SS1003221ML□-□□□	220.0±20%	20	1K	0.796M	2.200	0.26	0.32
SS1003271YL□-□□□	270.0±15%	26	1K	0.796M	3.100	0.22	0.28
SS1003331YL□-□□□	330.0±15%	26	1K	0.796M	3.600	0.20	0.26
SS1003391YL□-□□□	390.0±15%	28	1K	0.796M	4.600	0.18	0.22
SS1003471YL□-□□□	470.0±15%	28	1K	0.796M	5.100	0.16	0.20

1). □ : Packaging information... Bulk Taping Reel

2). "- □□□ " : Reference code

AR-001A



SPECIFICATION FOR APPROVAL

REF : 20090626-A

PAGE: 3

PROD.	SHIELDED SMD	ABC'S DWG NO.	SS1003□□□□L□-□□□
NAME	POWER INDUCTOR	ABC'S ITEM NO.	

VI . INDUCTANCE VS. DC CURRENT CURVE :

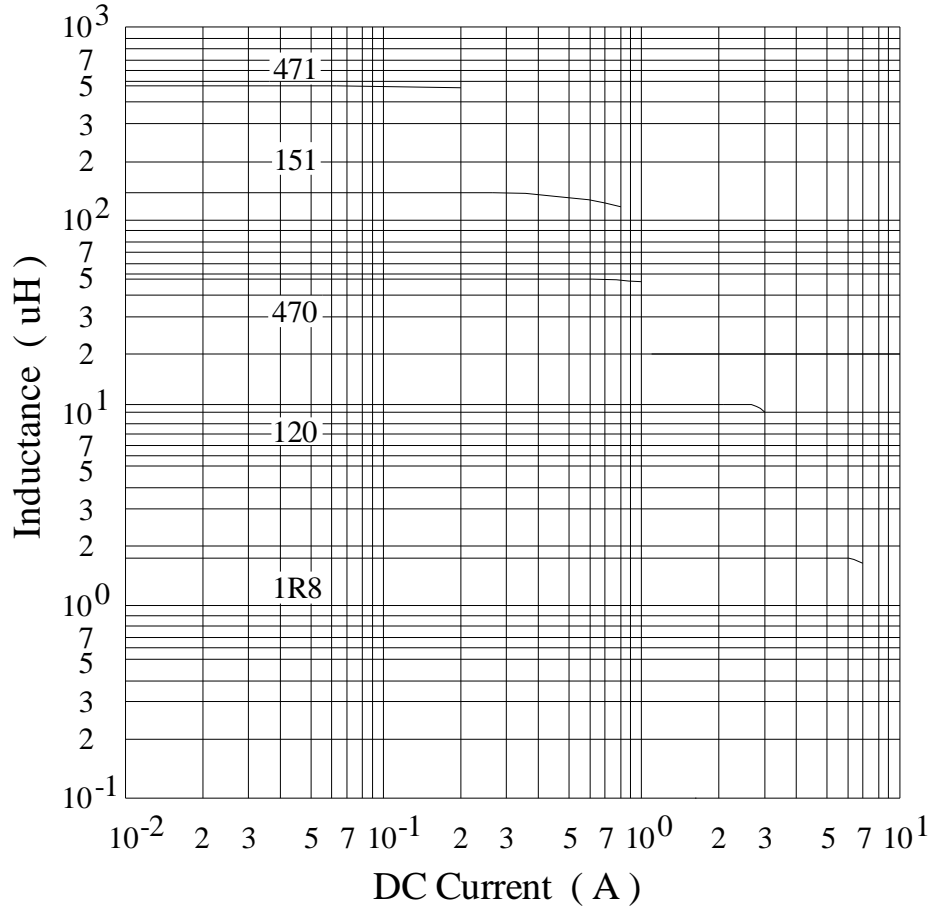

SPECIFICATION FOR APPROVAL

REF : 20090626-A

PAGE: 4

PROD. NAME	SHIELDED SMD POWER INDUCTOR	ABC'S DWG NO. ABC'S ITEM NO.	SS1003□□□□L□-□□
---------------	--------------------------------	---------------------------------	-----------------

VII . PACKAGING INFORMATION :

(1) Configuration

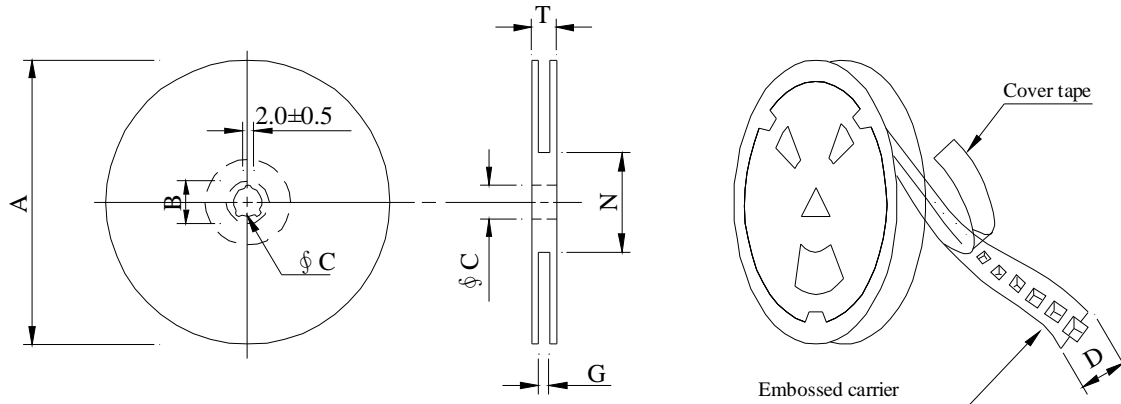

※Carrier tape width : D

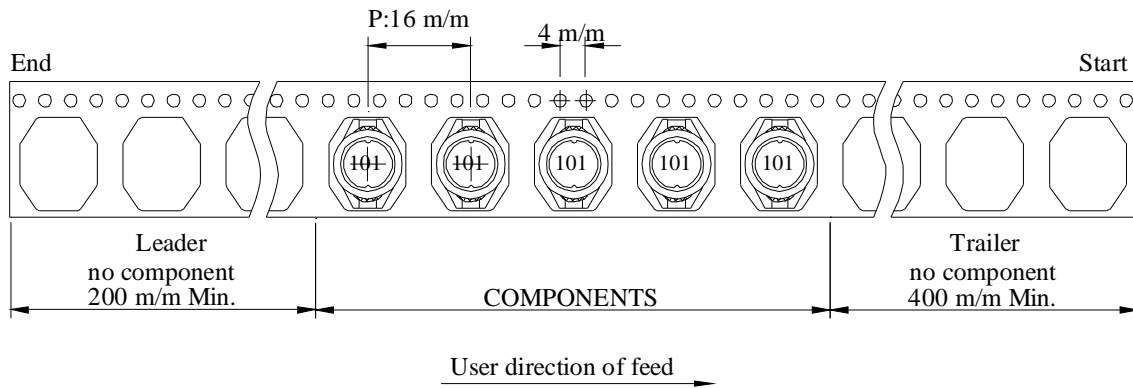

(2) Dimensions

Unit:m/m

Style	A	B	C	D	G	N	T
13 - 24	330	21±0.8	13	24	26 ⁺⁰	50 ⁻⁰	30.4

(3) Q'TY & G.W. Per package

Series	Inner : Reel			Outer : Carton		
	Q'TY (pcs)	G.W. (gw)	Style	Q'TY (pcs)	G.W. (Kg)	Size (cm)
SS1003	1,000	1,000	13 - 24	4,000	6.2	40 x 40 x 24

AR-001A

SPECIFICATION FOR APPROVAL

REF : 20090626-A

PAGE: 5

PROD. NAME	SHIELDED SMD POWER INDUCTOR	ABC'S DWG NO.	SS1003□□□□L□-□□□
		ABC'S ITEM NO.	

VIII . DWGING NUMBER EXPRESSION :

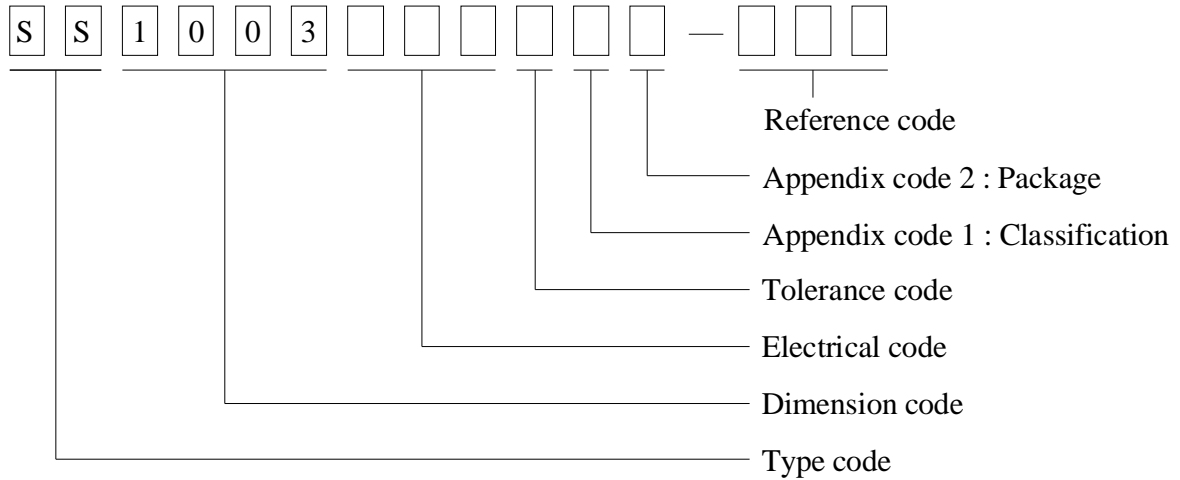

Appendix code 1 : Product Classification

- L : Lead Free Standard products comply with RoHS' requirements
- 1 ~ 9 : Lead Free Special products comply with RoHS' requirements

Appendix code 2 : Package Information

Code	Inner package	Inner package Q'TY	Remark
A	T.B.D.	T.B.D.	
B	T / R (Reel package)	1000 pcs	

SPECIFICATION FOR APPROVAL

REF : 20090626-A

PAGE: 6

PROD. NAME	SHIELDED SMD POWER INDUCTOR	ABC'S DWG NO.	SS1003□□□□L□-□□□
		ABC'S ITEM NO.	

IX . RELIABILITY TEST :

Test item	Specification	Test condition						
Solderability	More than 95% of the terminal electrode shall be covered With fresh solder.	Preheat : 155°C / 4 hours. Solder : Sn96.5 / Ag3 / Cu0.5 or equivalent Solder temp. : 235±5°C Flux : Rosin Dip time : 5±0.5 seconds						
Thermal shock test (Temp. cycle)	Electrical oharacteristics shall not change more than ±20%	<table style="width: 100%; border: none;"> <tr> <td style="text-align: center;">Room temp. 15 minutes</td> <td style="text-align: center; vertical-align: middle;">→</td> <td style="text-align: center;">-40 °C 30 minutes</td> </tr> <tr> <td style="text-align: center;">Room temp. 15 minutes</td> <td style="text-align: center; vertical-align: middle;">→</td> <td style="text-align: center;">+105 °C 30 minutes</td> </tr> </table> <p>Total : 50 cycles</p>	Room temp. 15 minutes	→	-40 °C 30 minutes	Room temp. 15 minutes	→	+105 °C 30 minutes
Room temp. 15 minutes	→	-40 °C 30 minutes						
Room temp. 15 minutes	→	+105 °C 30 minutes						
Humidity Test		Temperature : 40±2°C Humidity : 90±5% Time : 1000 hours						
High temp. Resistance test		Temperature : 105±5°C Applied current : Per spec. Time : 96 hours						

AR-001A



SPECIFICATION FOR APPROVAL

REF : 20090626-A

PAGE: 7

PROD. NAME	SHIELDED SMD POWER INDUCTOR	ABC'S DWG NO.	SS1003□□□□L□-□□□
		ABC'S ITEM NO.	

X . UL CARD :

OBMW2 September 8, 2000

Magnet Wire-Component

JUNG SHING WIRE CO LTD E174837

231 CHUNG CHENG RD, SEC 3 JEN-TEH HSIANG, TAINAN

HSIEN TAIWAN

Mtl Dsg	Mark Dsg	BC	Coat Typ	OC	ANSI Type	Temp Class
AIW	---	Polyamideimide		---	MW81-C	220
CFUEWB	---	Polyurethane		---	MW75C	130
EIAIW	---	Polyesterimide		Polyamideimide	MW35C	200
EILOCKY	---	Polyesterimide		Polyamide	---	180
EILOCKW	---	Polyesterimide		Modified Epoxy	---	200
EIW	---	Polyesterimide		---	---	220
EIW-2	---	Polyesterimide		---	MW74-C	200
FL.EILOCKY	---	Modified Polyester		Polyamide	---	155
LSFFW	---	Polyurethane		---	MW79-C	155
LSUEW	---	Polyurethane		---	---	130
PEW	---	Polyester		---	---	155
PEY	---	Polyester		Nylon	MW24-C	155
SF.FLW	---	Modified Polyester		---	MW26C	155
SF.EIW	---	Polyesterimide		---	MW77C	180
SF.BY@	---	Modified Polyester		Nylon	MW27-C	155
SF.FLY@	---	Modified Polyester		Nylon	MW27-C	155
SF.BLOCKBS	---	Modified Polyester		Modified Polyamide	---	155
SF.EILOCKY#	---	Polyesterimide		Polyamide	---	180
SF.EILOCKBS	---	Polyesterimide		Modified Polyamide	---	180
SF.BW@	---	Modified Polyester		---	MW26C	155
SFFW	---	Polyurethane		---	MW79	155

287806002 Page 1 of 2

A not-for-profit organization
dedicated to public safety and
committed to quality service

Mtl Dsg	Mark Dsg	BC	Coat Typ	OC	ANSI Type	Temp Class
SFFY	---	Polyurethane		Polyamide	MW80C	155
UEW-1	---	Polyurethane		---	MW2-C	105
UEW-2	---	Polyurethane		---	---	130
UEW-4	---	Polyurethane		---	MW75C	130
UEY	---	Polyurethane		Nylon	MW28-C	130
UEY-2	---	Polyurethane		Polyamide	MW28-C	130

@-May be suffixed by LZ; # - May be suffixed by LZ, EL or LZL.
LZ - Signifies magened wires twisted together; EL - signifies base coated magnet wire laid parallel with top coat applied overall; LZL - signi-
fies base coated magnet wire twisted together and covered with top coat overall.

Marking: Company name or trademarks (JSW) or 榮星電線 , material designation or marked designation on packaed or reel, and
Recognized Component Mark.

See General Information Preceding These Recognitions
For use only in equipment where the acceptability of the combination is determined by Underwriters Laboratories Inc.

287806002 Page 2 of 2

OBMW2E174837
September 8 , 2000

AR-001A



SPECIFICATION FOR APPROVAL

REF : 20090626-A

PAGE: 8

PROD. NAME	SHIELDED SMD POWER INDUCTOR	ABC'S DWG NO. ABC'S ITEM NO.	SS1003□□□□L□-□□□
---------------	--------------------------------	---------------------------------	------------------

		SUMITOMO CHEMICAL CO LTD 5-33 KITAHAMA 4-CHOME CHUO-KO, OSAKA JAPAN						E54705 (M)				
Mtl Dsg	Col	Min Thk mm	UL94 Flame Class	Elec	RTI		H W I	H A I	H V T R	D 4 9 5	C T I	
					Mech with Imp	w/o Imp						
Liquid crystal polyester (LCP), designated "EKONOL" or "SUMIKASUPER", furnished in the form of pellets, (Contd)												
E4008 , E400X	NC , BK	0.30	94V-0	130	130	130	—	—	—	—	—	
		0.75	94V-0	130	130	130	3	4	—	—	—	
		1.5	94V-0	130	130	130	2	4	—	—	—	
		3.0	94V-0	130	130	130	1	4	0	5	4	
E4008	NC , WT , BK	0.30	94V-0	130	130	130	—	—	—	—	—	
		0.75	94V-0	220	180	220	3	4	—	—	—	
		1.5	94V-0	220	200	240	2	4	—	—	—	
		3.0	94V-0	220	200	240	1	4	0	5	4	
E4010	NC , BK	0.30	94V-0	130	130	130	—	—	—	—	—	
		0.75	94V-0	220	180	220	3	4	—	—	—	
		1.5	94V-0	220	200	240	2	4	—	—	—	
		3.0	94V-0	220	200	240	1	4	0	5	4	
E400(Y)L , E4008L	NC , BK	0.30	94V-0	130	130	130	—	—	—	—	—	
		0.75	94V-0	130	130	130	3	4	—	—	—	
		1.5	94V-0	130	130	130	2	4	—	—	—	
		3.0	94V-0	130	130	130	1	4	0	5	4	
E4810	NC , BK	0.30	94V-0	130	130	130	—	—	—	—	—	
		0.75	94V-0	130	130	130	0	4	—	—	—	
		1.5	94V-0	130	130	130	0	4	—	—	—	
		3.0	94V-0	130	130	130	1	4	0	5	4	

(X) Denotes any number 1 thru 9.
(Y) Denotes any number 1 thru 7.