



N-Channel Enhancement Mode Field Effect Transistor

PRODUCT SUMMARY

V _{DSS}	I _D	R _{DS(ON)} (mΩ) Max
35V	12A	9 @ V _{GS} = 10V
		13 @ V _{GS} = 4.5V

FEATURES

- Super high dense cell design for low R_{DS(ON)}.
- Rugged and reliable.
- Surface Mount Package.
- ESD Protected.

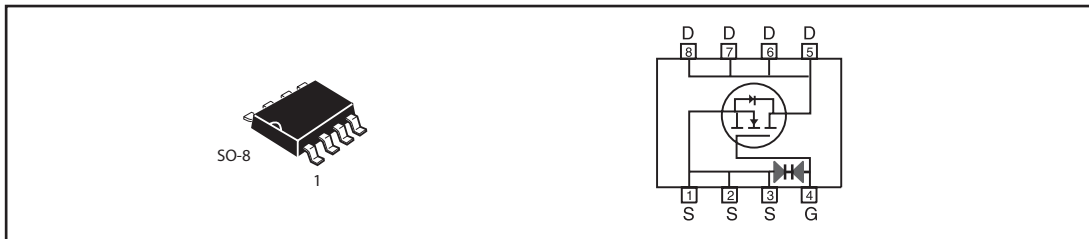

ABSOLUTE MAXIMUM RATINGS (T_A=25°C unless otherwise noted)

Parameter		Symbol	Limit	Unit
Drain-Source Voltage		V _{DS}	35	V
Gate-Source Voltage		V _{GS}	±20	V
Drain Current-Continuous ^a @ T _a	25°C	I _D	12	A
	70°C		9.6	A
-Pulsed ^b		I _{DM}	48	A
Drain-Source Diode Forward Current ^a		I _S	1.7	A
Maximum Power Dissipation ^a	T _a =25°C	P _D	2.5	W
	T _a =70°C		1.6	
Operating Junction and Storage Temperature Range		T _J , T _{STG}	-55 to 150	°C

THERMAL CHARACTERISTICS

Thermal Resistance, Junction-to-Ambient ^a	R _{θJA}	50	°C/W
------------------------------------------------------	------------------	----	------

STM8020

ELECTRICAL CHARACTERISTICS (T_A=25°C unless otherwise noted)

Parameter	Symbol	Condition	Min	Typ ^c	Max	Unit
OFF CHARACTERISTICS						
Drain-Source Breakdown Voltage	BV _{DSS}	V _{GS} = 0V, I _D = 250uA	35			V
Zero Gate Voltage Drain Current	I _{DSS}	V _{DS} = 28V, V _{GS} = 0V			1	uA
Gate-Body Leakage	I _{GSS}	V _{GS} = ±20V, V _{DS} = 0V			±10	uA
ON CHARACTERISTICS^b						
Gate Threshold Voltage	V _{GS(th)}	V _{DS} = V _{GS} , I _D = 250uA	1	1.4	3	V
Drain-Source On-State Resistance	R _{DS(ON)}	V _{GS} = 10V, I _D = 10A		7.2	9	m ohm
		V _{GS} = 4.5V, I _D = 6A		9.5	13	m ohm
On-State Drain Current	I _{D(ON)}	V _{DS} = 10V, V _{GS} = 10V	20			A
Forward Transconductance	g _{FS}	V _{DS} = 10V, I _D = 10A		25		S
DYNAMIC CHARACTERISTICS^c						
Input Capacitance	C _{ISS}	V _{DS} = 20V, V _{GS} = 0V f = 1.0MHz		1400		pF
Output Capacitance	C _{OSS}			255		pF
Reverse Transfer Capacitance	C _{RSS}			145		pF
SWITCHING CHARACTERISTICS^c						
Turn-On Delay Time	t _{D(ON)}	V _{DD} = 15V I _D = 1A V _{GS} = 10V R _{GEN} = 6 ohm		19		ns
Rise Time	t			20		ns
Turn-Off Delay Time	t _{D(OFF)}			77		ns
Fall Time	t			40		ns
Total Gate Charge	Q _g	V _{DS} = 15V, I _D = 10A, V _{GS} = 10V		24		nC
		V _{DS} = 15V, I _D = 10A, V _{GS} = 4.5V		11		nC
Gate-Source Charge	Q _{gs}	V _{DS} = 15V, I _D = 10A V _{GS} = 10V		2.5		nC
Gate-Drain Charge	Q _{gd}			5.5		nC

STM8020

ELECTRICAL CHARACTERISTICS ($T_A=25^{\circ}\text{C}$ unless otherwise noted)

Parameter	Symbol	Condition	Min	Typ ^c	Max	Unit
DRAIN-SOURCE DIODE CHARACTERISTICS^b						
Diode Forward Voltage	V_{SD}	$V_{GS} = 0V, I_S = 1.7A$		0.73	1.2	V

Notes

- a. Surface Mounted on FR4 Board, $t \leq 10\text{sec}$.
- b. Pulse Test: Pulse Width $\leq 300\mu\text{s}$, Duty Cycle $\leq 2\%$.
- c. Guaranteed by design, not subject to production testing.

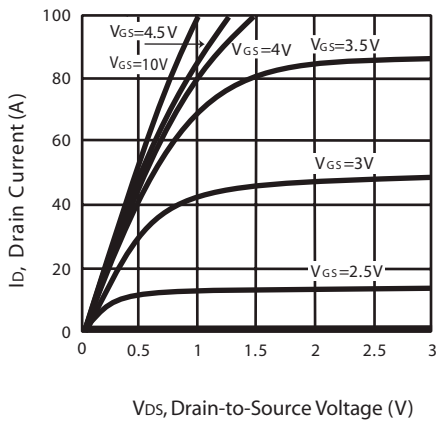

Figure 1. Output Characteristics

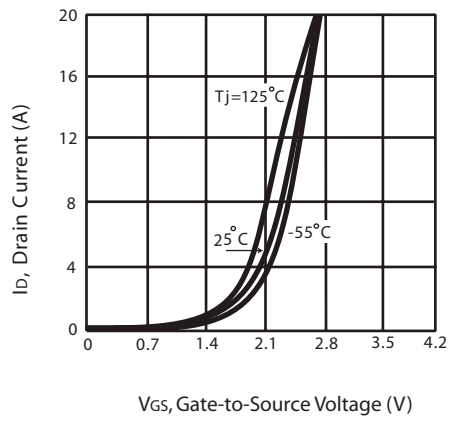

Figure 2. Transfer Characteristics

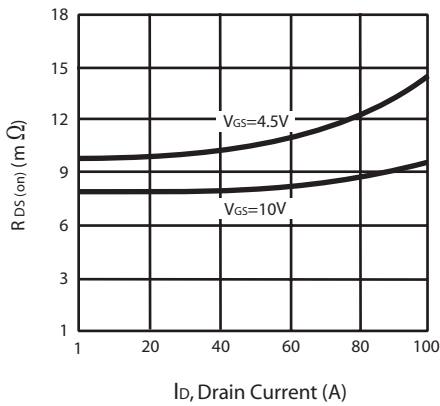

Figure 3. On-Resistance vs. Drain Current and Gate Voltage

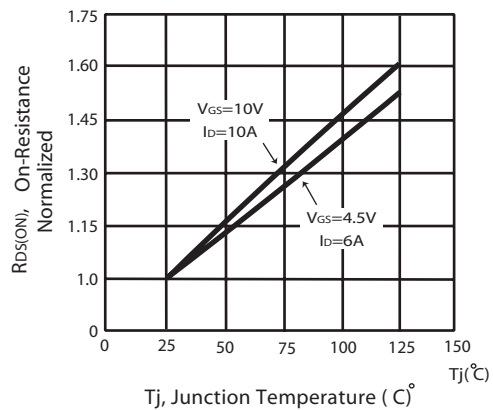

Figure 4. On-Resistance Variation with Drain Current and Temperature

STM8020

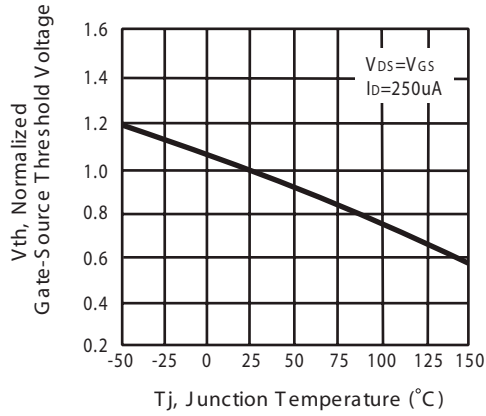

Figure 5. Gate Threshold Variation with Temperature

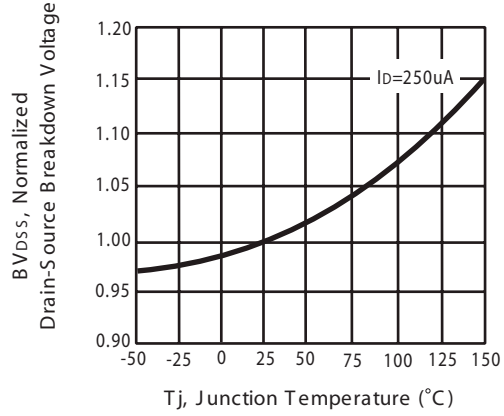

Figure 6. Breakdown Voltage Variation with Temperature

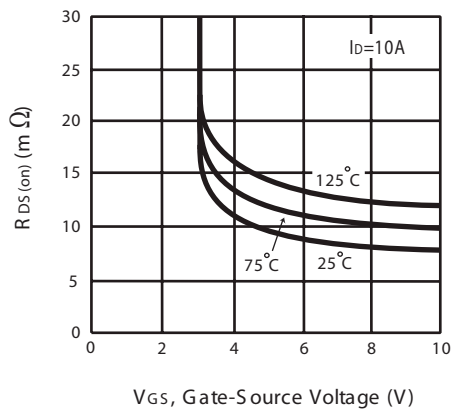

Figure 7. On-Resistance vs. Gate-Source Voltage

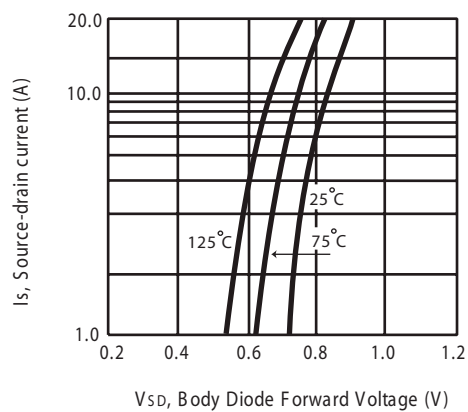

Figure 8. Body Diode Forward Voltage Variation with Source Current

STM8020

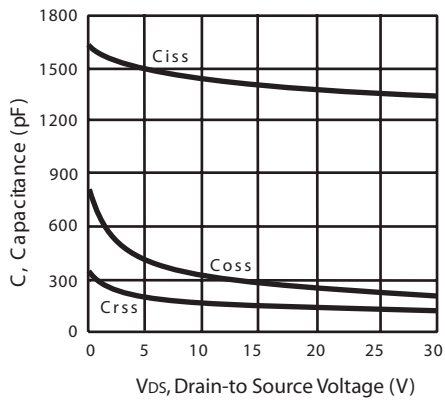

Figure 9. Capacitance

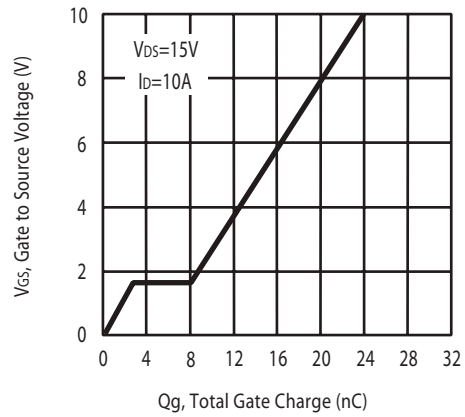

Figure 10. Gate Charge

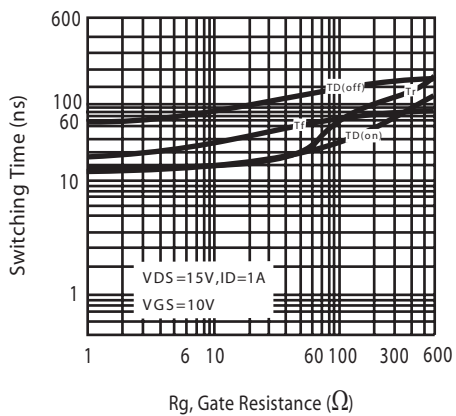

Figure 11. switching characteristics

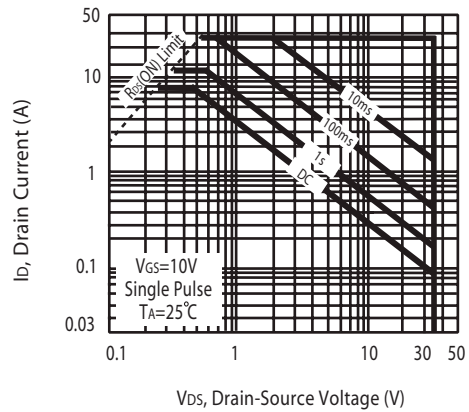
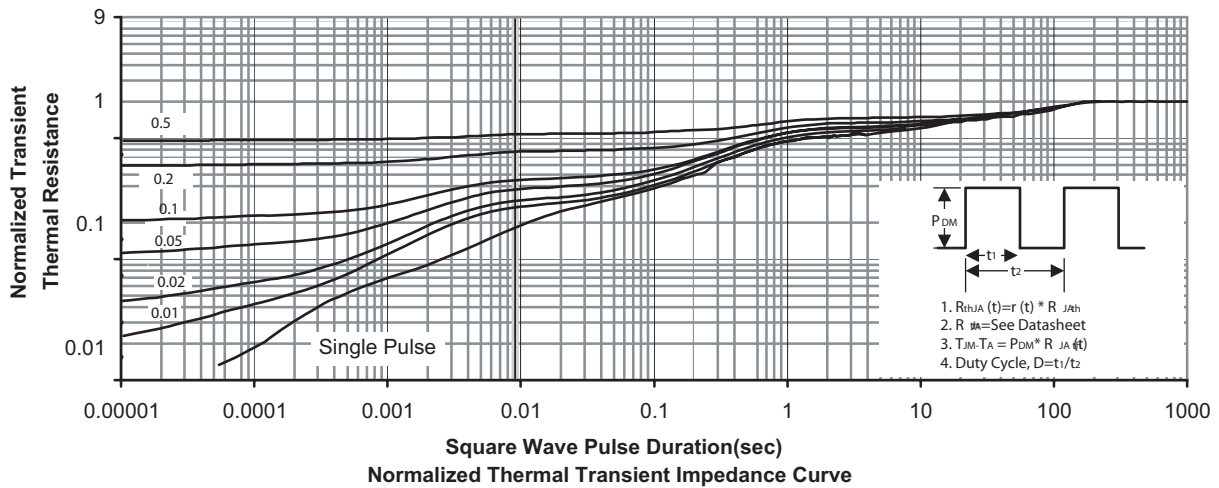

Figure 12. Maximum Safe Operating Area



STM8020

PACKAGE OUTLINE DIMENSIONS

SO-8

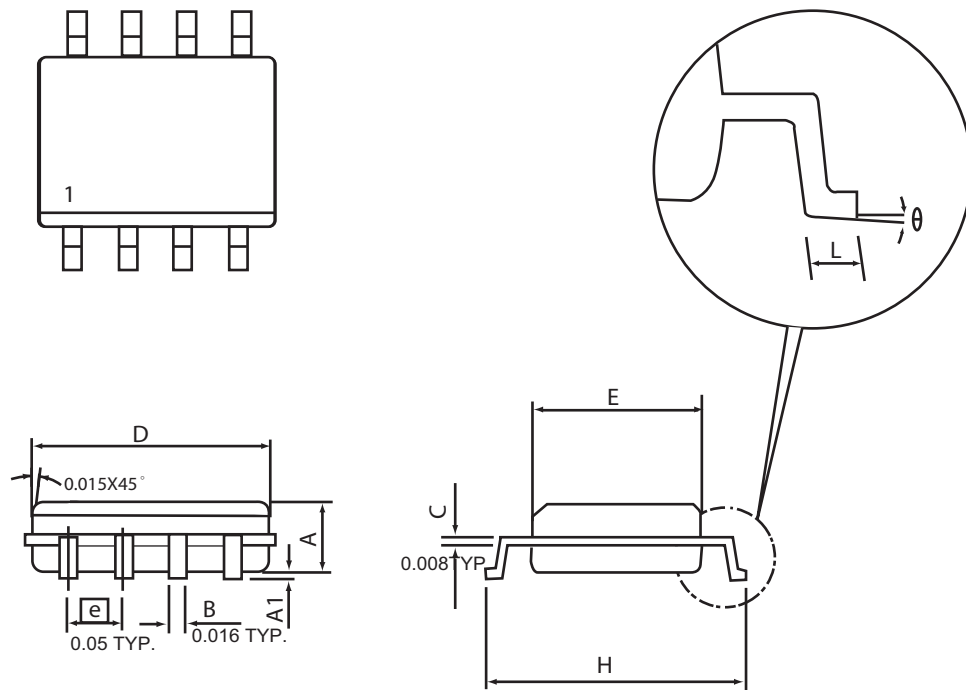

SYMBOLS	MILLIMETERS		INCHES	
	MIN	MAX	MIN	MAX
A	1.35	1.75	0.053	0.069
A1	0.10	0.25	0.004	0.010
D	4.80	4.98	0.189	0.196
E	3.81	3.99	0.150	0.157
H	5.79	6.20	0.228	0.244
L	0.41	1.27	0.016	0.050
θ	0°	8°	0°	8°

STM8020

SO-8 Tape and Reel Data

SO-8 Carrier Tape

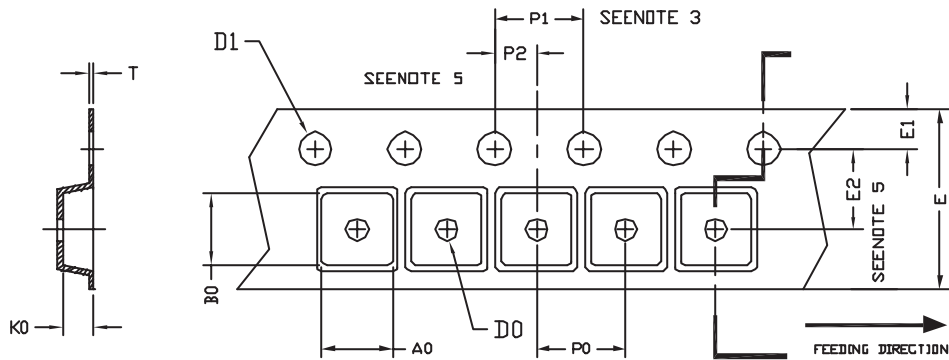

unit:mm

PACKAGE	A0	B0	K0	D0	D1	E	E1	E2	P0	P1	P2	T
SOP 8N 150mil	6.40	5.20	2.10	ϕ 1.5 (MIN)	ϕ 1.5 + 0.1 - 0.0	12.0 \pm 0.3	1.75	5.5 \pm 0.05	8.0	4.0	2.0 \pm 0.05	0.3 \pm 0.05

SO-8 Reel

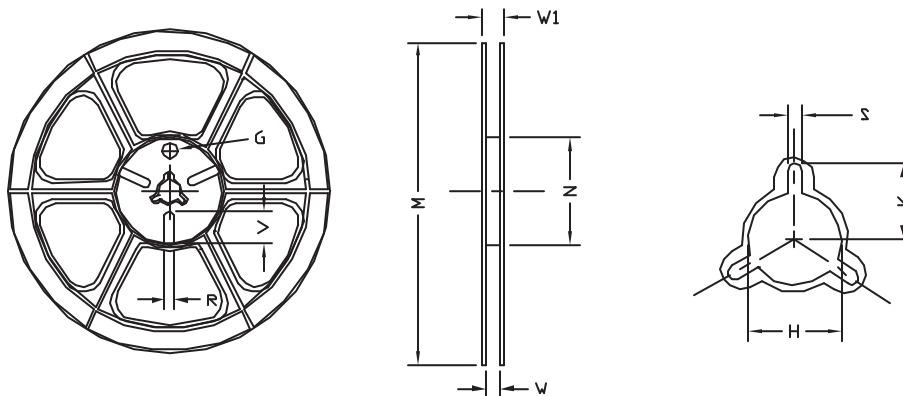

UNIT:mm

TAPE SIZE	REEL SIZE	M	N	W	W1	H	K	S	G	R	V
12 mm	ϕ 330	330 \pm 1	62 \pm 1.5	12.4 + 0.2	16.8 - 0.4	ϕ 12.75 + 0.15	---	2.0 \pm 0.15	---	---	---