

Ultra High Precision Z-Foil Voltage Divider and Network Resistor with TCR Tracking to 0.1 ppm/°C and Resistance Match to ± 0.005% (50 ppm)

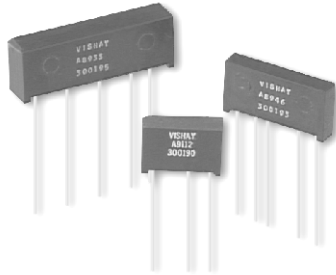

Any value at any tolerance available within resistance range

INTRODUCTION

The 2R, 3R, 4R Resistor Networks are the designers first choice for ultra high precision, stable and reliable Voltage Divider or Network.

The Z-Foil Technology provides a significant reduction of the resistive components sensitivity to ambient temperature variations (TCR) and applied power changes, self-heating (PCR): 0.05 ppm/°C Absolute TCR removes errors due to temperature gradients.

The 2R, 3R, 4R provide a unique, inherent combination of performance characteristics resulting in excellent performance and high reliability, satisfying the needs of today's expanding requirements.

The availability of low absolute TCR and low PCR, provides a good cost solution for the variability of other components when compiling the total error budget.

Our Application Engineering Department is available to advise and to make recommendations for non-standard technical requirements and special applications, please do not hesitate to contact us.

FEATURES

- Resistance Range each resistor: 1Ω to 150KΩ (Any ohmic value ratio is available within resistance range)
- Non Inductive/Capacitive design
- Low Temperature Coefficient of Resistance (TCR) Absolute:
 - ± 0.05 ppm/°C (Industrial range)
 - ± 0.2 ppm/°C (MIL range), Tracking 0.1 ppm/°C
- Power Coefficient "ΔR due to self heating": 5 ppm at rated power
- Tolerance: Absolute and Resistance Match to 0.005%
- Resistance Ratio Stability: at 0.05W @ + 25°C to 0.001%
- Electrostatic Discharge (ESD) above 25 000 Volts
- Short time overload ≤ 0.002%
- Power Rating at + 125°C: 0.3W
- Thermal EMF: 0.05μV/°C
- Non hot spot design
- Current Noise: < - 40dB
- Rise time: 1ns without ringing
- Non Inductive: < 0.08μH
- Voltage Coefficient < 0.1 ppm/V
- For better performances please contact us
- Terminal Finishes available:
 - Lead (Pb)-free
 - Tin/Lead Alloy



FIGURE 1 - POWER DERATING CURVE

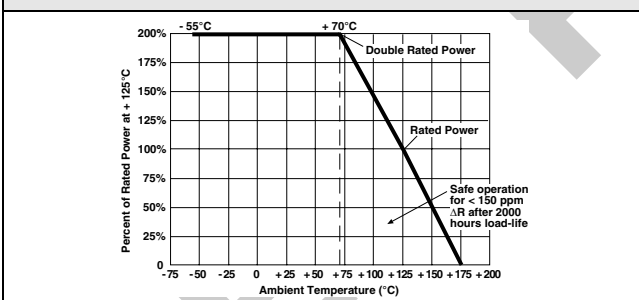
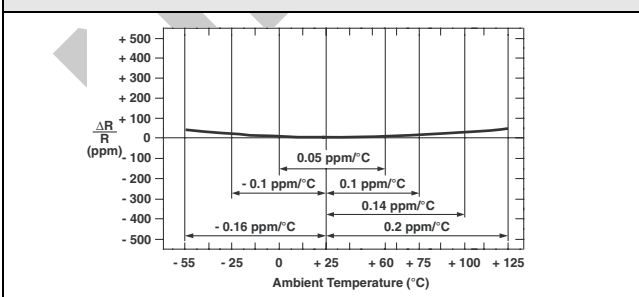

FIGURE 2 - TYPICAL TCR CURVE Z-FOIL



APPLICATIONS

- Instrumentation Amplifiers
- Bridge Networks
- Differential Amplifiers
- Military, Airborne and Space
- EB Applications
- Down-Hole (high temperature)
- Medical
- Automatic Test Equipment (ATE)

FIGURE 3 - TRIMMING TO VALUES CONCEPTUAL ILLUSTRATION)

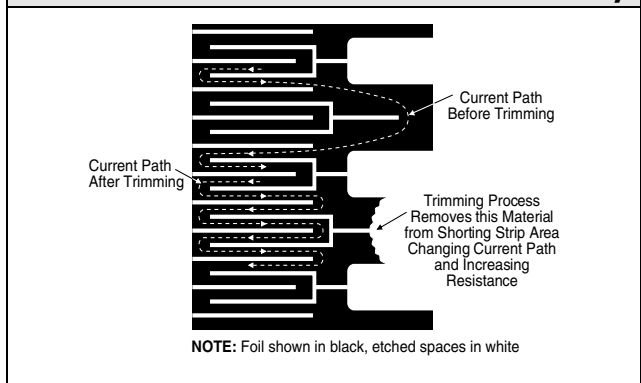

SALES

- AMERICAS: foilsales.usa@vishay.com
- ASIA/JAPAN: foilsales.asia@vishay.com
- UK/HOLLAND/SCANDINAVIA: foilsales.eunorth@vishay.com
- GERMANY/CZECH REPUBLIC/AUSTRIA: foilsales.eucentral@vishay.com
- FRANCE/SWITZERLAND/SOUTHERN EUROPE: foilsales.eusouth@vishay.com
- ISRAEL: foilsales.israel@vishay.com



2R, 3R, 4R (Z-Foil Technology)

Ultra High Precision Z-Foil Voltage Divider and Network Resistor with TCR Tracking to 0.1 ppm/°C and Resistance Match to ± 0.005% (50 ppm)

Vishay Foil Resistors

TABLE 1 - TYPICAL PERFORMANCE CHARACTERISTICS*

TCR Tracking between all resistors (Any ohmic value ratio is available within resistance range)	available to: typical maximum	0.1 ppm/°C 0.5 ppm/°C depends on resistance value
Ratio Tolerance between all resistors	available to:	0.005 % (50 ppm) depends on resistance value
Max Ambient Temp. at Rated Wattage		+ 125°C
Max Ambient Temp. at Zero Power		+ 175°C
Thermal Shock	ΔR ΔRatio	0.002% (20 ppm) 0.002% (20 ppm)
Low Temperature Operation	ΔR ΔRatio	0.005% (50 ppm) 0.002% (20 ppm)
Short Time Overload	ΔR ΔRatio	0.002% (20 ppm) 0.002% (20 ppm)
Terminal Strength	ΔR ΔRatio	0.001% (10 ppm) 0.001% (10 ppm)
Resistance to Soldering Heat	ΔR ΔRatio	0.002% (20 ppm) 0.001% (10 ppm)
Moisture Resistance	ΔR ΔRatio	0.003% (30 ppm) 0.003% (30 ppm)
Shock	ΔR ΔRatio	0.001% (10 ppm) 0.001% (10 ppm)
Vibration High Frequency	ΔR ΔRatio	0.001% (10 ppm) 0.001% (10 ppm)
Life	ΔR ΔRatio	0.01% (100 ppm)
0.3W at + 125°C	ΔR ΔRatio	0.01% (100 ppm)
0.02W at + 60°C	ΔR ΔRatio	0.003% (30 ppm)
0.05W at + 25°C	ΔR ΔRatio	0.001% (10 ppm)
	ΔR ΔRatio	0.002% (20 ppm)
	ΔR ΔRatio	0.001% (10 ppm)
High Temperature Exposure	ΔR ΔRatio	0.01% (100 ppm) 0.01% (100 ppm)
Low Temperature Storage	ΔR ΔRatio	0.002% (20 ppm) 0.002% (20 ppm)
Insulation Resistance		> 10 ⁴ MΩ
Dielectric Withstanding Voltage		No Change
Voltage Coefficient	ΔR ΔRatio	0.1ppm/V 0.1ppm/V
Noise	N/A	- 40dB
Inductance	N/A	0.08μH
Capacitance	N/A	0.5pF
Rise Time	N/A	1ns at 1kΩ
Thermal EMF lead to lead	N/A	0.04μV/°C
Thermal EMF air circulation	N/A	0.02μV/°C
Thermal EMF power	N/A	0.1μV for 20mW
Shelf Life	ΔR ΔRatio	25 ppm/year 10 ppm/year

* Measurement error 0.001 R

SALES

• AMERICAS: foilsales.usa@vishay.com • ASIA/JAPAN: foilsales.asia@vishay.com • UK/HOLLAND/SCANDINAVIA: foilsales.eunorth@vishay.com
 • GERMANY/CZECH REPUBLIC/AUSTRIA: foilsales.eucentral@vishay.com • FRANCE/SWITZERLAND/SOUTHERN EUROPE: foilsales.eusouth@vishay.com • ISRAEL: foilsales.israel@vishay.com

2R, 3R, 4R (Z-Foil Technology)



Vishay Foil Resistors

Ultra High Precision Z-Foil Voltage Divider and Network Resistor with TCR Tracking to 0.1 ppm/°C and Resistance Match to ± 0.005% (50 ppm)

FIGURE 4 - VISHAY MODEL 300198 NETWORK

APPLICATION EXAMPLE

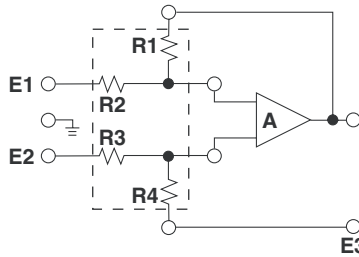
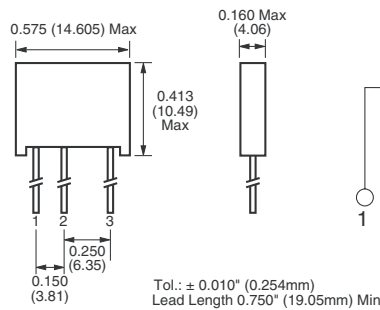
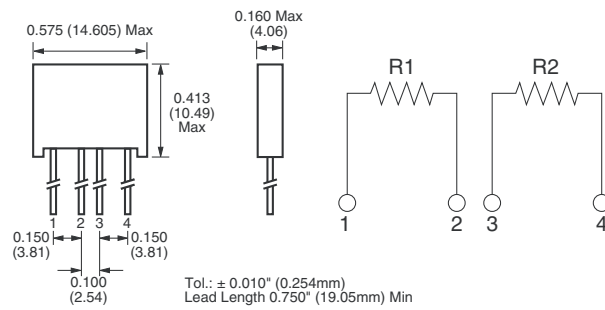

FIGURE 5 - MOLDED 2R, 3R, 4R RESISTOR NETWORK DIMENSIONS AND CIRCUIT DESIGN in inches (millimeters)

MODEL 300190Z (with Z-Foil Technology)



MODEL 300191Z (with Z-Foil Technology)



MODEL 300192Z (with Z-Foil Technology)

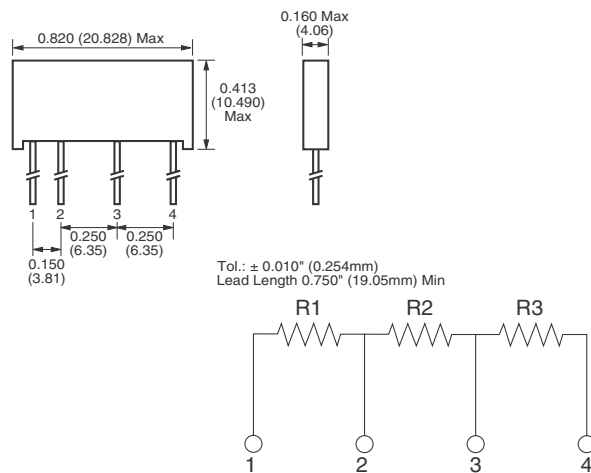

MODEL 300193Z (with Z-Foil Technology)

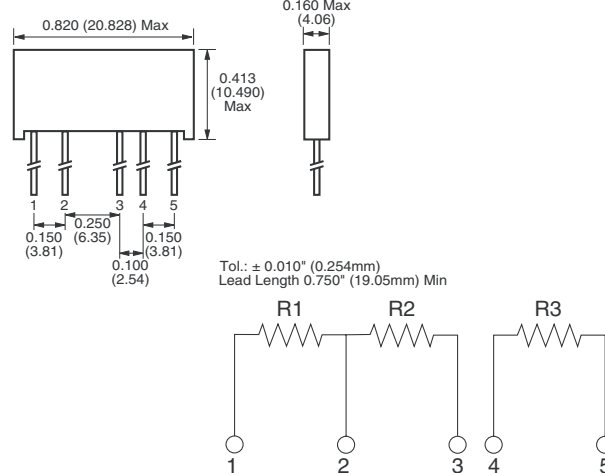

SALES

- AMERICAS: foilsales.usa@vishay.com
- ASIA/JAPAN: foilsales.asia@vishay.com
- UK/HOLLAND/SCANDINAVIA: foilsales.eunorth@vishay.com
- GERMANY/CZECH REPUBLIC/AUSTRIA: foilsales.eucentral@vishay.com
- FRANCE/SWITZERLAND/SOUTHERN EUROPE: foilsales.eusouth@vishay.com
- ISRAEL: foilsales.israel@vishay.com



2R, 3R, 4R (Z-Foil Technology)

Ultra High Precision Z-Foil Voltage Divider and Network Resistor with TCR Tracking to 0.1 ppm/°C and Resistance Match to ±0.005% (50 ppm)

Vishay Foil Resistors

FIGURE 6 - MOLDED 2R, 3R, 4R RESISTOR NETWORK DIMENSIONS AND CIRCUIT DESIGN in inches (millimeters)

**MODEL 300194Z
(with Z-Foil Technology)**

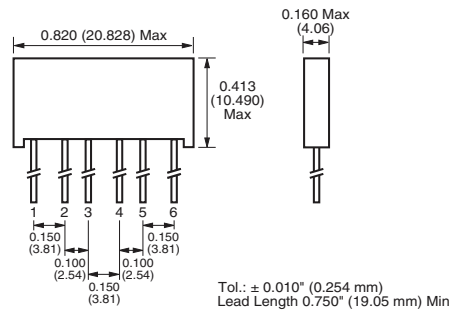

**MODEL 300195Z
(with Z-Foil Technology)**

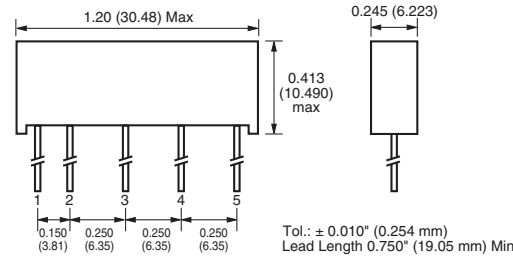

**MODEL 300196Z
(with Z-Foil Technology)**

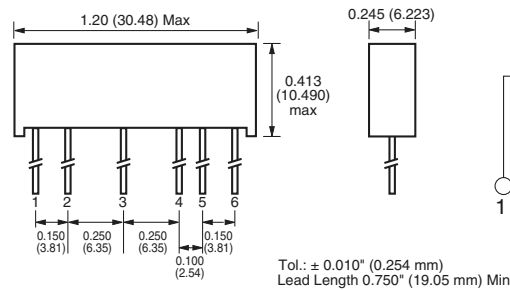

**MODEL 300197Z
(with Z-Foil Technology)**

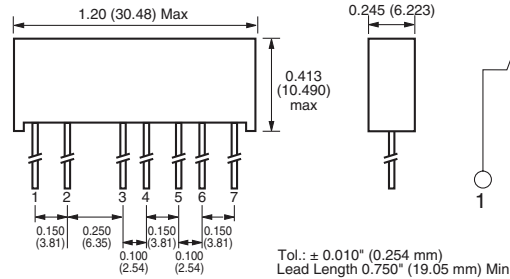

**MODEL 300198Z
(with Z-Foil Technology)**

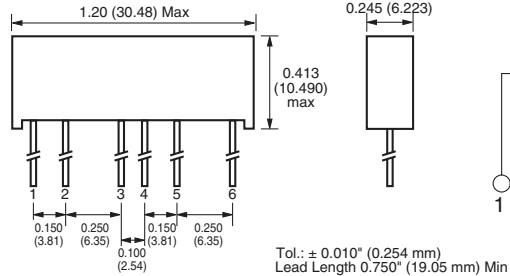

SALES

- AMERICAS: foilsales.usa@vishay.com
- ASIA/JAPAN: foilsales.asia@vishay.com
- UK/HOLLAND/SCANDINAVIA: foilsales.eunorth@vishay.com
- GERMANY/CZECH REPUBLIC/AUSTRIA: foilsales.eucentral@vishay.com
- FRANCE/SWITZERLAND/SOUTHERN EUROPE: foilsales.eusouth@vishay.com
- ISRAEL: foilsales.israel@vishay.com

2R, 3R, 4R (Z-Foil Technology)



Vishay Foil Resistors

Ultra High Precision Z-Foil Voltage Divider and Network Resistor with TCR Tracking to 0.1 ppm/°C and Resistance Match to ±0.005% (50 ppm)

FIGURE 7 - MOLDED 2R, 3R, 4R RESISTOR NETWORK DIMENSIONS AND CIRCUIT DESIGN in inches (millimeters)

MODEL 300199Z (with Z-Foil Technology)

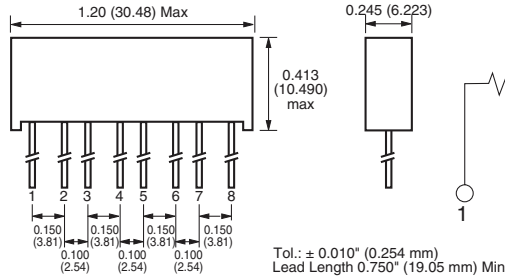

MODEL 300210Z (with Z-Foil Technology)

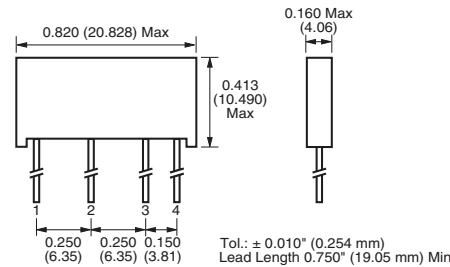

MODEL 300211Z (with Z-Foil Technology)

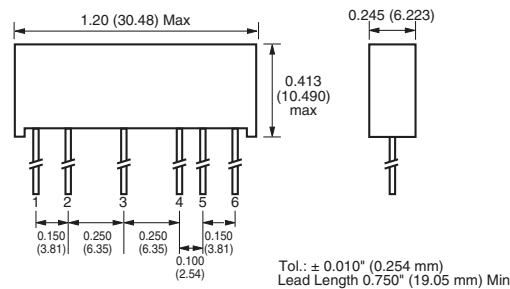

MODEL 300212Z (with Z-Foil Technology)

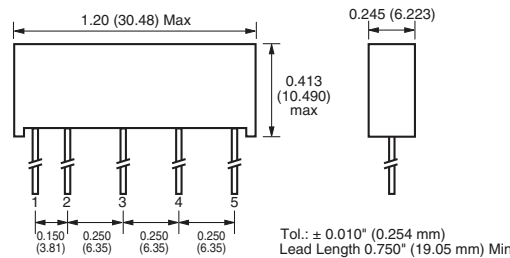

ORDERING INFORMATION - MOLDED 2R, 3R AND 4R RESISTOR NETWORKS WITH Z-FOIL TECHNOLOGY

Networks are built to your requirements. Send your schematic and electrical requirements to the Applications Engineering Department. (foil@vishay.com) A unique part number will be assigned which defines all aspects of your network.

SALES

- AMERICAS: foilsales.usa@vishay.com
- ASIA/JAPAN: foilsales.asia@vishay.com
- UK/HOLLAND/SCANDINAVIA: foilsales.eunorth@vishay.com
- GERMANY/CZECH REPUBLIC/AUSTRIA: foilsales.eucentral@vishay.com
- FRANCE/SWITZERLAND/SOUTHERN EUROPE: foilsales.eusouth@vishay.com
- ISRAEL: foilsales.israel@vishay.com



Disclaimer

All product specifications and data are subject to change without notice.

Vishay Intertechnology, Inc., its affiliates, agents, and employees, and all persons acting on its or their behalf (collectively, "Vishay"), disclaim any and all liability for any errors, inaccuracies or incompleteness contained herein or in any other disclosure relating to any product.

Vishay disclaims any and all liability arising out of the use or application of any product described herein or of any information provided herein to the maximum extent permitted by law. The product specifications do not expand or otherwise modify Vishay's terms and conditions of purchase, including but not limited to the warranty expressed therein, which apply to these products.

No license, express or implied, by estoppel or otherwise, to any intellectual property rights is granted by this document or by any conduct of Vishay.

The products shown herein are not designed for use in medical, life-saving, or life-sustaining applications unless otherwise expressly indicated. Customers using or selling Vishay products not expressly indicated for use in such applications do so entirely at their own risk and agree to fully indemnify Vishay for any damages arising or resulting from such use or sale. Please contact authorized Vishay personnel to obtain written terms and conditions regarding products designed for such applications.

Product names and markings noted herein may be trademarks of their respective owners.