

# MADP-042XX8-13060 Series



**SURMOUNT™ 8μM PIN Diodes**  
RoHS Compliant

M/A-COM Products  
Rev. V1

## Features

- Surface Mount
- No Wirebonds Required
- Rugged Silicon-Glass Construction
- Silicon Nitride Passivation
- Polymer Scratch Protection
- Low Parasitic Capacitance and Inductance
- High Average and Peak Power Handling
- RoHS Compliant

## Description

This device is a silicon, glass PIN diode surmount chip fabricated with M/A-COM's patented HMIC™ process. This device features two silicon pedestals embedded in a low loss, low dispersion glass. The diode is formed on the top of one pedestal and connections to the backside of the device are facilitated by making the pedestal sidewalls electrically conductive. Selective backside metallization is applied producing a surface mount device. This vertical topology provides for exceptional heat transfer. The topside is fully encapsulated with silicon nitride and has an additional polymer layer for scratch and impact protection. These protective coatings prevent damage to the junction and the anode air-bridge during handling and assembly.

## Applications

These packageless devices are suitable for moderate incident power applications,  $\leq 10W/C.W.$  or where the peak power is  $\leq 52W$ , pulse width is  $\leq 1\mu S$ , and duty cycle is  $\leq 0.01\%$ . Their low parasitic inductance, 0.4 nH, and excellent RC constant, make these devices a superior choice for higher frequency switch elements when compared to their plastic package counterparts.

## Absolute Maximum Ratings<sup>1</sup> @ T<sub>AMB</sub> = +25°C (unless otherwise specified)

Parameter	Absolute Maximum				
	MADP-042...-13060	308	408	508	908
C.W. Incident Power dBm	+42	+44	+43	+39	
Forward Current	250 mA				
Reverse Voltage	-100 V				
Operating Temperature	-55°C to +125°C				
Storage Temperature	-55°C to +150°C				
Junction Temperature	+175°C				
Mounting Temperature	+280°C for 10 seconds				

1. Exceeding these limits may cause permanent damage.

**ADVANCED:** Data Sheets contain information regarding a product M/A-COM is considering for development. Performance is based on target specifications, simulated results, and/or prototype measurements. Commitment to develop is not guaranteed.

**PRELIMINARY:** Data Sheets contain information regarding a product M/A-COM has under development. Performance is based on engineering tests. Specifications are typical. Mechanical outline has been fixed. Engineering samples and/or test data may be available. Commitment to produce in volume is not guaranteed.

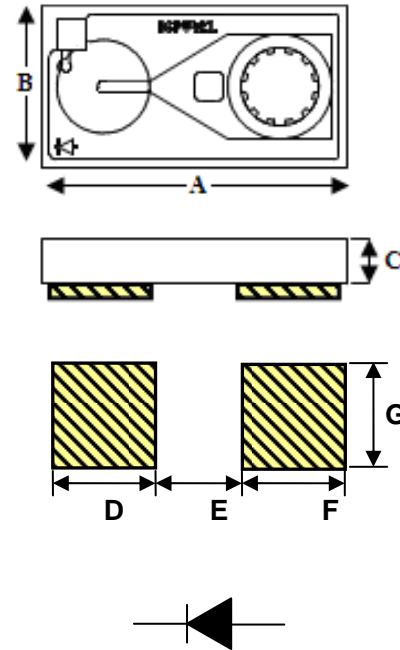

DIM	INCHES		MM	
	MIN	MAX	MIN	MAX
A	0.040	0.042	1.025	1.075
B	0.021	0.023	0.525	0.575
C	0.004	0.008	0.102	0.203
D	0.013	0.015	0.325	0.375
E	0.011	0.013	0.275	0.325
F	0.013	0.015	0.325	0.375
G	0.019	0.021	0.475	0.525

## Notes:

1. Backside metal: 0.1 μm thick.
2. Yellow hatched areas indicate backside ohmic gold contacts.
3. All devices have the same outline dimensions ( A to G).

• **North America** Tel: 800.366.2266 / Fax: 978.366.2266  
 • **Europe** Tel: 44.1908.574.200 / Fax: 44.1908.574.300  
 • **Asia/Pacific** Tel: 81.44.844.8296 / Fax: 81.44.844.8298

Visit [www.macom.com](http://www.macom.com) for additional data sheets and product information.

M/A-COM Inc. and its affiliates reserve the right to make changes to the product(s) or information contained herein without notice.

# MADP-042XX8-13060 Series



**SURMOUNT™ 8μM PIN Diodes**  
RoHS Compliant

M/A-COM Products  
Rev. V1

## Electrical Specifications @ T<sub>AMB</sub> = + 25 °C

Parameter	Symbol	Conditions	Units	MADP-042308-13060		MADP-042508-13060	
				Typ	Max	Typ	Max
Capacitance	C <sub>T</sub> <sup>1,3</sup>	- 10V, 1 MHz <sup>1</sup>	pF	0.10	0.20	0.18	0.30
Capacitance	C <sub>T</sub> <sup>1,3</sup>	- 10 V, 1 GHz <sup>1,3</sup>	pF	0.10		0.19	
Capacitance	C <sub>T</sub> <sup>1,3</sup>	- 40 V, 1 MHz <sup>1</sup>	pF	0.09	0.20	0.18	0.30
Capacitance	C <sub>T</sub> <sup>1,3</sup>	- 40 V, 1 GHz <sup>1,3</sup>	pF	0.10		0.18	
Resistance	R <sub>S</sub> <sup>2,3</sup>	+ 20 mA, 1 GHz <sup>2,3</sup>	W	1.38		0.97	
Resistance	R <sub>S</sub> <sup>2,3</sup>	+ 50 mA, 1 GHz <sup>2,3</sup>	W	1.18		0.87	
Forward Voltage	V <sub>F</sub>	+ 10 mA	V	0.85	1.00	0.82	1.00
Reverse Leakage Current	I <sub>R</sub>	-100V	μA		10		10
Input Third Order Intercept Point	IIP <sup>3</sup>	F 1= 1000 MHz F2 = 1010 MHz Input Power = +20 dBm I bias = + 20 mA	dBm	73		77	
C.W. Thermal Resistance	θ		°C/W	145		115	
Lifetime	T <sub>L</sub>	+10 mA / -6 mA ( 50% - 90% V )	nS	280		310	

Parameter	Symbol	Conditions	Units	MADP-042408-13060		MADP-042908-13060	
				Typ.	Max	Typ	Max
Capacitance	C <sub>T</sub> <sup>1,3</sup>	- 10 V, 1 MHz <sup>1</sup>	pF	0.38	0.50	0.05	0.15
Capacitance	C <sub>T</sub> <sup>1,3</sup>	- 10 V, 1 GHz <sup>1,3</sup>	pF	0.39		0.05	
Capacitance	C <sub>T</sub> <sup>1,3</sup>	- 40 V, 1 MHz <sup>1</sup>	pF	0.36	0.50	0.04	0.15
Capacitance	C <sub>T</sub> <sup>1,3</sup>	- 40 V, 1 GHz <sup>1,3</sup>	pF	0.37		0.05	
Resistance	R <sub>S</sub> <sup>2,3</sup>	+ 20 mA, 1 GHz <sup>2,3</sup>	W	0.67		3.63	
Resistance	R <sub>S</sub> <sup>2,3</sup>	+ 50 mA, 1 GHz <sup>2,3</sup>	W	0.61		3.02	
Forward Voltage	V <sub>F</sub>	+ 10 mA	V	0.80	1.00	0.91	1.00
Reverse Leakage Current	I <sub>R</sub>	-100V	μA		10		10
Input Third Order Intercept Point	IIP <sup>3</sup>	F 1= 1000 MHz F2 = 1010 MHz Input Power = +20 dBm I bias = + 20 mA	dBm	81		66	
C.W. Thermal Resistance	θ <sup>4</sup>		°C/W	100		185	
Lifetime	T <sub>L</sub>	+10 mA / -6 mA ( 50% - 90% V )	nS	380		230	

1. Total capacitance, C<sub>T</sub>, is equivalent to the sum of junction capacitance, C<sub>J</sub>, and parasitic capacitance, C<sub>par</sub>.
2. Series resistance R<sub>S</sub> is equivalent to the total diode resistance : R<sub>S</sub> = R<sub>J</sub> ( Junction Resistance ) + R<sub>C</sub> ( Ohmic Resistance )
3. R<sub>S</sub> and C<sub>T</sub> are measured on an HP4291A Impedance Analyzer with die mounted in an ODS-1134 package.
4. Theta (θ) is measured with the die mounted in an ODS-1134 package.

### Specifications Subject to Change Without Notice.

**ADVANCED:** Data Sheets contain information regarding a product M/A-COM is considering for development. Performance is based on target specifications, simulated results, and/or prototype measurements. Commitment to develop is not guaranteed.

**PRELIMINARY:** Data Sheets contain information regarding a product M/A-COM has under development. Performance is based on engineering tests. Specifications are typical. Mechanical outline has been fixed. Engineering samples and/or test data may be available. Commitment to produce in volume is not guaranteed.

- **North America** Tel: 800.366.2266 / Fax: 978.366.2266
- **Europe** Tel: 44.1908.574.200 / Fax: 44.1908.574.300
- **Asia/Pacific** Tel: 81.44.844.8296 / Fax: 81.44.844.8298

Visit [www.macom.com](http://www.macom.com) for additional data sheets and product information.

M/A-COM Inc. and its affiliates reserve the right to make changes to the product(s) or information contained herein without notice.

# MADP-042XX8-13060 Series



**SURMOUNT™ 8μm PIN Diodes**  
RoHS Compliant

M/A-COM Products  
Rev. V1

## Typical Performance @ T<sub>AMB</sub> = +25 °C

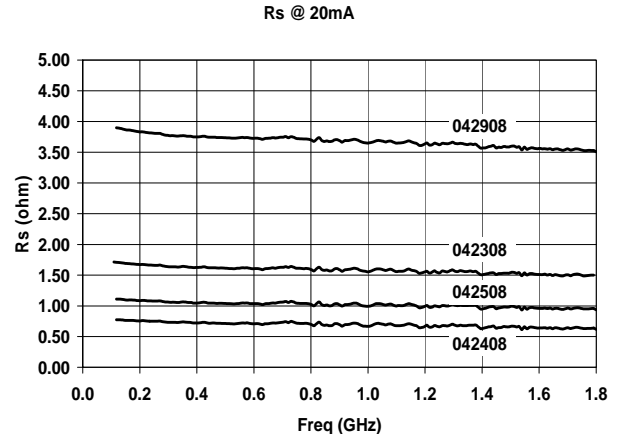
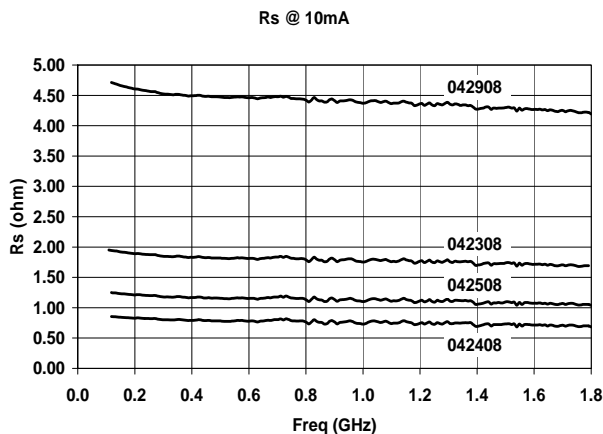
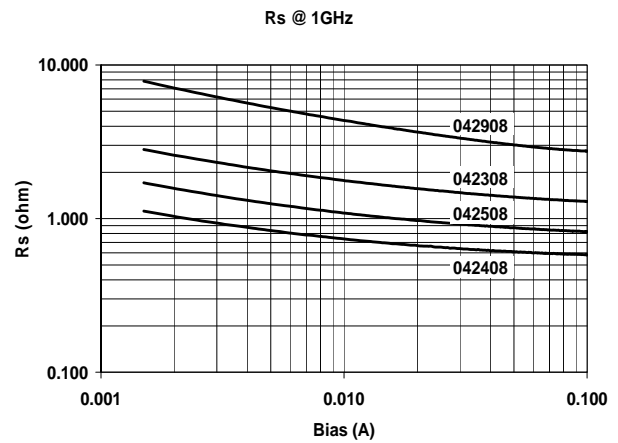
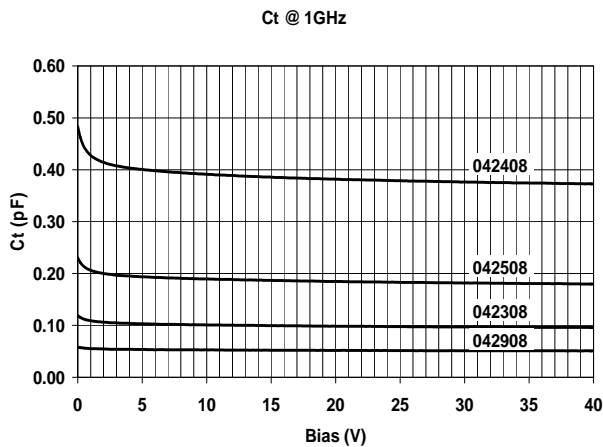
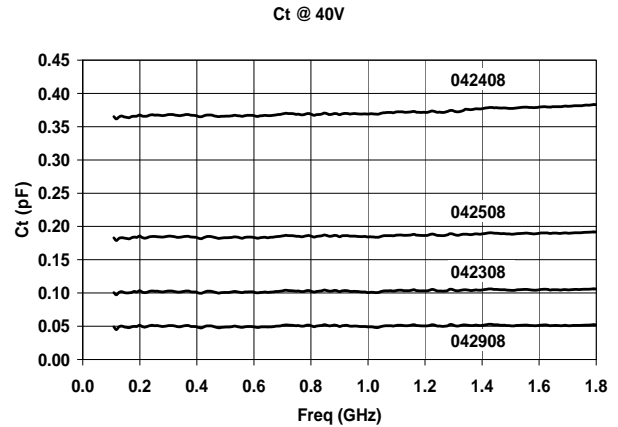
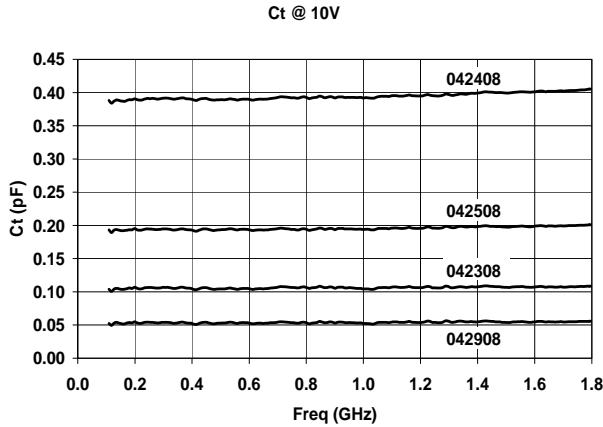

**ADVANCED:** Data Sheets contain information regarding a product M/A-COM is considering for development. Performance is based on target specifications, simulated results, and/or prototype measurements. Commitment to develop is not guaranteed.

**PRELIMINARY:** Data Sheets contain information regarding a product M/A-COM has under development. Performance is based on engineering tests. Specifications are typical. Mechanical outline has been fixed. Engineering samples and/or test data may be available. Commitment to produce in volume is not guaranteed.

- **North America** Tel: 800.366.2266 / Fax: 978.366.2266
- **Europe** Tel: 44.1908.574.200 / Fax: 44.1908.574.300
- **Asia/Pacific** Tel: 81.44.844.8296 / Fax: 81.44.844.8298

Visit [www.macom.com](http://www.macom.com) for additional data sheets and product information.

M/A-COM Inc. and its affiliates reserve the right to make changes to the product(s) or information contained herein without notice.

# MADP-042XX8-13060 Series



SURMOUNT™ 8μM PIN Diodes  
RoHS Compliant

M/A-COM Products  
Rev. V1

## Handling Procedures

All semiconductor chips should be handled with care to avoid damage or contamination from perspiration and skin oils. The use of plastic tipped tweezers or vacuum pickups is strongly recommended for individual components. Bulk handling should insure that abrasion and mechanical shock are minimized.

## Bonding Techniques

Attachment to a circuit board is made simple through the use of surface mount technology. Mounting pads are conveniently located on the bottom surface of these devices and are removed from the active junction locations. These devices are well suited for solder attachment onto hard and soft substrates. The use of 80Au/20Sn, or RoHS compliant solders is recommended. For applications where the average power is ~1W, conductive silver epoxy may also be used. Cure per manufacturers recommended time and temperature. Typically 1 hour at 150°C.

When soldering these devices to a hard substrate, hot gas die bonding is preferred. A vacuum tip pick-up tool and a force of 60 to 100 grams applied to the top surface of the device is recommended. When soldering to soft substrates, such as Duroid, it is recommended to use a soft solder at the circuit board to mounting pad interface. Position the die so that its mounting pads are aligned with the circuit board mounting pads. While applying a downward force perpendicular to the top surface of the die, apply heat near the circuit trace and diode mounting pad. The solder connection to the two pads should not be made one at a time as this will create unequal heat flow and thermal stress to the part. Solder reflow should not be performed by causing heat to flow through the top surface of the die to the back. Since the HMIC glass is transparent, the edges of the mounting pads can be visually inspected through the die after attachment is completed.

Typical re-flow profiles for Sn60/Pb40 and RoHS compliant solders is provided in [Application Note M538](#), "Surface Mounting Instructions" and can be viewed on the M/A-COM website @ [www.macom.com](http://www.macom.com)

## Ordering Information

The MADP-042XX8-13060 series of surmounts may be ordered in either gel packs or tape and reeled by adding the appropriate suffix per the table below. Tape and reel dimensions are provided in [Application Note M513](#) located on the M/A-COM website @ [www.macom.com](http://www.macom.com).

Part Number		
Gel Pack	Tape and Reel (Surf Tape)	Tape and Reel (Pocket Tape)
MADP-042308-13060G	MADP-042308-13060T	MADP-042308-13060P
MADP-042408-13060G	MADP-042408-13060T	MADP-042408-13060P
MADP-042508-13060G	MADP-042508-13060T	MADP-042508-13060P
MADP-042908-13060G	MADP-042908-13060T	MADP-042908-13060P

**ADVANCED:** Data Sheets contain information regarding a product M/A-COM is considering for development. Performance is based on target specifications, simulated results, and/or prototype measurements. Commitment to develop is not guaranteed.

**PRELIMINARY:** Data Sheets contain information regarding a product M/A-COM has under development. Performance is based on engineering tests. Specifications are typical. Mechanical outline has been fixed. Engineering samples and/or test data may be available. Commitment to produce in volume is not guaranteed.

- **North America** Tel: 800.366.2266 / Fax: 978.366.2266
- **Europe** Tel: 44.1908.574.200 / Fax: 44.1908.574.300
- **Asia/Pacific** Tel: 81.44.844.8296 / Fax: 81.44.844.8298

Visit [www.macom.com](http://www.macom.com) for additional data sheets and product information.

M/A-COM Inc. and its affiliates reserve the right to make changes to the product(s) or information contained herein without notice.