

“LAN-MATE” SERIES

SINGLE RJ45 CONNECTOR MODULE WITH INTEGRATED 1000 BASE-T MAGNETICS AND LEDS

P/N:LA1E109D-34 LF

Page : 1/2

Feature

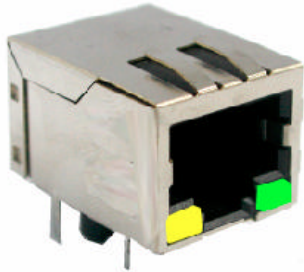

- RJ-45 needs to be matched FCC standard
- Isolation @ 60Hz : Input to output:1500Vrms.
- Lead free for external pins.
- Comply with RoHS requirements-whole part No Cd, No Hg, No Cr6+, No PBB and PBDE and No Pb on external pins.
- Operating temperature range: 0 to +70 .
- Storage temperature range: -25 to +85 .
- Recommended panel

Part Number	Standard LED	Forward*V(Max)	(TYP)
3	YELLOW	2.6V	2.1V
4	GREEN	2.6V	2.2V

*with a forward current of 20mA

Electrical Specifications @ 25°C							
Part Number	Turns Ratio (±5%)		OCL(uH Min) @100KHz/0.1V with 8mA DC Bias	Cross talk (dB Min)			HI-POT (Vrms)
	TX	RX		0.3-30MHz	30-60MHz	60-100MHz	
LA1E109D-34 LF	1CT:1CT	1CT:1CT	350	-40	-35	-30	1500

Continue								
Part Number	Insertion Loss (dB Max)	Return Loss (dB Min) @ Load 100				CMR (dB Min)		
		1-100MHz	1-30MHz	30-40MHz	40-50MHz	50-80MHz	1-30MHz	30-60MHz
LA1E109D-34 LF	-1.0	-16	-13.5	-11.5	-10	-30	-25	-20

Schematic

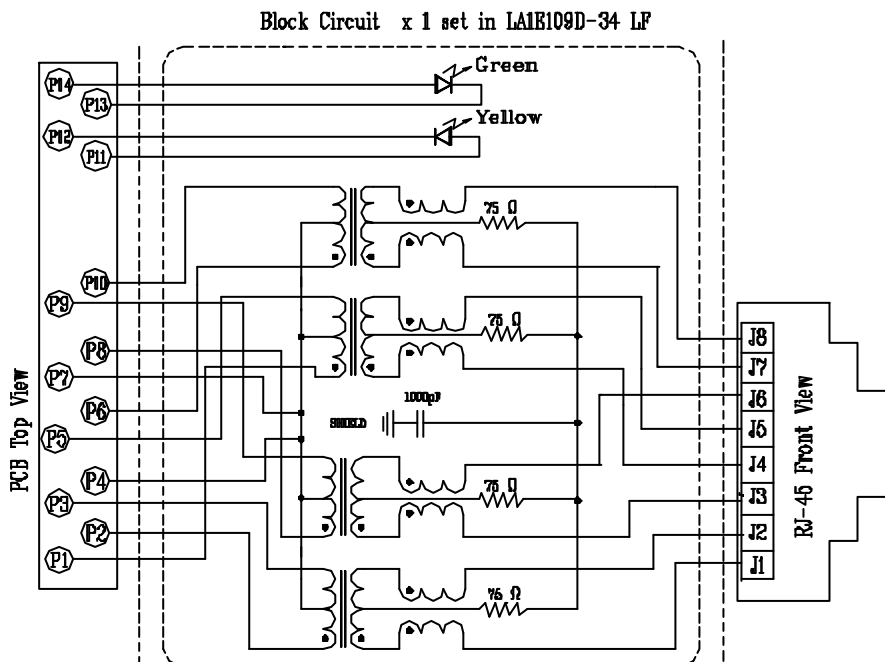

“LAN-MATE” SERIES

SINGLE RJ45 CONNECTOR MODULE WITH INTEGRATED 1000 BASE-T MAGNETICS AND LEDS

P/N:LA1E109D-34 LF

Mechanical

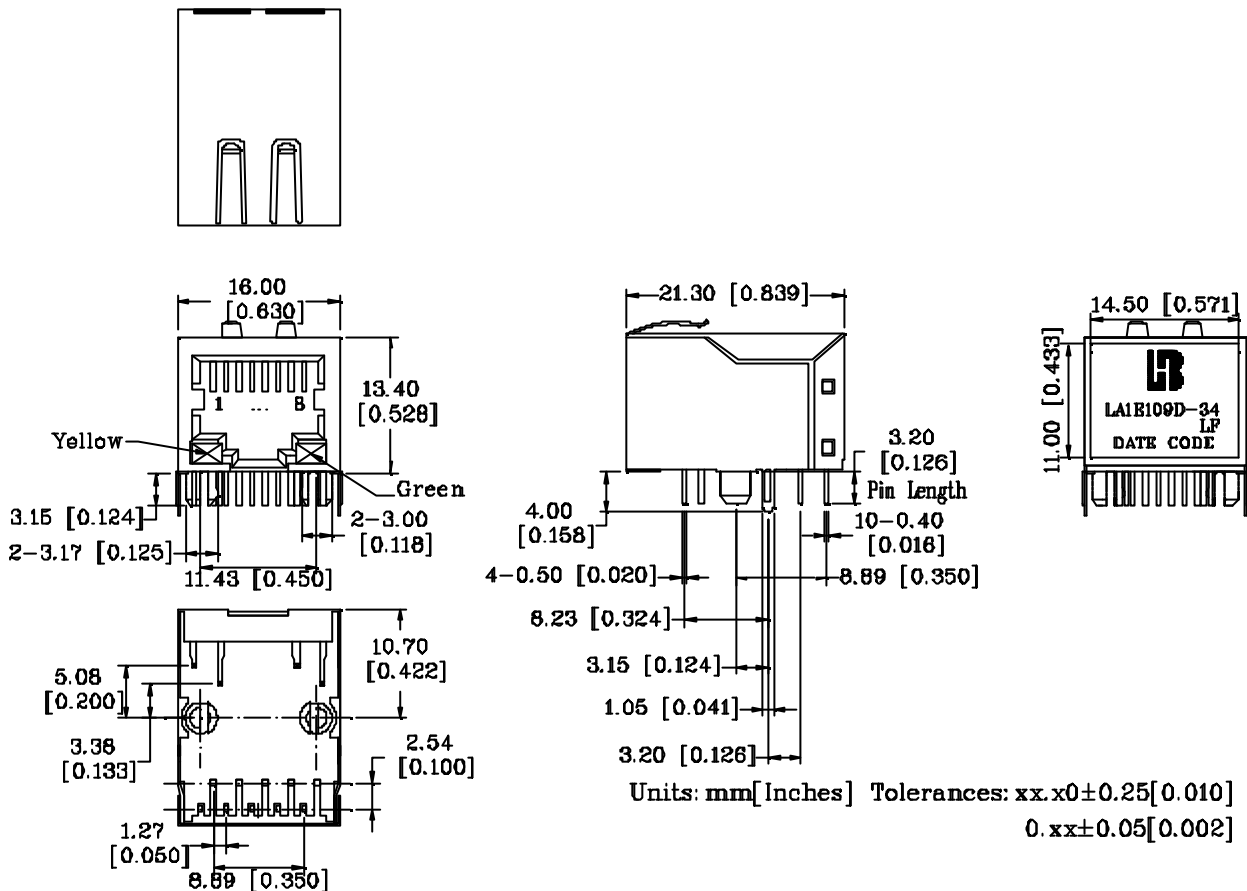

- 1. Plastic Material : Thermoplastic (UL 94V-0), Black Housing
- 2. Metal Shield : Brass, 20u" inches thick Nickel
- 3. Spring Wire : Phosphor bronze with selective gold plating
- 4. Solder Pin : 0.4x0.4mm, Phosphor bronze with solder Plated
- 5. Durability : 750 Mating cycles Min.

PCB Layout Mounting Hole(Top View)

