

1X4 RJ45 CONNECTOR MODULE WITH INTEGRATED 10/100 BASE-TX MAGNETICS

P/N: LU4T041A1X

Feature



- Complies with requirement of IEEE802.3u standards.
- RJ 45 connector with 10/100 BASE-TX magnetic.
- Operating temperature range: 0°C to +70°C.
- Storage temperature range: -25°C to +125°C.

Electrical Specifications @ 25°C

Part Number	Turns Ratio (±5%) TX/RX	OCL (uH Min) @ 100 KHz/0.1V with 8mA DC Bias	C _{w/w} (pF Max)	L.L (uH Max)	Cross talk (dB Min)			HI-POT (Vrms)
					0.3-30MHz	30-60MHz	60-100 MHz	
LU4T041A1X	1CT:1CT	350	28	0.4	-40	-35	-30	1500

Continue

Part Number	Insertion Loss (dB Max)	Return Loss (dB Min)					CMR (dB Min) TX/RX		
		0.3-100MHz	30MHz	40MHz	50MHz	60MHz	80MHz	1-30MHz	30-60MHz
LU4T041A1X	-1.15	-16	-14	-13.5	-13	-10	-30	-25	-20

Schematic

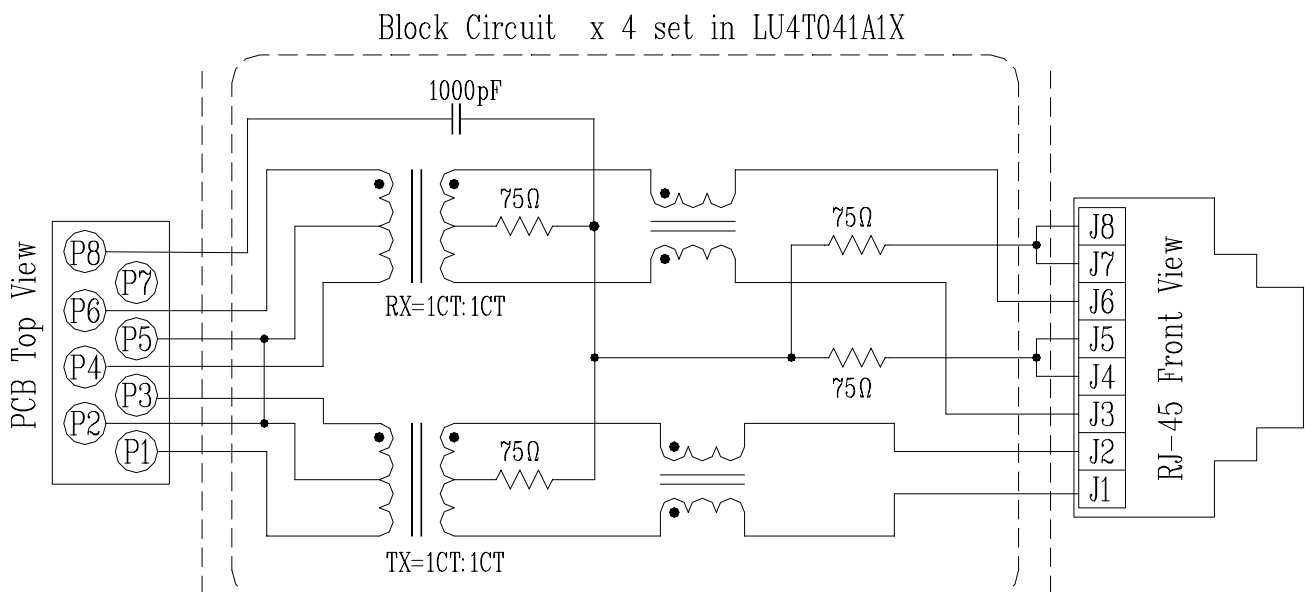

1X4 RJ45 CONNECTOR MODULE WITH INTEGRATED 10/100 BASE-TX MAGNETICS

P/N: LU4T041A1X

Mechanical

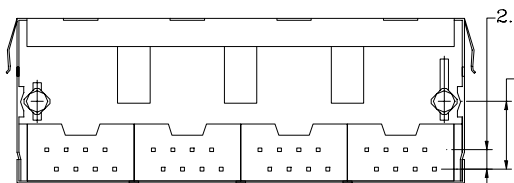
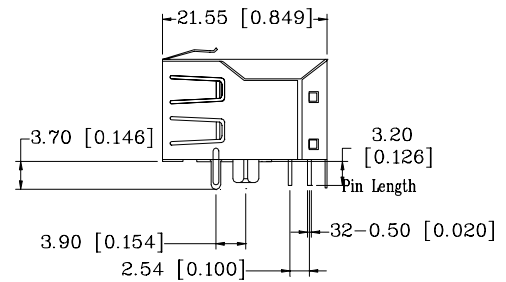
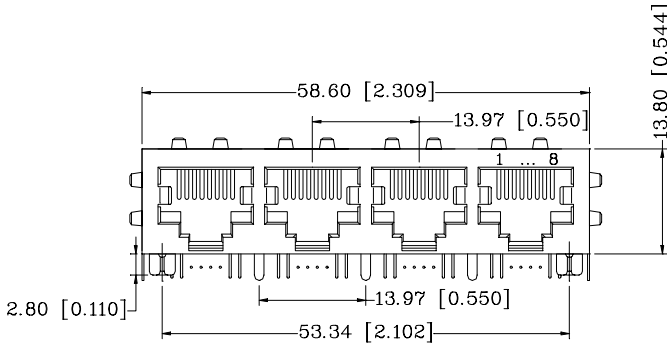
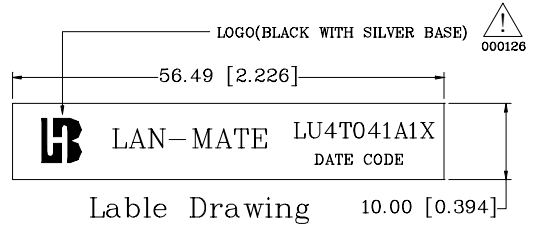
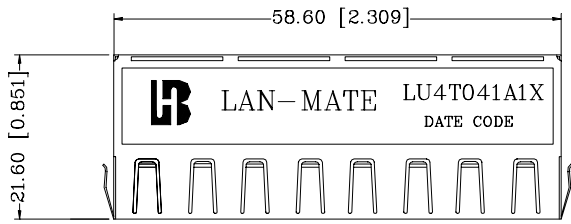

Units: mm[Inches]

Tolerances: xx.x0±0.25[0.010]

0.xx±0.05[0.002]

- 1. Plastic Material : PBT 15% Glass Filled(UL 94V-0), Black Housing
- 2. Metal Shield : Brass C2680-H, 20u Nickel Plated, t=0.25mm
- 3. Spring Wire : 0.45mm Dia. Phosphor bronze with 6u gold plated
- 4. Solder Pin : 0.4x0.4mm, Phosphor bronze with solder Plated
- 5. Durability : 300 Mating cycles Min.

PCB Layout Mounting Hole(Top View)

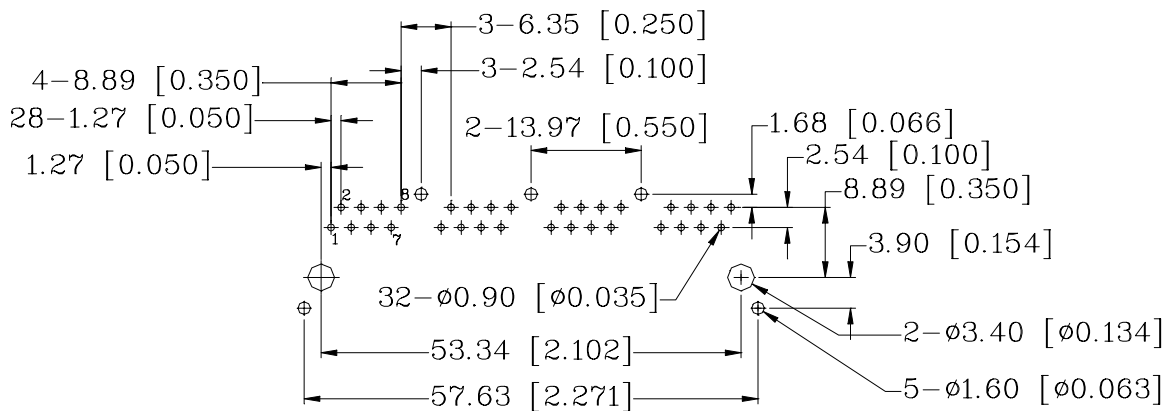

Units: mm[Inches] Tolerances: xx.x0±0.25[0.010]

0.xx±0.05[0.002]